

DDR SDRAM DIMM

MT4VDDT864A – 64MB
MT4VDDT1664A – 128MB
MT4VDDT3264A – 256MB

For the latest data sheet, please refer to the Micron® Web site: www.micron.com/products/modules

Features

- JEDEC standard 184-pin, unbuffered dual in-line memory module (DDR DIMM)
- Utilizes 266 MT/s and 333MT/s DDR SDRAM components
- Fast data transfer rates: PC2100 or PC2700
- 64MB (8 Meg x 64), 128MB (16 Meg x 64), and 256MB (32 Meg x 64)
- VDD= VDDQ= +2.5V
- VDDSPD = +2.3V to +3.6V
- 2.5V I/O (SSTL_2 compatible)
- Commands entered on each positive CK edge
- DQS edge-aligned with data for READs; center-aligned with data for WRITEs
- Internal, pipelined double data rate (DDR) architecture; two data accesses per clock cycle
- Bidirectional data strobe (DQS) transmitted/received with data—i.e., source-synchronous data capture
- Differential clock inputs (CK and CK#)
- Four internal device banks for concurrent operation
- Selectable burst lengths: 2, 4, or 8
- Auto precharge option
- Auto Refresh and Self Refresh Modes: 15.625µs (64MB); 7.8125µs (128MB, 256MB) maximum average periodic refresh interval.
- Serial Presence Detect (SPD) with EEPROM
- Selectable READ CAS latency for maximum compatibility
- Gold edge contacts

Figure 1: 184-Pin DIMM (MO-206)

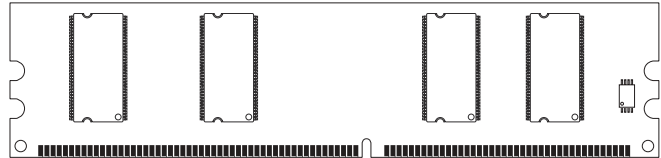

OPTIONS

- Operating Temperature Range

Commercial (0°C to +70°C)	None
Industrial (-40°C to +85°C) ¹	I
- Package

184-pin DIMM (Standard)	G
184-Pin DIMM (Lead-free) ¹	Y
- Memory Clock, Speed, CAS Latency²

6ns, 333 MT/s (167 MHz), CL = 2.5	-335
7.5ns, 266 MT/s (133 MHz), CL = 2	-262 ¹
7.5ns, 266 MT/s (133 MHz), CL = 2	-26A ¹
7.5ns, 266 MT/s (133 MHz), CL = 2.5	-265
- PCB

1.25in. (31.75mm)	See page 2 note
-------------------	-----------------

MARKING

NOTE: 1. Consult Micron for product availability.
2. CL = Device CAS (READ) Latency.

Table 1: Address Table

	64MB	128MB	256MB
Refresh Count	4K	8K	8K
Row Addressing	4K (A0–A11)	8K(A0–A12)	8K(A0–A12)
Device Bank Addressing	4 (BA0, BA1)	4 (BA0, BA1)	4 (BA0, BA1)
Device Configuration	128Mb (8 Meg x 16)	256Mb (16 Meg x 16)	512Mb (32 Meg x 16)
Column Addressing	512 (A0–A8)	512 (A0–A8)	1K (A0–A9)
Module Rank Addressing	1 (S0#)	1 (S0#)	1 (S0#)



Table 2: Part Numbers and Timing Parameters

PART NUMBER	MODULE DENSITY	CONFIGURATION	MODULE BANDWIDTH	MEMORY CLOCK, DATA RATE	CLOCK LATENCY (CL - t _{RCD} - t _{RP})
MT4VDDT864A(I)G-335__	64MB	8 Meg x 64	2.7GB/s	6ns, 333MT/s	2.5-3-3
MT4VDDT864A(I)Y-335__	64MB	8 Meg x 64	2.7GB/s	6ns, 333MT/s	2.5-3-3
MT4VDDT864A(I)G-262__	64MB	8 Meg x 64	2.1GB/s	7.5ns, 266MT/s	2-2-2
MT4VDDT864A(I)Y-262__	64MB	8 Meg x 64	2.1GB/s	7.5ns, 266MT/s	2-2-2
MT4VDDT864A(I)G-26A__	64MB	8 Meg x 64	2.1GB/s	7.5ns, 266MT/s	2-3-3
MT4VDDT864A(I)Y-26A__	64MB	8 Meg x 64	2.1GB/s	7.5ns, 266MT/s	2-3-3
MT4VDDT864A(I)G-265__	64MB	8 Meg x 64	2.1GB/s	7.5ns, 266 MT/s	2.5-3-3
MT4VDDT864A(I)Y-265__	64MB	8 Meg x 64	2.1GB/s	7.5ns, 266 MT/s	2.5-3-3
MT4VDDT1664A(I)G-335__	128MB	16 Meg x 64	2.7 GB/s	6ns, 333 MT/s	2.5-3-3
MT4VDDT1664A(I)Y-335__	128MB	16 Meg x 64	2.7 GB/s	6ns, 333 MT/s	2.5-3-3
MT4VDDT1664A(I)G-262__	128MB	16 Meg x 64	2.1 GB/s	7.5ns, 266 MT/s	2-2-2
MT4VDDT1664A(I)Y-262__	128MB	16 Meg x 64	2.1 GB/s	7.5ns, 266 MT/s	2-2-2
MT4VDDT1664A(I)G-26A__	128MB	16 Meg x 64	2.1 GB/s	7.5ns, 266 MT/s	2-3-3
MT4VDDT1664A(I)Y-26A__	128MB	16 Meg x 64	2.1 GB/s	7.5ns, 266 MT/s	2-3-3
MT4VDDT1664A(I)G-265__	128MB	16 Meg x 64	2.1GB/s	7.5ns, 266 MT/s	2.5-3-3
MT4VDDT1664A(I)Y-265__	128MB	16 Meg x 64	2.1GB/s	7.5ns, 266 MT/s	2.5-3-3
MT4VDDT3264A(I)G-335__	256MB	32 Meg x 64	2.7 GB/s	6ns, 333 MT/s	2.5-3-3
MT4VDDT3264A(I)Y-335__	256MB	32 Meg x 64	2.7 GB/s	6ns, 333 MT/s	2.5-3-3
MT4VDDT3264A(I)G-262__	256MB	32 Meg x 64	2.1 GB/s	7.5ns, 266 MT/s	2-2-2
MT4VDDT3264A(I)Y-262__	256MB	32 Meg x 64	2.1 GB/s	7.5ns, 266 MT/s	2-2-2
MT4VDDT3264A(I)G-26A__	256MB	32 Meg x 64	2.1 GB/s	7.5ns, 266 MT/s	2-3-3
MT4VDDT3264A(I)Y-26A__	256MB	32 Meg x 64	2.1 GB/s	7.5ns, 266 MT/s	2-3-3
MT4VDDT3264A(I)G-265__	256MB	32 Meg x 64	2.1GB/s	7.5ns, 266 MT/s	2.5-3-3
MT4VDDT3264A(I)Y-265__	256MB	32 Meg x 64	2.1GB/s	7.5ns, 266 MT/s	2.5-3-3

NOTE:

All part numbers end with a two-place code (not shown), designating component and PCB revisions. Consult factory for current revision codes. Example: MT4VDDT1664AG-265A1.

**Table 3: Pin Assignment
(184-Pin DIMM Front)**

PIN	SYMBOL	PIN	SYMBOL	PIN	SYMBOL	PIN	SYMBOL
1	VREF	24	DQ17	47	DNU	70	VDD
2	DQ0	25	DQS2	48	A0	71	NC
3	Vss	26	Vss	49	DNU	72	DQ48
4	DQ1	27	A9	50	Vss	73	DQ49
5	DQS0	28	DQ18	51	DNU	74	Vss
6	DQ2	29	A7	52	BA1	75	CK2#
7	VDD	30	VDDQ	53	DQ32	76	CK2
8	DQ3	31	DQ19	54	VDDQ	77	VDDQ
9	NC	32	A5	55	DQ33	78	DQS6
10	DNU	33	DQ24	56	DQS4	79	DQ50
11	Vss	34	Vss	57	DQ34	80	DQ51
12	DQ8	35	DQ25	58	Vss	81	Vss
13	DQ9	36	DQS3	59	BA0	82	NC
14	DQS1	37	A4	60	DQ35	83	DQ56
15	VDDQ	38	VDD	61	DQ40	84	DQ57
16	CK1	39	DQ26	62	VDDQ	85	VDD
17	CK1#	40	DQ27	63	WE#	86	DQS7
18	Vss	41	A2	64	DQ41	87	DQ58
19	DQ10	42	Vss	65	CAS#	88	DQ59
20	DQ11	43	A1	66	Vss	89	Vss
21	CKE0	44	DNU	67	DQS5	90	NC
22	VDDQ	45	DNU	68	DQ42	91	SDA
23	DQ16	46	VDD	69	DQ43	92	SCL

**Table 4: Pin Assignment
(184-Pin DIMM Back)**

PIN	SYMBOL	PIN	SYMBOL	PIN	SYMBOL	PIN	SYMBOL
93	Vss	116	Vss	139	Vss	162	DQ47
94	DQ4	117	DQ21	140	DNU	163	NC
95	DQ5	118	A11	141	A10	164	VDDQ
96	VDDQ	119	DM2	142	DNU	165	DQ52
97	DM0	120	VDD	143	VDDQ	166	DQ53
98	DQ6	121	DQ22	144	DNU	167	NC
99	DQ7	122	A8	145	Vss	168	VDD
100	Vss	123	DQ23	146	DQ36	169	DM6
101	NC	124	Vss	147	DQ37	170	DQ54
102	NC	125	A6	148	VDD	171	DQ55
103	NC	126	DQ28	149	DM4	172	VDDQ
104	VDDQ	127	DQ29	150	DQ38	173	NC
105	DQ12	128	VDDQ	151	DQ39	174	DQ60
106	DQ13	129	DM3	152	Vss	175	DQ61
107	DM1	130	A3	153	DQ44	176	VSS
108	VDD	131	DQ30	154	RAS#	177	DM7
109	DQ14	132	Vss	155	DQ45	178	DQ62
110	DQ15	133	DQ31	156	VDDQ	179	DQ63
111	DNU	134	DNU	157	S0#	180	VDDQ
112	VDDQ	135	DNU	158	NC	181	SA0
113	NC	136	VDDQ	159	DM5	182	SA1
114	DQ20	137	CK0	160	Vss	183	SA2
115	NC/A12	138	CK0#	161	DQ46	184	VDDSPD

NOTE:

Pin 115 is no connect (NC) for 64MB, or is address input A12 for 128MB, 256MB.

184-Pin DIMM Pinouts

Front View

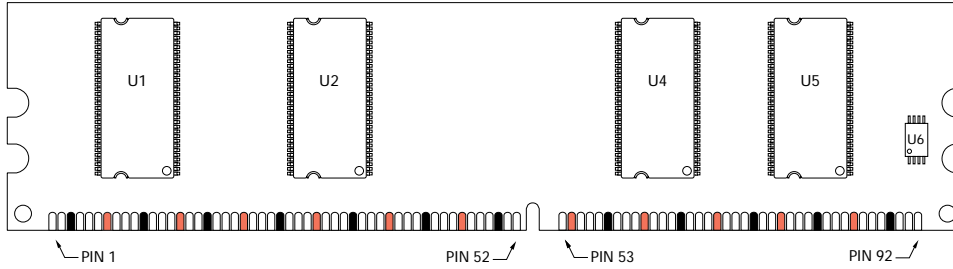

Back View



■ Indicates a VDD or VDDQ pin ■ Indicates a VSS pin

Table 5: Pin Descriptions

Pin numbers may not correlate with symbols; refer to Pin Assignment tables on page 3 for more information

PIN NUMBERS	SYMBOL	TYPE	DESCRIPTION
63, 65, 154	WE#, CAS#, RAS#	Input	Command Inputs: RAS#, CAS#, and WE# (along with S#) define the command being entered.
16, 17, 75, 76, 137, 138	CK0, CK0#, CK1, CK1#, CK2, CK2#	Input	Clock: CK and CK# are differential clock inputs. All address and control input signals are sampled on the crossing of the positive edge of CK and negative edge of CK#. Output data (DQs and DQS) is referenced to the crossings of CK and CK#.
21	CKE	Input	Clock Enable: CKE HIGH activates and CKE LOW deactivates the internal clock, input buffers, and output drivers. Taking CKE LOW provides PRECHARGE POWER-DOWN and SELF REFRESH operations (all device banks idle), or ACTIVE POWER-DOWN (row ACTIVE in any device bank). CKE is synchronous for POWER-DOWN entry and exit, and for SELF REFRESH entry. CKE is asynchronous for SELF REFRESH exit and for disabling the outputs. CKE must be maintained HIGH throughout read and write accesses. Input buffers (excluding CK, CK# and CKE) are disabled during POWER-DOWN. Input buffers (excluding CKE) are disabled during SELF REFRESH. CKE is an SSTL_2 input but will detect an LVCMOS LOW level after VDD is applied and until CKE is first brought HIGH. After CKE is brought HIGH, it becomes an SSTL_2 input only.
157	S0#	Input	Chip Select: S# enables (registered LOW) and disables (registered HIGH) the command decoder. All commands are masked when S# is registered HIGH. S# is considered part of the command code.
52, 59	BA0, BA1	Input	Bank Address: BA0 and BA1 define to which device bank an ACTIVE, READ, WRITE, or PRECHARGE command is being applied.

Table 5: Pin Descriptions

Pin numbers may not correlate with symbols; refer to Pin Assignment tables on page 3 for more information

PIN NUMBERS	SYMBOL	TYPE	DESCRIPTION
27, 29, 32, 37, 41, 43, 48, 115 (128MB, 256MB), 118, 122, 125, 130, 141	A0–A11 (64MB) A0–A12 (128MB, 256MB)	Input	Address Inputs: Provide the row address for ACTIVE commands, and the column address and auto precharge bit (A10) for READ/WRITE commands, to select one location out of the memory array in the respective device bank. A10 sampled during a PRECHARGE command determines whether the PRECHARGE applies to one device bank (A10 LOW, device bank selected by BA0, BA1) or all device banks (A10 HIGH). The address inputs also provide the op-code during a MODE REGISTER SET command. BA0 and BA1 define which mode register (mode register or extended mode register) is loaded during the LOAD MODE REGISTER command.
91	SDA	Input/Output	Serial Presence-Detect Data: SDA is a bidirectional pin used to transfer addresses and data into and out of the presence-detect portion of the module.
92	SCL	Input	Serial Clock for Presence-Detect: SCL is used to synchronize the presence-detect data transfer to and from the module.
181, 182, 183	SA0–SA2	Input	Presence-Detect Address Inputs: These pins are used to configure the presence-detect device.
97, 107, 119, 129, 149, 159, 169, 177	DM0–DM7	Input/Output	Data Write Mask: DM LOW allows WRITE operation. DM HIGH blocks WRITE operation. DM lines do not affect READ operation.
5, 14, 25, 36, 56, 67, 78, 86	DQS0–DQS7	Input/Output	Data Strobe: Output with READ data, input with WRITE data. DQS is edge-aligned with READ data, centered in WRITE data. Used to capture data.
2, 4, 6, 8, 12, 13, 19, 20, 23, 24, 28, 31, 33, 35, 39, 40, 53, 55, 57, 60, 61, 64, 68, 69, 72, 73, 79, 80, 83, 84, 87, 88, 94, 95, 98, 99, 105, 106, 109, 110, 114, 117, 121, 123, 126, 127, 131, 133, 146, 147, 150, 151, 153, 155, 161, 162, 165, 166, 170, 171, 174, 175, 178, 179	DQ0–DQ63	Input/Output	Data I/Os: Data bus.
1	VREF	Supply	SSTL_2 reference voltage.
15, 22, 30, 54, 62, 77, 96, 104, 112, 128, 136, 143, 156, 164, 172, 180	VDDQ	Supply	DQ Power Supply: +2.5V ±0.2V.
7, 38, 46, 70, 85, 108, 120, 148, 168	VDD	Supply	Power Supply: +2.5V ±0.2V.
3, 11, 18, 26, 34, 42, 50, 58, 66, 74, 81, 89, 93, 100, 116, 124, 132, 139, 145, 152, 160, 176	VSS	Supply	Ground.
184	VDDSPD	Supply	Serial EEPROM positive power supply: +2.3V to +3.6V.
9, 71, 82, 90, 101, 102, 103, 113, 115 (64MB), 158, 163, 167, 173	NC	–	No Connect: These pins should be left unconnected.
10, 44, 45, 47, 49, 51, 111, 134, 135, 140, 142, 144	DNU	–	Do Not Use: These pins are not connected on this module but are assigned pins on other modules in this product family.

Figure 2: Functional Block Diagram

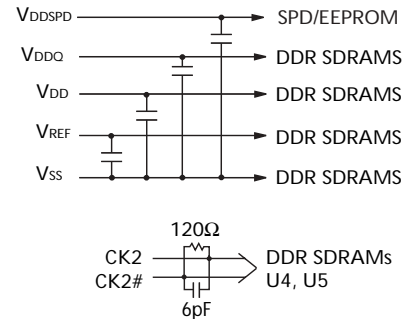
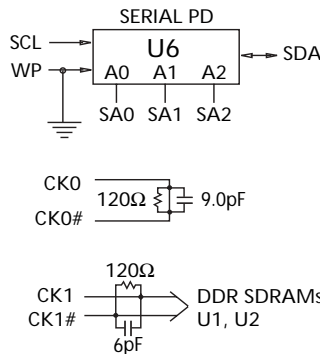
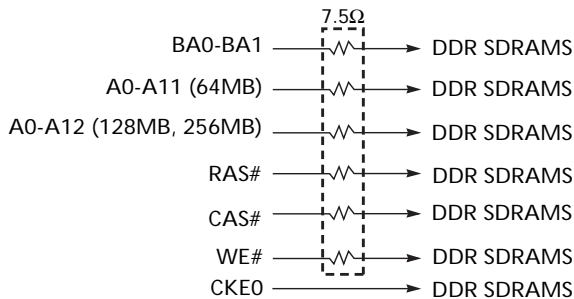
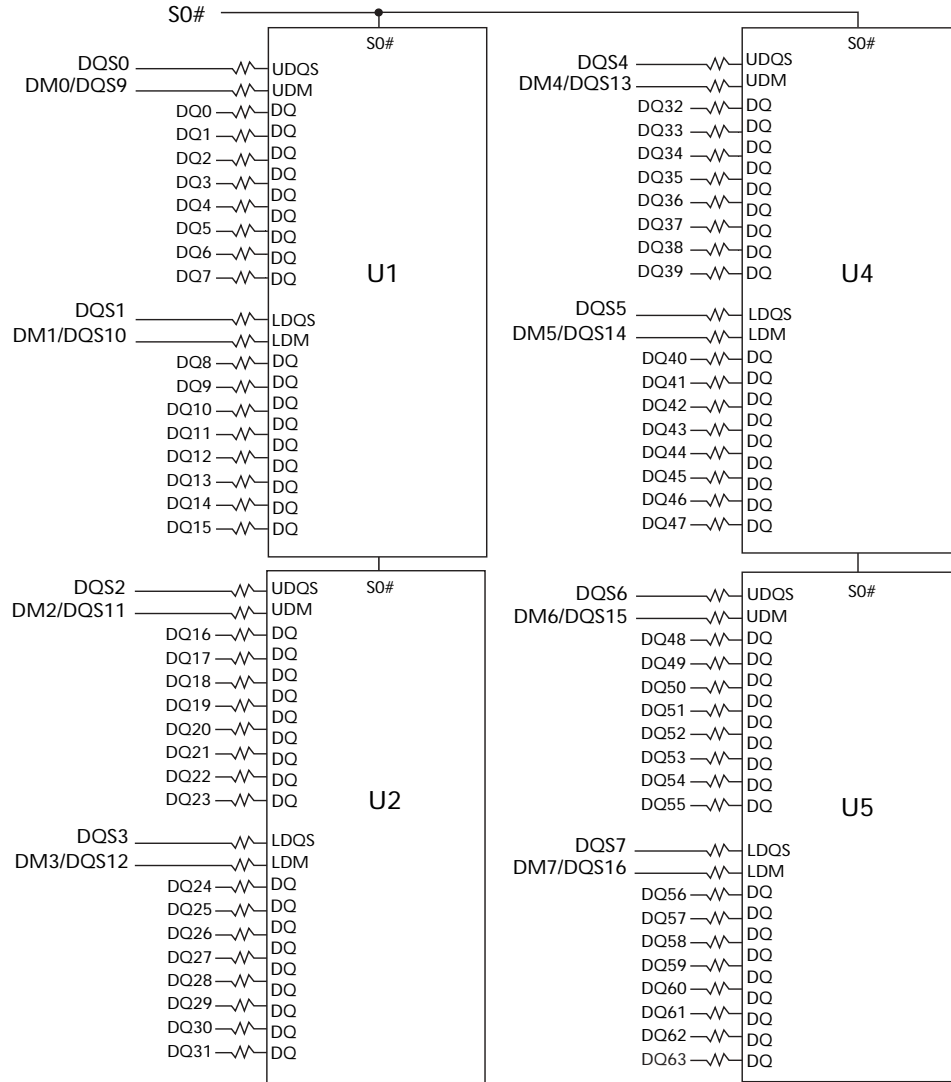

NOTE:

1. Unless otherwise noted, resistor values are 22Ω.
2. DQ wiring may differ from that described in this drawing; however DQ/DM/ DQS relationships are maintained as shown.
3. Per industry standard, Micron modules utilize various component speed grades, as referenced in the module part numbering guide at www.micron.com/numberguide.

Standard modules use the following DDR SDRAM devices:
MT46V8M16TG (64MB); MT46V16M16TG (128MB); MT46V32M16TG (256MB)

Lead-free modules use the following DDR SDRAM devices:
MT46V8M16P (64MB); MT46V16M16P (128MB); MT46V32M16P (256MB)

Contact factory for availability of Ind. Temp. DIMMs.

General Description

The MT4VDDT864A, MT4VDDT1664A, and MT4VDDT3264A are high-speed CMOS, dynamic random-access, 64MB, 128MB, and 256MB memory modules organized in a x64 configuration. DDR SDRAM modules use internally configured quad-bank DDR SDRAM devices.

DDR SDRAM modules use a double data rate architecture to achieve high-speed operation. The double data rate architecture is essentially a $2n$ -prefetch architecture with an interface designed to transfer two data words per clock cycle at the I/O pins. A single read or write access for DDR SDRAM modules effectively consists of a single $2n$ -bit wide, one-clock-cycle data transfer at the internal DRAM core and two corresponding n -bit wide, one-half-clock-cycle data transfers at the I/O pins.

A bidirectional data strobe (DQS) is transmitted externally, along with data, for use in data capture at the receiver. DQS is an intermittent strobe transmitted by the DDR SDRAM during READs and by the memory controller during WRITEs. DQS is edge-aligned with data for READs and center-aligned with data for WRITEs.

DDR SDRAM modules operate from differential clocks (CK, CK#); the crossing of CK going HIGH and CK# going LOW will be referred to as the positive edge of CK. Commands (address and control signals) are registered at every positive edge of CK. Input data is registered on both edges of DQS, and output data is referenced to both edges of DQS, as well as to both edges of CK.

Read and write accesses to DDR SDRAM modules are burst oriented; accesses start at a selected location and continue for a programmed number of locations in a programmed sequence. Accesses begin with the registration of an ACTIVE command, which is then followed by a READ or WRITE command. The address bits registered coincident with the ACTIVE command are used to select the device bank and row to be accessed (BA0, BA1 select device bank, A0–A11 (64MB) or A0–A12 (128MB, 256MB) select device row). The address bits registered coincident with the READ or WRITE command are used to select the device bank and the starting device column location for the burst access.

DDR SDRAM modules provide for programmable read or write burst lengths of 2, 4, or 8 locations. An auto precharge function may be enabled to provide a self-timed row precharge that is initiated at the end of the burst access.

The pipelined, multibank architecture of DDR SDRAM modules allows for concurrent operation,

thereby providing high effective bandwidth by hiding row precharge and activation time.

An auto refresh mode is provided, along with a power-saving power-down mode. All inputs are compatible with the JEDEC Standard for SSTL_2. All outputs are SSTL_2, Class II compatible. For more information regarding DDR SDRAM operation, refer to the 128Mb, 256Mb, or 512Mb DDR SDRAM component data sheets.

Serial Presence-Detect Operation

DDR SDRAM modules incorporate serial presence-detect (SPD). The SPD function is implemented using a 2,048-bit EEPROM. This nonvolatile storage device contains 256 bytes. The first 128 bytes can be programmed by Micron to identify the module type and various SDRAM organizations and timing parameters. The remaining 128 bytes of storage are available for use by the customer. System READ/WRITE operations between the master (system logic) and the slave EEPROM device (DIMM) occur via a standard I²C bus using the DIMM's SCL (clock) and SDA (data) signals, together with SA (2:0), which provide eight unique DIMM/EEPROM addresses. Write protect (WP) is tied to ground on the module, permanently disabling hardware write protect.

Mode Register Definition

The mode register is used to define the specific mode of operation of DDR SDRAM devices. This definition includes the selection of a burst length, a burst type, a CAS latency and an operating mode, as shown in Figure 3, Mode Register Definition Diagram, on page 8. The mode register is programmed via the MODE REGISTER SET command (with BA0 = 0 and BA1 = 0) and will retain the stored information until it is programmed again or the device loses power (except for bit A8, which is self-clearing).

Reprogramming the mode register will not alter the contents of the memory, provided it is performed correctly. The mode register must be loaded (reloaded) when all device banks are idle and no bursts are in progress, and the controller must wait the specified time before initiating the subsequent operation. Violating either of these requirements will result in unspecified operation.

Mode register bits A0–A2 specify the burst length, A3 specifies the type of burst (sequential or interleaved), A4–A6 specify the CAS latency, and A7–A11 (64MB), or A7–A12 (128MB, 256MB) specify the operating mode.

Burst Length

Read and write accesses to DDR SDRAM devices are burst oriented, with the burst length being programmable, as shown in Figure 3, Mode Register Definition Diagram. The burst length determines the maximum number of column locations that can be accessed for a given READ or WRITE command. Burst lengths of 2, 4, or 8 locations are available for both the sequential and the interleaved burst types.

Reserved states should not be used, as unknown operation or incompatibility with future versions may result.

When a READ or WRITE command is issued, a block of columns equal to the burst length is effectively selected. All accesses for that burst take place within this block, meaning that the burst will wrap within the block if a boundary is reached. The block is uniquely selected by A1–Ai when the burst length is set to two, by A2–Ai when the burst length is set to four and by A3–Ai when the burst length is set to eight (where Ai is the most significant column address bit for a given configuration. See Note 5 of Table 6, Burst Definition Table, on page 9, for Ai values). The remaining (least significant) address bit(s) is (are) used to select the starting location within the block. The programmed burst length applies to both read and write bursts.

Burst Type

Accesses within a given burst may be programmed to be either sequential or interleaved; this is referred to as the burst type and is selected via bit M3.

The ordering of accesses within a burst is determined by the burst length, the burst type and the starting column address, as shown in Table 6, Burst Definition Table, on page 9.

Read Latency

The READ latency is the delay, in clock cycles, between the registration of a READ command and the availability of the first bit of output data. The latency can be set to 2 or 2.5 clocks, as shown in Figure 4, CAS Latency Diagram.

If a READ command is registered at clock edge *n*, and the latency is *m* clocks, the data will be available nominally coincident with clock edge *n + m*. Figure 7, CAS Latency (CL) Table, on page 9, indicates the operating frequencies at which each CAS latency setting can be used.

Reserved states should not be used as unknown operation or incompatibility with future versions may result.

Figure 3: Mode Register Definition Diagram

64MB Module

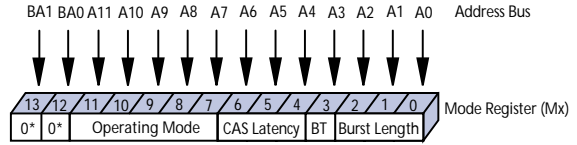

* M13 and M12 (BA1 and BA0) must be "0, 0" to select the base mode register (vs. the extended mode register).

128MB, 256MB Modules

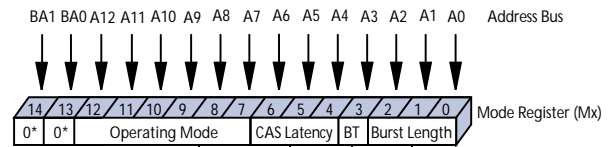

* M14 and M13 (BA1 and BA0) must be "0, 0" to select the base mode register (vs. the extended mode register).

			Burst Length	
			M3 = 0	M3 = 1
M2	M1	M0	Reserved	Reserved
0	0	0	2	2
0	0	1	4	4
0	1	0	8	8
0	1	1	Reserved	Reserved
1	0	0	Reserved	Reserved
1	0	1	Reserved	Reserved
1	1	0	Reserved	Reserved
1	1	1	Reserved	Reserved

M3	Burst Type
0	Sequential
1	Interleaved

M6	M5	M4	CAS Latency
0	0	0	Reserved
0	0	1	Reserved
0	1	0	2
0	1	1	Reserved
1	0	0	Reserved
1	0	1	Reserved
1	1	0	2.5
1	1	1	Reserved

M12	M11	M10	M9	M8	M7	M6-M0	Operating Mode
0	0	0	0	0	0	Valid	Normal Operation
0	0	0	0	1	0	Valid	Normal Operation/Reset DLL
-	-	-	-	-	-	-	All other states reserved

Table 6: Burst Definition Table

BURST LENGTH	STARTING COLUMN ADDRESS		ORDER OF ACCESSES WITHIN A BURST		
			TYPE = SEQUENTIAL	TYPE = INTERLEAVED	
2	A0				
	0		0-1	0-1	
	1		1-0	1-0	
4	A1 A0				
	0	0	0-1-2-3	0-1-2-3	
	0	1	1-2-3-0	1-0-3-2	
	1	0	2-3-0-1	2-3-0-1	
	1	1	3-0-1-2	3-2-1-0	
8	A2 A1 A0				
	0	0	0	0-1-2-3-4-5-6-7	0-1-2-3-4-5-6-7
	0	0	1	1-2-3-4-5-6-7-0	1-0-3-2-5-4-7-6
	0	1	0	2-3-4-5-6-7-0-1	2-3-0-1-6-7-4-5
	0	1	1	3-4-5-6-7-0-1-2	3-2-1-0-7-6-5-4
	1	0	0	4-5-6-7-0-1-2-3	4-5-6-7-0-1-2-3
	1	0	1	5-6-7-0-1-2-3-4	5-4-7-6-1-0-3-2
	1	1	0	6-7-0-1-2-3-4-5	6-7-4-5-2-3-0-1
	1	1	1	7-0-1-2-3-4-5-6	7-6-5-4-3-2-1-0

NOTE:

- For a burst length of two, A1–Ai select the two-data-element block; A0 selects the first access within the block.
- For a burst length of four, A2–Ai select the four-data-element block; A0–A1 select the first access within the block.
- For a burst length of eight, A3–Ai select the eight-data-element block; A0–A2 select the first access within the block.
- Whenever a boundary of the block is reached within a given sequence above, the following access wraps within the block.
- Ai = A8 (64MB, 128MB)
Ai = A9 (256MB).

Table 7: CAS Latency (CL) Table

SPEED	ALLOWABLE OPERATING CLOCK FREQUENCY (MHZ)	
	CL = 2	CL = 2.5
-335	75 ≤ f ≤ 133	75 ≤ f ≤ 167
-262	75 ≤ f ≤ 133	75 ≤ f ≤ 133
-26A	75 ≤ f ≤ 133	75 ≤ f ≤ 133
-265	75 ≤ f ≤ 100	75 ≤ f ≤ 133

Figure 4: CAS Latency Diagram

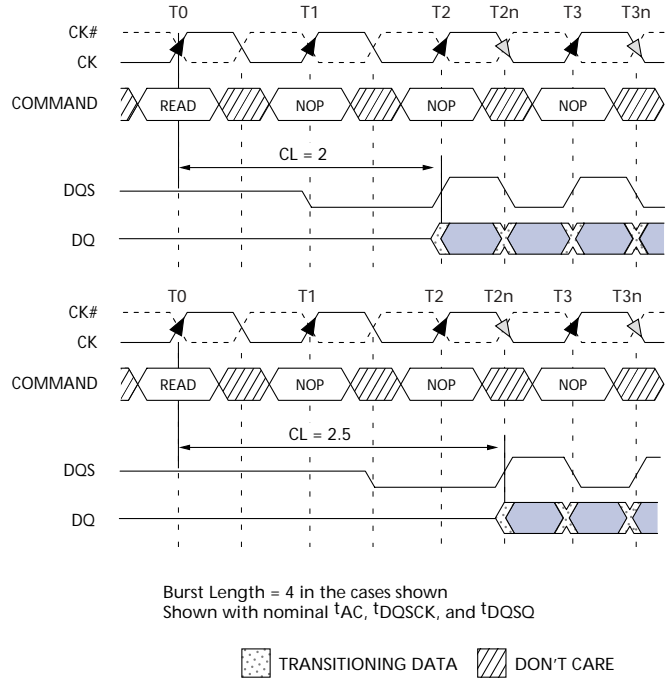

Operating Mode

The normal operating mode is selected by issuing a MODE REGISTER SET command with bits A7–A11 (64MB) or A7–A12 (128MB, 256MB) each set to zero, and bits A0–A6 set to the desired values. A DLL reset is initiated by issuing a MODE REGISTER SET command with bits A7 and A9–A11 (64MB) or A9–A12 (128MB, 256MB) each set to zero, bit A8 set to one, and bits A0–A6 set to the desired values. Although not required by the Micron device, JEDEC specifications recommend when a LOAD MODE REGISTER command is issued to reset the DLL, it should always be followed by a LOAD MODE REGISTER command to select normal operating mode.

All other combinations of values for A7–A11 (64MB) or A7–A12 (128MB, 256MB) are reserved for future use and/or test modes. Test modes and reserved states should not be used because unknown operation or incompatibility with future versions may result.

Extended Mode Register

The extended mode register controls functions beyond those controlled by the mode register; these additional functions are DLL enable/disable and output drive strength. These functions are controlled via the bits shown in Figure 5, Extended Mode Register Definition Diagram, on page 10. The extended mode register is programmed via the LOAD MODE REGIS-

TER command to the mode register (with BA0 = 1 and BA1 = 0) and will retain the stored information until it is programmed again or the device loses power. The enabling of the DLL should always be followed by a LOAD MODE REGISTER command to the mode register (BA0/BA1 both low) to reset the DLL.

The extended mode register must be loaded when all device banks are idle and no bursts are in progress, and the controller must wait the specified time before initiating any subsequent operation. Violating either of these requirements could result in unspecified operation.

Output Drive Strength

The normal full drive strength for all outputs is specified to be SSTL2, Class II. The x16 supports an option for reduced drive. This option is intended for the support of the lighter load and/or point-to-point environments. The selection of the reduced drive strength will alter the DQs and DQSs from SSTL2, Class II drive strength to a reduced drive strength, which is approximately 54 percent of the SSTL2, Class II drive strength.

For detailed information on programmable and reduced drive strength option, refer to the 128Mb, 256Mb, or 512Mb DDR SDRAM component data sheets.

DLL Enable/Disable

The DLL must be enabled for normal operation. DLL enable is required during power-up initialization and upon returning to normal operation after having disabled the DLL for the purpose of debug or evaluation. (When the device exits self refresh mode, the DLL is enabled automatically.) Any time the DLL is enabled, 200 clock cycles must occur before a READ command can be issued.

Figure 5: Extended Mode Register Definition Diagram

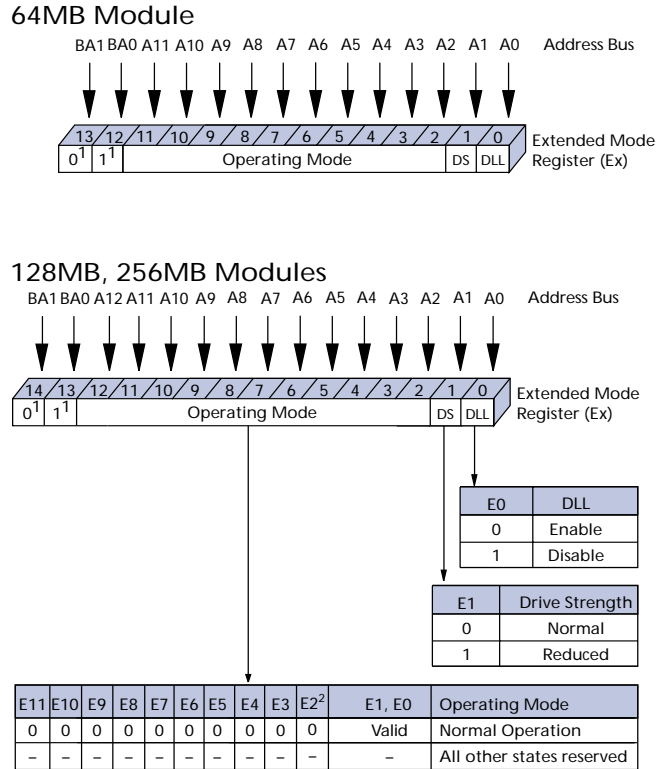

NOTE:

1. BA1 and BA0 (E13 and E12 for 64MB, E14 and E13 for 128MB or 256MB) must be "0, 1" to select the Extended Mode Register (vs. the base Mode Register).
2. The QFC# option is not supported.

Commands

Table 8, Commands Truth Table, and Table 9, DM Operation Truth Table, provide a general reference of available commands. For a more detailed description

of commands and operations, refer to the 128Mb, 256Mb, or 512Mb DDR SDRAM component data sheet.

Table 8: Commands Truth Table

CKE is HIGH for all commands shown except SELF REFRESH; all states and sequences not shown are illegal or reserved

NAME (FUNCTION)	CS#	RAS#	CAS#	WE#	ADDR	NOTES
DESELECT (NOP)	H	X	X	X	X	1
NO OPERATION (NOP)	L	H	H	H	X	1
ACTIVE (Select bank and activate row)	L	L	H	H	Bank/Row	2
READ (Select bank and column, and start READ burst)	L	H	L	H	Bank/Col	3
WRITE (Select bank and column, and start WRITE burst)	L	H	L	L	Bank/Col	3
BURST TERMINATE	L	H	H	L	X	4
PRECHARGE (Deactivate row in bank or banks)	L	L	H	L	Code	5
AUTO REFRESH or SELF REFRESH (Enter self refresh mode)	L	L	L	H	X	6, 7
LOAD MODE REGISTER	L	L	L	L	Op-Code	8

NOTE:

1. Deselect and NOP are functionally interchangeable.
2. BA0–BA1 provide device bank address and A0–A11 (64MB) or A0–A12 (128MB, 256MB) provide row address.
3. BA0–BA1 provide device bank address; A0–A9 (64MB, 128MB) or A0–A9, A11 (256MB) provide column address; A10 HIGH enables the auto precharge feature (nonpersistent), and A10 LOW disables the auto precharge feature.
4. Applies only to read bursts with auto precharge disabled; this command is undefined (and should not be used) for READ bursts with auto precharge enabled and for WRITE bursts.
5. A10 LOW: BA0–BA1 determine which device bank is precharged. A10 HIGH: all device banks are precharged and BA0–BA1 are "Don't Care."
6. This command is AUTO REFRESH if CKE is HIGH, SELF REFRESH if CKE is LOW.
7. Internal refresh counter controls row addressing; all inputs and I/Os are "Don't Care" except for CKE.
8. BA0–BA1 select either the mode register or the extended mode register (BA0 = 0, BA1 = 0 select the mode register; BA0 = 1, BA1 = 0 select extended mode register; other combinations of BA0–BA1 are reserved). A0–A11 (64MB) or A0–A12 (128MB, 256MB) provide the op-code to be written to the selected mode register.

Table 9: DM Operation Truth Table

Used to mask write data; provided coincident with the corresponding data

NAME (FUNCTION)	DM	DQS
WRITE Enable	L	Valid
WRITE Inhibit	H	X



Absolute Maximum Ratings

Stresses greater than those listed may cause permanent damage to the device. This is a stress rating only, and functional operation of the device at these or any other conditions above those indicated in the opera-

tional sections of this specification is not implied. Exposure to absolute maximum rating conditions for extended periods may affect reliability.

VDD Supply Voltage Relative to VSS -1V to +3.6V
 VDDQ Supply Voltage Rel. to VSS -1V to +3.6V
 VREF and Inputs Voltage
 Relative to VSS -1V to +3.6V
 I/O Pins Voltage
 Relative to VSS. -0.5V to VDDQ +0.5V

Operating Temperature,
 T_A (ambient - commercial) 0°C to +70°C
 T_A (ambient - industrial) -40°C to +85°C
 Storage Temperature (plastic) -55°C to +150°C
 Short Circuit Output Current. 50mA

Table 10: DC Electrical Characteristics and Operating Conditions

Notes: 1-5, 14, 48; notes appear on pages 18-21; 0°C ≤ T_A ≤ +70°C

PARAMETER/CONDITION		SYMBOL	MIN	MAX	UNITS	NOTES
Supply Voltage		VDD	2.3	2.7	V	32, 37
I/O Supply Voltage		VDDQ	2.3	2.7	V	32, 37, 40
I/O Reference Voltage		VREF	0.49 x VDDQ	0.51 x VDDQ	V	6, 40
I/O Termination Voltage (system)		VTT	VREF - 0.04	VREF + 0.04	V	7, 40
Input High (Logic 1) Voltage		V _{IH} (DC)	VREF + 0.15	VDD + 0.3	V	25
Input Low (Logic 0) Voltage		V _{IL} (DC)	-0.3	VREF - 0.15	V	25
INPUT LEAKAGE CURRENT Any input, 0V ≤ V _{IN} ≤ VDD, VREF pin 0V ≤ V _{IN} ≤ 1.35V (All other pins not under test = 0V)	Command/ Address, S#, CKE	I _I	-8	8	μA	47
	CK, CK#	I _I	-4	4	μA	47
	DM	I _I	-2	2	μA	47
OUTPUT LEAKAGE CURRENT (DQ pins are disabled; 0V ≤ V _{OUT} ≤ VDDQ)	DQ, DQS	I _{OZ}	-5	5	μA	47
OUTPUT LEVELS: Full drive option						
High Current (V _{OUT} = VDDQ - 0.373V, minimum VREF, minimum VTT)		I _{OH}	-16.8	-	mA	33, 35
Low Current (V _{OUT} = 0.373V, maximum VREF, maximum VTT)		I _{OL}	16.8	-	mA	
OUTPUT LEVELS: Reduced drive option						
High Current (V _{OUT} = VDDQ - 0.763V, minimum VREF, minimum VTT)		I _{OHR}	-9	-	mA	34, 35
Low Current (V _{OUT} = 0.763V, maximum VREF, maximum VTT)		I _{OLR}	9	-	mA	

Table 11: AC Input Operating Conditions

Notes: 1-5, 14, 49; notes appear on pages 18-21; 0°C ≤ T_A ≤ +70°C; VDD = VDDQ = +2.5V ±0.2V

PARAMETER/CONDITION	SYMBOL	MIN	MAX	UNITS	NOTES
Input High (Logic 1) Voltage	V _{IH} (AC)	VREF + 0.310	-	V	12, 25, 36
Input Low (Logic 0) Voltage	V _{IL} (AC)	-	VREF - 0.310	V	12, 25, 36
I/O Reference Voltage	VREF(AC)	0.49 x VDDQ	0.51 x VDDQ	V	6



Table 12: IDD Specifications and Conditions – 64MB

DDR SDRAM components only

Notes: 1–5, 8, 10, 12, 48; notes appear on pages 18–21; $0^{\circ}\text{C} \leq T_A \leq +70^{\circ}\text{C}$; $V_{DD} = V_{DDQ} = +2.5\text{V} \pm 0.2\text{V}$

PARAMETER/CONDITION	SYM	MAX			UNITS	NOTES
		-335	-262	-26A/ -265		
OPERATING CURRENT: One device bank; Active-Precharge; $t_{RC} = t_{RC}(\text{MIN})$; $t_{CK} = t_{CK}(\text{MIN})$; DQ, DM, and DQS inputs changing once per clock cycle; Address and control inputs changing once every two clock cycles.	IDD0	500	440	440	mA	20, 42
OPERATING CURRENT: One device bank; Active-Read-Precharge; Burst = 2; $t_{RC} = t_{RC}(\text{MIN})$; $t_{CK} = t_{CK}(\text{MIN})$; $I_{OUT} = 0\text{mA}$; Address and control inputs changing once per clock cycle.	IDD1	540	540	500	mA	20, 42
PRECHARGE POWER-DOWN STANDBY CURRENT: All device banks idle; Power-down mode; $t_{CK} = t_{CK}(\text{MIN})$; CKE = LOW.	IDD2P	12	12	12	mA	21, 28, 44
IDLE STANDBY CURRENT: CS# = HIGH; All device banks idle; $t_{CK} = t_{CK}(\text{MIN})$; CKE = HIGH; Address and other control inputs changing once per clock cycle. $V_{IN} = V_{REF}$ for DQ, DQS, and DM.	IDD2F	180	180	160	mA	45
ACTIVE POWER-DOWN STANDBY CURRENT: One device bank active; Power-down mode; $t_{CK} = t_{CK}(\text{MIN})$; CKE = LOW.	IDD3P	100	100	80	mA	21, 28, 44
ACTIVE STANDBY CURRENT: CS# = HIGH; CKE = HIGH; One device bank; Active-Precharge; $t_{RC} = t_{RAS}(\text{MAX})$; $t_{CK} = t_{CK}(\text{MIN})$; DQ, DM, and DQS inputs changing twice per clock cycle; Address and other control inputs changing once per clock cycle.	IDD3N	200	200	180	mA	20
OPERATING CURRENT: Burst = 2; Reads; Continuous burst; One device bank active; Address and control inputs changing once per clock cycle; $t_{CK} = t_{CK}(\text{MIN})$; $I_{OUT} = 0\text{mA}$.	IDD4R	580	560	540	mA	20, 42
OPERATING CURRENT: Burst = 2; Writes; Continuous burst; One device bank active; Address and control inputs changing once per clock cycle; $t_{CK} = t_{CK}(\text{MIN})$; DQ, DM, and DQS inputs changing twice per clock cycle.	IDD4W	620	520	520	mA	20
AUTO REFRESH CURRENT	$t_{REFC} = t_{RFC}(\text{MIN})$	1,060	1,000	1,000	mA	44
	$t_{REFC} = 15.625\mu\text{s}$	20	20	20	mA	24, 44
SELF REFRESH CURRENT: CKE $\leq 0.2\text{V}$	IDD6	12	12	8	mA	9
OPERATING CURRENT: Four device bank interleaving READs (BL = 4) with auto precharge, $t_{RC} = t_{RC}(\text{MIN})$; $t_{CK} = t_{CK}(\text{MIN})$; Address and control inputs change only during Active, READ, or WRITE commands.	IDD7	1,540	1,500	1,500	mA	20, 43

Table 13: IDD Specifications and Conditions – 128MB

DDR SDRAM components only

 Notes: 1–5, 8, 10, 12, 48; notes appear on pages 18–21; $0^{\circ}\text{C} \leq T_A \leq +70^{\circ}\text{C}$; $V_{DD} = V_{DDQ} = +2.5\text{V} \pm 0.2\text{V}$

PARAMETER/CONDITION	SYM	MAX			UNITS	NOTES	
		-335	-262	-26A/ -265			
OPERATING CURRENT: One device bank; Active-Precharge; $t_{RC} = t_{RC}(\text{MIN})$; $t_{CK} = t_{CK}(\text{MIN})$; DQ, DM, and DQS inputs changing once per clock cycle; Address and control inputs changing once every two clock cycles.	IDD0	500	500	480	mA	20, 42	
OPERATING CURRENT: One device bank; Active-Read-Precharge; Burst = 4; $t_{RC} = t_{RC}(\text{MIN})$; $t_{CK} = t_{CK}(\text{MIN})$; $I_{OUT} = 0\text{mA}$; Address and control inputs changing once per clock cycle.	IDD1	680	640	580	mA	20, 42	
PRECHARGE POWER-DOWN STANDBY CURRENT: All device banks idle; Power-down mode; $t_{CK} = t_{CK}(\text{MIN})$; CKE = LOW.	IDD2P	16	16	16	mA	21, 28, 44	
IDLE STANDBY CURRENT: CS# = HIGH; All device banks idle; $t_{CK} = t_{CK}(\text{MIN})$; CKE = HIGH; Address and other control inputs changing once per clock cycle. $V_{IN} = V_{REF}$ for DQ, DQS, and DM.	IDD2F	200	180	180	mA	45	
ACTIVE POWER-DOWN STANDBY CURRENT: One device bank active; Power-down mode; $t_{CK} = t_{CK}(\text{MIN})$; CKE = LOW.	IDD3P	120	100	100	mA	21, 28, 44	
ACTIVE STANDBY CURRENT: CS# = HIGH; CKE = HIGH; One device bank; Active-Precharge; $t_{RC} = t_{RAS}(\text{MAX})$; $t_{CK} = t_{CK}(\text{MIN})$; DQ, DM, and DQS inputs changing twice per clock cycle; Address and other control inputs changing once per clock cycle.	IDD3N	240	200	200	mA	20	
OPERATING CURRENT: Burst = 2; Reads; Continuous burst; One device bank active; Address and control inputs changing once per clock cycle; $t_{CK} = t_{CK}(\text{MIN})$; $I_{OUT} = 0\text{mA}$.	IDD4R	700	600	600	mA	20, 42	
OPERATING CURRENT: Burst = 2; Writes; Continuous burst; One device bank active; Address and control inputs changing once per clock cycle; $t_{CK} = t_{CK}(\text{MIN})$; DQ, DM, and DQS inputs changing twice per clock cycle.	IDD4W	780	640	640	mA	20	
AUTO REFRESH CURRENT	$t_{REFC} = t_{RFC}(\text{MIN})$	IDD5	1,020	940	940	mA	44
	$t_{REFC} = 7.8125\mu\text{s}$	IDD5A	24	24	24	mA	24, 44
SELF REFRESH CURRENT: CKE $\leq 0.2\text{V}$	IDD6	16	16	16	mA	9	
OPERATING CURRENT: Four device bank interleaving READs (BL = 4) with auto precharge, $t_{RC} = t_{RC}(\text{MIN})$; $t_{CK} = t_{CK}(\text{MIN})$; Address and control inputs change only during Active, READ, or WRITE commands.	IDD7	1,760	1,520	1,520	mA	20, 43	

Table 14: IDD Specifications and Conditions – 256MB

DDR SDRAM components only

 Notes: 1–5, 8, 10, 12, 48; notes appear on pages 18–21; $0^{\circ}\text{C} \leq T_A \leq +70^{\circ}\text{C}$; $V_{DD} = V_{DDQ} = +2.5\text{V} \pm 0.2\text{V}$

PARAMETER/CONDITION	SYM	MAX			UNITS	NOTES
		-335	-262	-26A/ -265		
OPERATING CURRENT: One device bank; Active-Precharge; $t_{RC} = t_{RC}(\text{MIN})$; $t_{CK} = t_{CK}(\text{MIN})$; DQ, DM, and DQS inputs changing once per clock cycle; Address and control inputs changing once every two clock cycles.	IDD0	520	520	460	mA	20, 42
OPERATING CURRENT: One device bank; Active-Read-Precharge; Burst = 4; $t_{RC} = t_{RC}(\text{MIN})$; $t_{CK} = t_{CK}(\text{MIN})$; $I_{OUT} = 0\text{mA}$; Address and control inputs changing once per clock cycle.	IDD1	640	640	580	mA	20, 42
PRECHARGE POWER-DOWN STANDBY CURRENT: All device banks idle; Power-down mode; $t_{CK} = t_{CK}(\text{MIN})$; CKE = LOW.	IDD2P	20	20	20	mA	21, 28, 44
IDLE STANDBY CURRENT: CS# = HIGH; All device banks idle; $t_{CK} = t_{CK}(\text{MIN})$; CKE = HIGH; Address and other control inputs changing once per clock cycle. $V_{IN} = V_{REF}$ for DQ, DQS, and DM.	IDD2F	180	180	160	mA	45
ACTIVE POWER-DOWN STANDBY CURRENT: One device bank active; Power-down mode; $t_{CK} = t_{CK}(\text{MIN})$; CKE = LOW.	IDD3P	140	140	120	mA	21, 28, 44
ACTIVE STANDBY CURRENT: CS# = HIGH; CKE = HIGH; One device bank; Active-Precharge; $t_{RC} = t_{RAS}(\text{MAX})$; $t_{CK} = t_{CK}(\text{MIN})$; DQ, DM, and DQS inputs changing twice per clock cycle; Address and other control inputs changing once per clock cycle.	IDD3N	200	200	180	mA	20
OPERATING CURRENT: Burst = 2; Reads; Continuous burst; One device bank active; Address and control inputs changing once per clock cycle; $t_{CK} = t_{CK}(\text{MIN})$; $I_{OUT} = 0\text{mA}$.	IDD4R	660	660	580	mA	20, 42
OPERATING CURRENT: Burst = 2; Writes; Continuous burst; One device bank active; Address and control inputs changing once per clock cycle; $t_{CK} = t_{CK}(\text{MIN})$; DQ, DM, and DQS inputs changing twice per clock cycle.	IDD4W	780	640	540	mA	20
AUTO REFRESH CURRENT	$t_{REFC} = t_{RFC}(\text{MIN})$	1,160	1,160	1,120	mA	44
	$t_{REFC} = 7.8125\mu\text{s}$	40	40	40	mA	24, 44
SELF REFRESH CURRENT: CKE $\leq 0.2\text{V}$	IDD6	20	20	20	mA	9
OPERATING CURRENT: Four device bank interleaving READs (BL = 4) with auto precharge, $t_{RC} = t_{RC}(\text{MIN})$; $t_{CK} = t_{CK}(\text{MIN})$; Address and control inputs change only during Active, READ, or WRITE commands.	IDD7	1,620	1,600	1,400	mA	20, 43

Table 15: Capacitance

Note: 11; notes appear on pages 18–21

PARAMETER	SYMBOL	MIN	MAX	UNITS
Input/Output Capacitance: DQ, DQS/DM	C _{IO}	4.0	5.0	pF
Input Capacitance: Command and Address: S#, CKE	C _{I1}	8.0	12.0	pF
Input Capacitance: CK0, CK0#	C _{I2}	–	9.0	pF
Input Capacitance: CK1, CK1#; CK2, CK2#	C _{I2}	10.0	12.0	pF

Table 16: DDR SDRAM Component Electrical Characteristics and Recommended AC Operating Conditions

 Notes: 1–5, 13-15, 29, 48; notes appear on pages 18–21; 0°C to +70°C; V_{DD} = V_{DDQ} = +2.5V ±0.2V

AC CHARACTERISTICS		-335		-262		-26A/-265		UNITS	NOTES	
PARAMETER	SYMBOL	MIN	MAX	MIN	MAX	MIN	MAX			
Access window of DQs from CK/CK#	t _{AC}	-0.7	+0.7	-0.75	+0.75	-0.75	+0.75	ns		
CK high-level width	t _{CH}	0.45	0.55	0.45	0.55	0.45	0.55	t _{CK}	26	
CK low-level width	t _{CL}	0.45	0.55	0.45	0.55	0.45	0.55	t _{CK}	26	
Clock cycle time	CL = 2.5	t _{CK (2.5)}	6	13	7.5	13	7.5	13	ns	41, 46
	CL = 2	t _{CK (2)}	7.5	13	7.5/10	13	7.5/10	13	ns	41, 46
DQ and DM input hold time relative to DQS	t _{DH}	0.45		0.5		0.5		ns	23, 27	
DQ and DM input setup time relative to DQS	t _{DS}	0.45		0.5		0.5		ns	23, 27	
DQ and DM input pulse width (for each input)	t _{DIPW}	1.75		1.75		1.75		ns	27	
Access window of DQS from CK/CK#	t _{DQSCK}	-0.60	+0.60	-0.75	+0.75	-0.75	+0.75	ns		
DQS input high pulse width	t _{DQSH}	0.35		0.35		0.35		t _{CK}		
DQS input low pulse width	t _{DQSL}	0.35		0.35		0.35		t _{CK}		
DQS-DQ skew, DQS to last DQ valid, per group, per access	t _{DQSQ}		0.45		0.5		0.5	ns	22, 23	
Write command to first DQS latching transition	t _{DQSS}	0.75	1.25	0.75	1.25	0.75	1.25	t _{CK}		
DQS falling edge to CK rising - setup time	t _{DSS}	0.2		0.2		0.2		t _{CK}		
DQS falling edge from CK rising - hold time	t _{DSH}	0.2		0.2		0.2		t _{CK}		
Half clock period	t _{HP}	t _{CH} , t _{CL}		t _{CH} , t _{CL}		t _{CH} , t _{CL}		ns	31	
Data-out high-impedance window from CK/CK#	t _{HZ}		+0.70		+0.75		+0.75	ns	16, 37	
Data-out low-impedance window from CK/CK#	t _{LZ}	-0.70		-0.75		-0.75		ns	16, 37	
Address and control input hold time (fast slew rate)	t _{IHF}	0.75		0.90		.90		ns	12	
Address and control input setup time (fast slew rate)	t _{ISF}	0.75		0.90		.90		ns	12	
Address and control input hold time (slow slew rate)	t _{IHS}	0.80		1		1		ns	12	
Address and control input setup time (slow slew rate)	t _{ISs}	0.80		1		1		ns	12	
Address and Control input pulse width (for each input)	t _{IPW}	2.2		2.2		2.2		ns		



Table 16: DDR SDRAM Component Electrical Characteristics and Recommended AC Operating Conditions (Continued)

Notes: 1-5, 13-15, 29, 48; notes appear on pages 18-21; 0°C to +70°C; VDD = VDDQ = +2.5V ±0.2V

AC CHARACTERISTICS		-335		-262		-26A/-265		UNITS	NOTES	
PARAMETER	SYMBOL	MIN	MAX	MIN	MAX	MIN	MAX			
LOAD MODE REGISTER command cycle time	t _{MRD}	12		15		15		ns		
DQ-DQS hold, DQS to first DQ to go non-valid, per access	t _{QH}	t _{HP} - t _{QHS}		t _{HP} - t _{QHS}		t _{HP} - t _{QHS}		ns	22, 23	
Data hold skew factor	t _{QHS}		0.55		0.75		0.75	ns		
ACTIVE to PRECHARGE command	t _{RAS}	42	70,000	40	120,000	40	120,000	ns	31, 49	
ACTIVE to READ with Auto precharge command	t _{RAP}	15		15		20		ns		
ACTIVE to ACTIVE/AUTO REFRESH command period	t _{RC}	60		60		65		ns		
AUTO REFRESH command period	t _{RFC}	72		75		75		ns	44	
ACTIVE to READ or WRITE delay	t _{RCD}	15		15		20		ns		
PRECHARGE command period	t _{RP}	15		15		20		ns		
DQS read preamble	t _{RPRE}	0.9	1.1	0.9	1.1	0.9	1.1	t _{CK}	38	
DQS read postamble	t _{RPST}	0.4	0.6	0.4	0.6	0.4	0.6	t _{CK}	38	
ACTIVE bank a to ACTIVE bank b command	t _{R RD}	12		15		15		ns		
DQS write preamble	t _{WPRE}	0.25		0.25		0.25		t _{CK}		
DQS write preamble setup time	t _{WPRES}	0		0		0		ns	18, 19	
DQS write postamble	t _{WPST}	0.4	0.6	0.4	0.6	0.4	0.6	t _{CK}	17	
Write recovery time	t _{WR}	15		15		15		ns		
Internal WRITE to READ command delay	t _{WTR}	1		1		1		t _{CK}		
Data valid output window	na	t _{QH} - t _{DQSQ}		t _{QH} - t _{DQSQ}		t _{QH} - t _{DQSQ}		ns	22	
REFRESH to REFRESH command interval	64MB	t _{REFC}		140.6		140.6		140.6	μs	21
	128MB, 256MB			70.3		70.3		70.3	μs	21
Average periodic refresh interval	64MB	t _{REFI}		15.6		15.6		15.6	μs	21
	128MB, 256MB			7.8		7.8		7.8	μs	21
Terminating voltage delay to VDD	t _{VTD}	0		0		0		ns		
Exit SELF REFRESH to non-READ command	t _{XSNR}	75		75		75		ns		
Exit SELF REFRESH to READ command	t _{XSRD}	200		200		200		t _{CK}		

Notes

1. All voltages referenced to VSS.
2. Tests for AC timing, I_{DD} , and electrical AC and DC characteristics may be conducted at nominal reference/supply voltage levels, but the related specifications and device operation are guaranteed for the full voltage range specified.
3. Outputs measured with equivalent load:

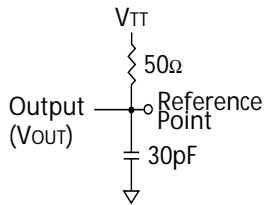

4. AC timing and I_{DD} tests may use a V_{IL} -to- V_{IH} swing of up to 1.5V in the test environment, but input timing is still referenced to V_{REF} (or to the crossing point for CK/CK#), and parameter specifications are guaranteed for the specified AC input levels under normal use conditions. The minimum slew rate for the input signals used to test the device is 1V/ns in the range between $V_{IL}(AC)$ and $V_{IH}(AC)$.
5. The AC and DC input level specifications are as defined in the SSTL_2 Standard (i.e., the receiver will effectively switch as a result of the signal crossing the AC input level, and will remain in that state as long as the signal does not ring back above [below] the DC input LOW [HIGH] level).
6. V_{REF} is expected to equal $V_{DDQ}/2$ of the transmitting device and to track variations in the DC level of the same. Peak-to-peak noise (non-common mode) on V_{REF} may not exceed ± 2 percent of the DC value. Thus, from $V_{DDQ}/2$, V_{REF} is allowed $\pm 25mV$ for DC error and an additional $\pm 25mV$ for AC noise. This measurement is to be taken at the nearest V_{REF} bypass capacitor.
7. V_{TT} is not applied directly to the device. V_{TT} is a system supply for signal termination resistors, is expected to be set equal to V_{REF} and must track variations in the DC level of V_{REF} .
8. I_{DD} is dependent on output loading and cycle rates. Specified values are obtained with minimum cycle time at $CL = 2$ for -262, and -26A, $CL = 2.5$ for -335 and -265 with the outputs open.
9. Enables on-chip refresh and address counters.
10. I_{DD} specifications are tested after the device is properly initialized, and is averaged at the defined cycle rate.
11. This parameter is sampled. $V_{DD} = +2.5V \pm 0.2V$, $V_{DDQ} = +2.5V \pm 0.2V$, $V_{REF} = V_{SS}$, $f = 100$ MHz, $T_A = 25^\circ C$, $V_{OUT}(DC) = V_{DDQ}/2$, V_{OUT} (peak to peak) = 0.2V. DM input is grouped with I/O pins, reflecting the fact that they are matched in loading.
12. For slew rates less than 1 V/ns and greater than or equal to 0.5 V/ns. If slew rate is less than 0.5 V/ns, timing must be derated: t_{IS} has an additional 50ps per each 100mV/ns reduction in slew rate from 500mV/ns, while t_{IH} is unaffected. If slew rate exceeds 4.5V/ns, functionality is uncertain.
13. The CK/CK# input reference level (for timing referenced to CK/CK#) is the point at which CK and CK# cross; the input reference level for signals other than CK/CK# is V_{REF} .
14. Inputs are not recognized as valid until V_{REF} stabilizes. Exception: during the period before V_{REF} stabilizes, $CKE \leq 0.3 \times V_{DDQ}$ is recognized as LOW.
15. The output timing reference level, as measured at the timing reference point indicated in Note 3, is V_{TT} .
16. t_{HZ} and t_{LZ} transitions occur in the same access time windows as valid data transitions. These parameters are not referenced to a specific voltage level, but specify when the device output is no longer driving (HZ) or begins driving (LZ).
17. The intent of the Don't Care state after completion of the postamble is the DQS-driven signal should either be high, low, or high-Z and that any signal transition within the input switching region must follow valid input requirements. That is, if DQS transitions high [above $V_{IHDC}(MIN)$] then it must not transition low (below V_{IHDC}) prior to $t_{DQSH}(MIN)$.
18. This is not a device limit. The device will operate with a negative value, but system performance could be degraded due to bus turnaround.
19. It is recommended that DQS be valid (HIGH or LOW) on or before the WRITE command. The case shown (DQS going from High-Z to logic LOW) applies when no WRITES were previously in progress on the bus. If a previous WRITE was in progress, DQS could be HIGH during this time, depending on t_{DQSS} .
20. MIN (t_{RC} or t_{RFC}) for I_{DD} measurements is the smallest multiple of t_{CK} that meets the minimum absolute value for the respective parameter. $t_{RAS}(MAX)$ for I_{DD} measurements is the largest multiple of t_{CK} that meets the maximum absolute value for t_{RAS} .
21. The refresh period 64ms. This equates to an average refresh rate of 15.625 μs (64MB) or 7.8125 μs (128MB, 256MB). However, an AUTO REFRESH command must be asserted at least once every

140.6 μ s (64MB) or 70.3 μ s (128MB, 256MB); burst refreshing or posting by the DRAM controller greater than eight refresh cycles is not allowed.

22. The valid data window is derived by achieving other specifications: t_{HP} ($t_{CK}/2$), t_{DQSQ} , and t_{QH} ($t_{QH} = t_{HP} - t_{QHS}$). The data valid window derates directly proportional with the clock duty cycle and a practical data valid window can be derived. The clock is allowed a maximum duty cycle variation of 45/55, beyond which functionality is uncertain. Figure 6, Derating Data Valid Window ($t_{QH} = t_{HP} - t_{QHS}$), shows derating curves for duty cycles ranging between 50/50 and 45/55.
23. Each byte lane has a corresponding DQS.
24. This limit is actually a nominal value and does not result in a fail value. CKE is HIGH during REFRESH command period (t_{RFC} [MIN]) else CKE is LOW (i.e., during standby).
25. To maintain a valid level, the transitioning edge of the input must:
 - a. Sustain a constant slew rate from the current AC level through to the target AC level, V_{IL} (AC) or V_{IH} (AC).
 - b. Reach at least the target AC level.
- c. After the AC target level is reached, continue to maintain at least the target DC level, V_{IL} (DC) or V_{IH} (DC).
26. JEDEC specifies CK and CK# input slew rate must be $\geq 1V/ns$ (2V/ns differentially).
27. DQ and DM input slew rates must not deviate from DQS by more than 10 percent. If the DQ/DM/DQS slew rate is less than 0.5V/ns, timing must be derated: 50ps must be added to t_{DS} and t_{DH} for each 100mv/ns reduction in slew rate. If slew rate exceeds 4V/ns, functionality is uncertain.
28. VDD must not vary more than 4 percent if CKE is not active while any bank is active.
29. The clock is allowed up to $\pm 150ps$ of jitter. Each timing parameter is allowed to vary by the same amount.
30. t_{HP} min is the lesser of t_{CL} minimum and t_{CH} minimum actually applied to the device CK and CK# inputs, collectively during bank active.
31. READs and WRITEs with auto precharge are not allowed to be issued until t_{RAS} (MIN) can be satisfied prior to the internal precharge command being issued.

Figure 6: Derating Data Valid Window
($t_{QH} = t_{HP} - t_{QHS}$)

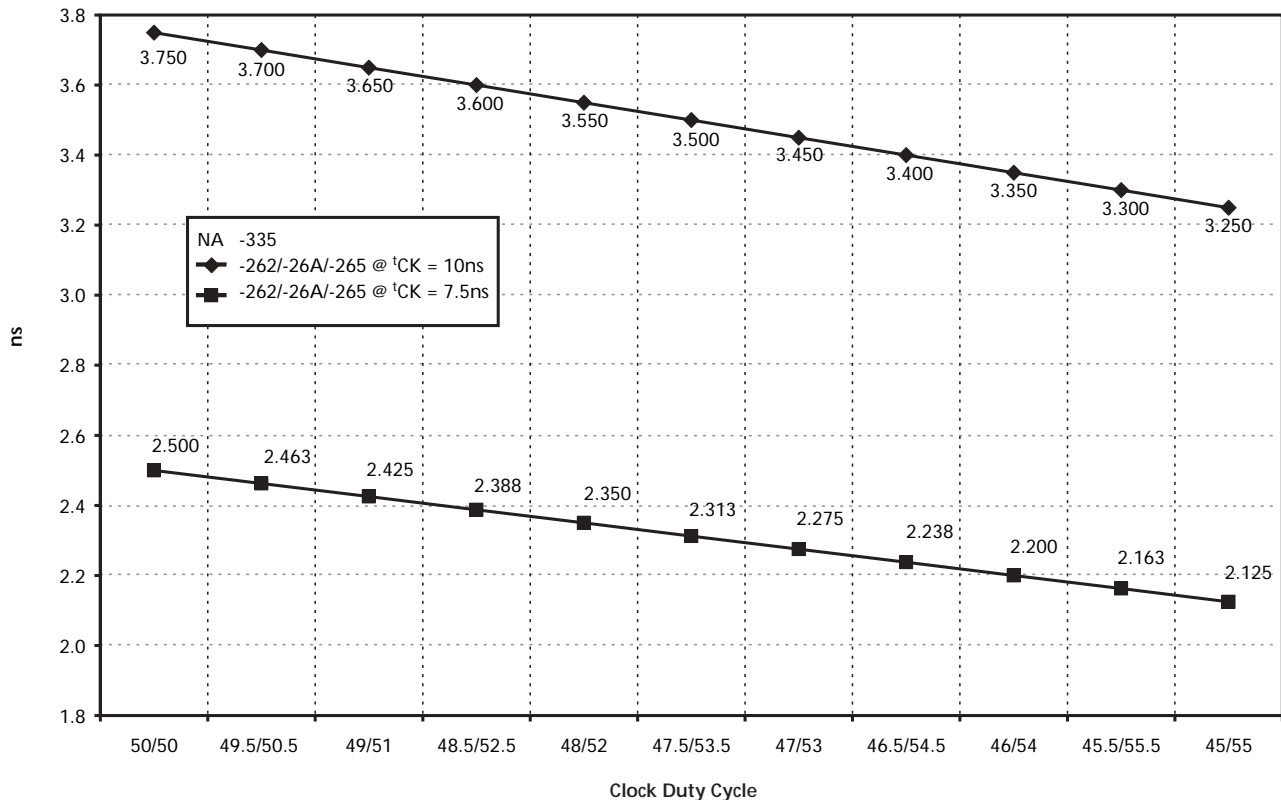

32. Any positive glitch in the nominal voltage must be less than 1/3 of the clock and not more than +400mV or 2.9V, whichever is less. Any negative glitch must be less than 1/3 of the clock cycle and not exceed either 300mV or 2.2V, whichever is more positive. However, the DC average cannot be below 2.3V minimum.
33. Normal Output Drive Curves:
- The full variation in driver pull-down current from minimum to maximum process, temperature and voltage will lie within the outer bounding lines of the V-I curve of Figure 7, Normal Drive Pull-Down Characteristics.
 - The variation in driver pull-down current within nominal limits of voltage and temperature is expected, but not guaranteed, to lie within the inner bounding lines of the V-I curve of Figure 7, Normal Drive Pull-Down Characteristics.
 - The full variation in driver pull-up current from minimum to maximum process, temperature and voltage will lie within the outer bounding lines of the V-I curve of Figure 8, Normal Drive Pull-Up Characteristics.
 - The variation in driver pull-up current within nominal limits of voltage and temperature is expected, but not guaranteed, to lie within the inner bounding lines of the V-I curve of Figure 8, Normal Drive Pull-Up Characteristics.
 - The full variation in the ratio of the maximum to minimum pull-up and pull-down current should be between 0.71 and 1.4, for device drain-to-source voltages from 0.1V to 1.0 Volt, and at the same voltage and temperature.
- f. The full variation in the ratio of the nominal pull-up to pull-down current should be unity ± 10 percent, for device drain-to-source voltages from 0.1V to 1.0V.
34. Reduced Output Drive Curves:
- The full variation in driver pull-down current from minimum to maximum process, temperature and voltage will lie within the outer bounding lines of the V-I curve of Figure 9, Reduced Drive Pull-Down Characteristics, on page 21.
 - The variation in driver pull-down current within nominal limits of voltage and temperature is expected, but not guaranteed, to lie within the inner bounding lines of the V-I curve of Figure 9, Reduced Drive Pull-Down Characteristics, on page 21.
 - The full variation in driver pull-up current from minimum to maximum process, temperature and voltage will lie within the outer bounding lines of the V-I curve of Figure 10, Reduced Drive Pull-Up Characteristics, on page 21.
 - The variation in driver pull-up current within nominal limits of voltage and temperature is expected, but not guaranteed, to lie within the inner bounding lines of the V-I curve of Figure 10, Reduced Drive Pull-Up Characteristics, on page 21.
 - The full variation in the ratio of the maximum to minimum pull-up and pull-down current should be between 0.71 and 1.4, for device drain-to-source voltages from 0.1V to 1.0V, and at the same voltage.

Figure 7: Normal Drive Pull-Down Characteristics

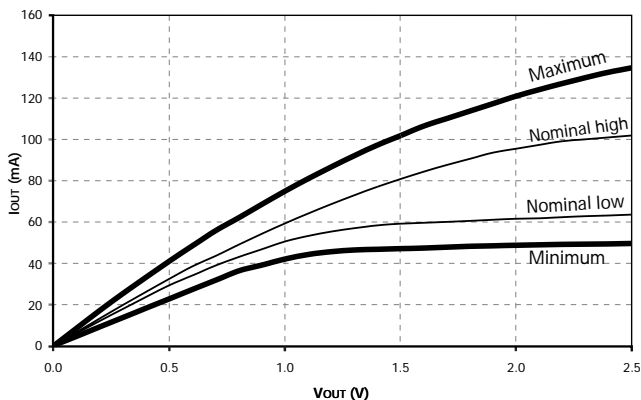

Figure 8: Normal Drive Pull-Up Characteristics

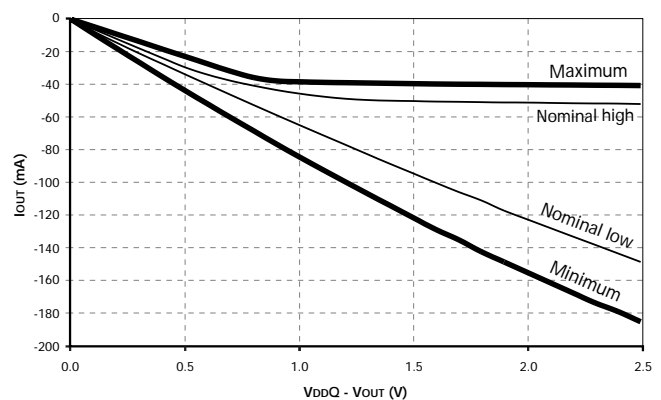

Figure 9: Reduced Drive Pull-Down Characteristics

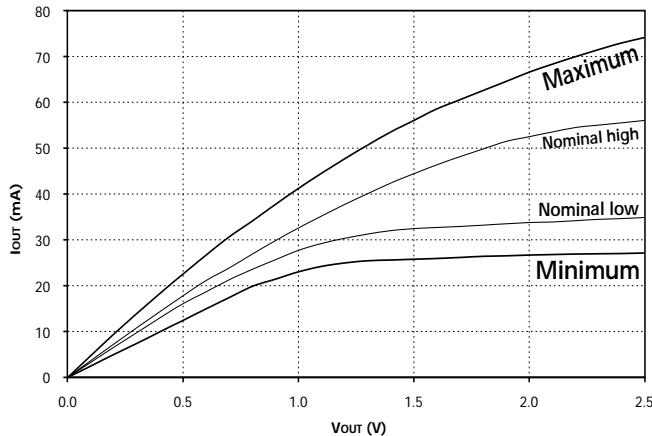
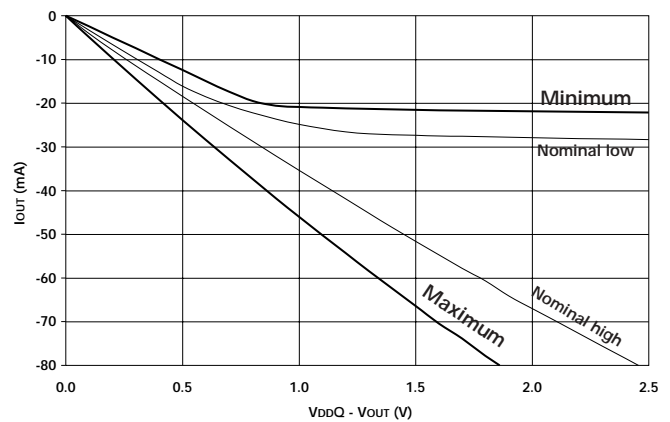

Figure 10: Reduced Drive Pull-Up Characteristics



- f) The full variation in the ratio of the nominal pull-up to pull-down current should be unity ± 10 percent, for device drain-to-source voltages from 0.1V to 1.0V.
- g. The voltage levels used are derived from a minimum VDD level and the referenced test load. In practice, the voltage levels obtained from a properly terminated bus will provide significantly different voltage values.
35. VIH overshoot: $V_{IH} (MAX) = V_{DDQ} + 1.5V$ for a pulse width $\leq 3ns$ and the pulse width can not be greater than 1/3 of the cycle rate. VIL undershoot: $V_{IL} (MIN) = -1.5V$ for a pulse width $\leq 3ns$ and the pulse width can not be greater than 1/3 of the cycle rate.
 36. VDD and VDDQ must track each other.
 37. $t_{HZ} (MAX)$ takes precedence over $t_{DQSCK} (MAX) + t_{RPST} (MAX)$ condition. $t_{LZ} (MIN)$ will prevail over $t_{DQSCK} (MIN) + t_{RPRE} (MAX)$ condition.
 38. t_{RPST} end point and t_{RPRE} begin point are not referenced to a specific voltage level but specify when the device output is no longer driving (t_{RPST}), or begins driving (t_{RPRE}).
 39. During initialization, VDDQ, VTT, and VREF must be equal to or less than VDD + 0.3V. Alternatively, VTT may be 1.35V maximum during power up, even if VDD/VDDQ are 0V, provided a minimum of 42 Ω of series resistance is used between the VTT supply and the input pin.
 40. For -335, -262, -26A and -265 speed grades, IDD3N is specified to be 35mA per DDR SDRAM at 100 MHz.

41. The current Micron part operates below the slowest JEDEC operating frequency of 83 MHz. As such, future die may not reflect this option.
42. Random addressing changing and 50 percent of data changing at every transfer.
43. Random addressing changing and 100 percent of data changing at every transfer.
44. CKE must be active (high) during the entire time a refresh command is executed. That is, from the time the AUTO REFRESH command is registered, CKE must be active at each rising clock edge, until t_{REF} later.
45. IDD2N specifies the DQ, DQS, and DM to be driven to a valid high or low logic level. IDD2Q is similar to IDD2F except IDD2Q specifies the address and control inputs to remain stable. Although IDD2F, IDD2N, and IDD2Q are similar, IDD2F is "worst case."
46. Whenever the operating frequency is altered, not including jitter, the DLL is required to be reset. This is followed by 200 clock cycles.
47. Leakage number reflects the worst case leakage possible through the module pin, not what each memory device contributes.
48. When an input signal is HIGH or LOW, it is defined as a steady state logic HIGH or LOW.
49. The -335 speed grade will operate with $t_{RAS} (MIN) = 40ns$ and $t_{RAS} (MAX) = 120,000ns$ at any slower frequency.

Initialization

To ensure device operation the DRAM must be initialized as described below:

1. Simultaneously apply power to VDD and VDDQ.
2. Apply VREF and then VTT power.
3. Assert and hold CKE at a LVCMOS logic low.
4. Provide stable CLOCK signals.
5. Wait at least 200 μ s.
6. Bring CKE high and provide at least one NOP or DESELECT command. At this point the CKE input changes from a LVCMOS input to a SSTL2 input only and will remain a SSTL_2 input unless a power cycle occurs.
7. Perform a PRECHARGE ALL command.
8. Wait at least t_{RP} time, during this time NOPs or DESELECT commands must be given.
9. Using the LMR command program the Extended Mode Register (E0 = 0 to enable the DLL and E1 = 0 for normal drive or E1 = 1 for reduced drive, E2 through En must be set to 0; where n = most significant bit).
10. Wait at least t_{MRD} time, only NOPs or DESELECT commands are allowed.
11. Using the LMR command program the Mode Register to set operating parameters and to reset the DLL. Note at least 200 clock cycles are required between a DLL reset and any READ command.
12. Wait at least t_{MRD} time, only NOPs or DESELECT commands are allowed.
13. Issue a PRECHARGE ALL command.
14. Wait at least t_{RP} time, only NOPs or DESELECT commands are allowed.
15. Issue an AUTO REFRESH command (Note this may be moved prior to step 13).
16. Wait at least t_{RFC} time, only NOPs or DESELECT commands are allowed.
17. Issue an AUTO REFRESH command (Note this may be moved prior to step 13).
18. Wait at least t_{RFC} time, only NOPs or DESELECT commands are allowed.
19. Although not required by the Micron device, JEDEC requires a LMR command to clear the DLL bit (set M8 = 0). If a LMR command is issued the same operating parameters should be utilized as in step 11.
20. Wait at least t_{MRD} time, only NOPs or DESELECT commands are allowed.
21. At this point the DRAM is ready for any valid command. Note 200 clock cycles are required between step 11 (DLL Reset) and any READ command.

Figure 11: Initialization Flow Diagram

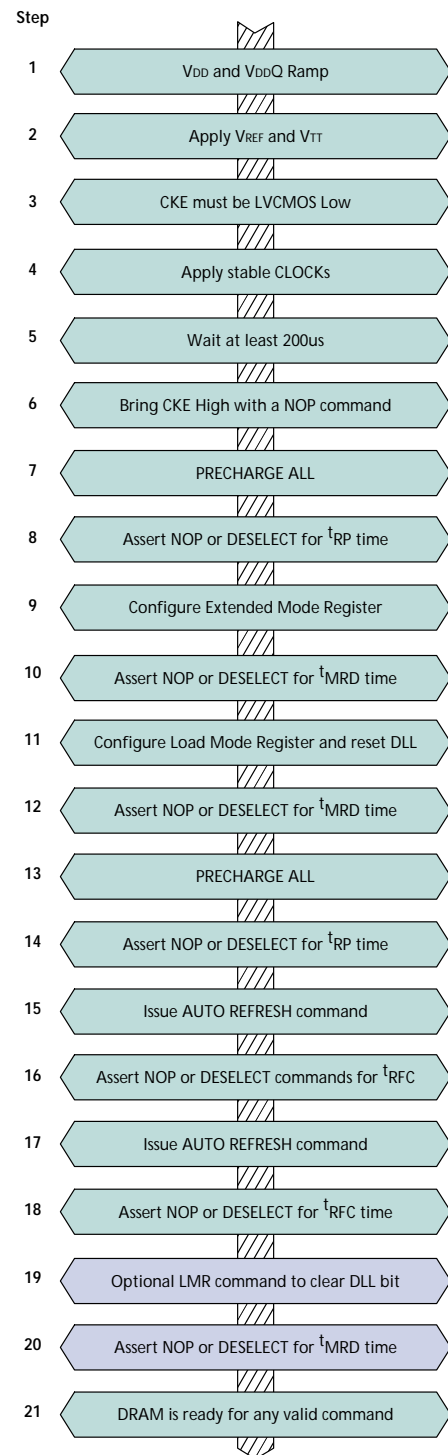

SPD Clock and Data Conventions

Data states on the SDA line can change only during SCL LOW. SDA state changes during SCL HIGH are reserved for indicating start and stop conditions (as shown in Figure 12, Data Validity, and Figure 13, Definition of Start and Stop).

SPD Start Condition

All commands are preceded by the start condition, which is a HIGH-to-LOW transition of SDA when SCL is HIGH. The SPD device continuously monitors the SDA and SCL lines for the start condition and will not respond to any command until this condition has been met.

SPD Stop Condition

All communications are terminated by a stop condition, which is a LOW-to-HIGH transition of SDA when SCL is HIGH. The stop condition is also used to place the SPD device into standby power mode.

SPD Acknowledge

Acknowledge is a software convention used to indicate successful data transfers. The transmitting device, either master or slave, will release the bus after transmitting eight bits. During the ninth clock cycle, the receiver will pull the SDA line LOW to acknowledge that it received the eight bits of data (as shown in Figure 14, Acknowledge Response from Receiver).

The SPD device will always respond with an acknowledge after recognition of a start condition and its slave address. If both the device and a write operation have been selected, the SPD device will respond with an acknowledge after the receipt of each subsequent eight-bit word. In the read mode the SPD device will transmit eight bits of data, release the SDA line and monitor the line for an acknowledge. If an acknowledge is detected and no stop condition is generated by the master, the slave will continue to transmit data. If an acknowledge is not detected, the slave will terminate further data transmissions and await the stop condition to return to standby power mode.

Figure 12: Data Validity

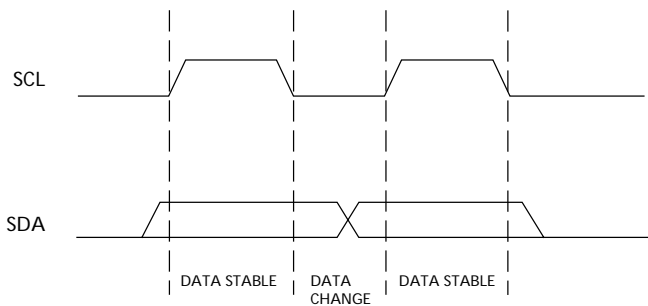

Figure 13: Definition of Start and Stop

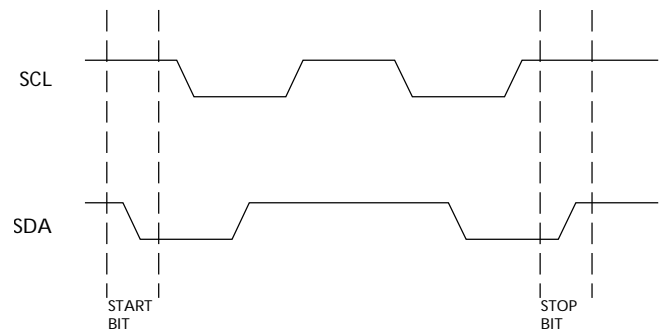

Figure 14: Acknowledge Response from Receiver

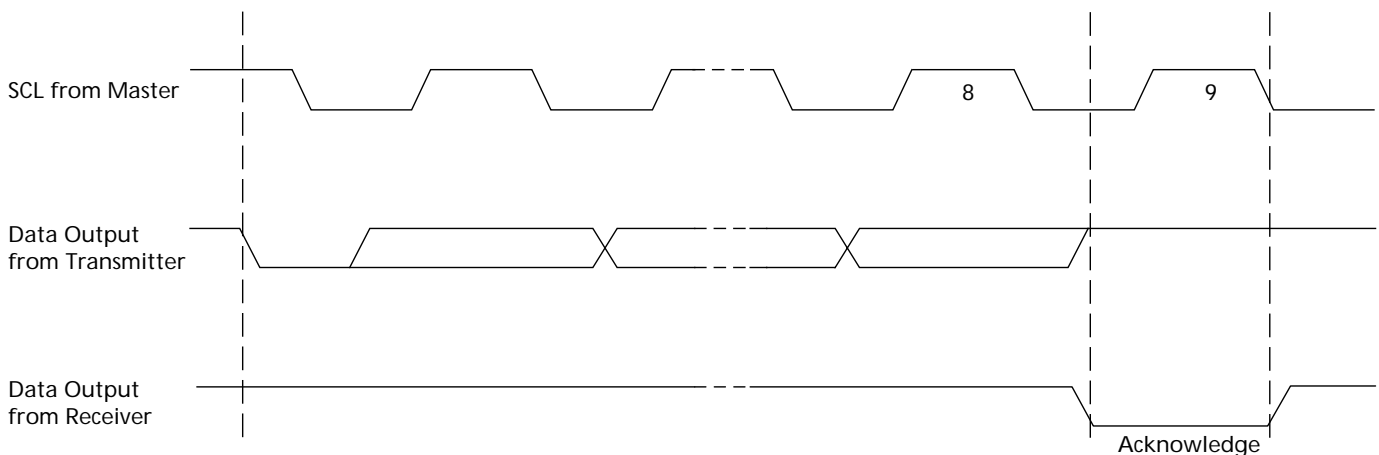

Table 17: EEPROM Device Select Code

Most significant bit (b7) is sent first

SELECT CODE	DEVICE TYPE IDENTIFIER				CHIP ENABLE			R \overline{W}
	b7	b6	b5	b4	b3	b2	b1	b0
Memory Area Select Code (two arrays)	1	0	1	0	SA2	SA1	SA0	R \overline{W}
Protection Register Select Code	0	1	1	0	SA2	SA1	SA0	R \overline{W}

Table 18: EEPROM Operating Modes

MODE	R \overline{W} BIT	\overline{WC}	BYTES	INITIAL SEQUENCE
Current Address Read	1	V _{IH} or V _{IL}	1	START, Device Select, R \overline{W} = "1"
Random Address Read	0	V _{IH} or V _{IL}	1	START, Device Select, R \overline{W} = "0", Address
	1	V _{IH} or V _{IL}	1	reSTART, Device Select, R \overline{W} = "1"
Sequential Read	1	V _{IH} or V _{IL}	≥ 1	Similar to Current or Random Address Read
Byte Write	0	V _{IL}	1	START, Device Select, R \overline{W} = "0"
Page Write	0	V _{IL}	≤ 16	START, Device Select, R \overline{W} = "0"

Figure 15: SPD EEPROM Timing Diagram

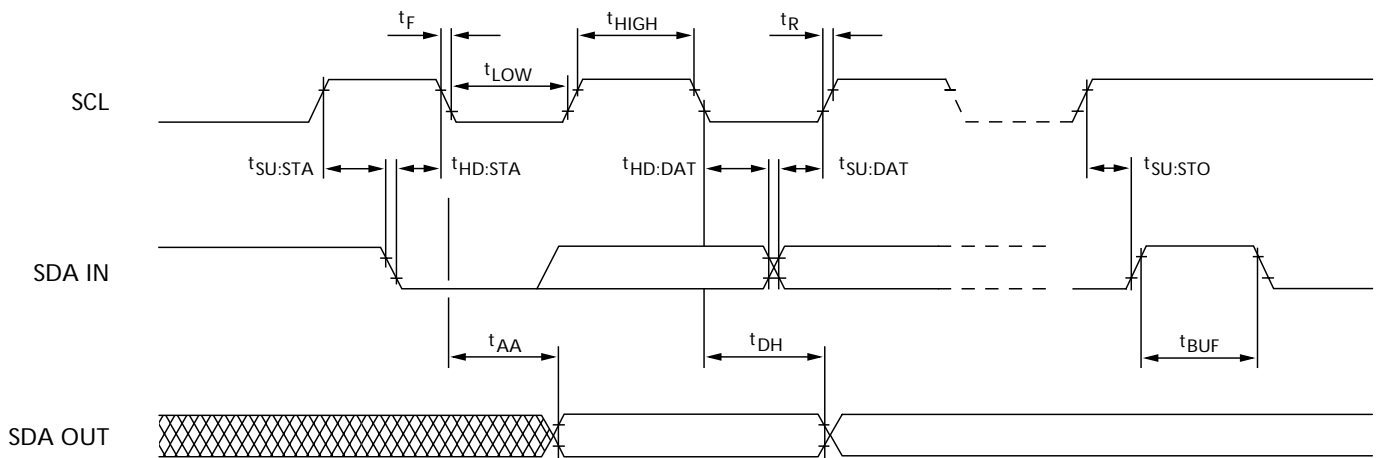

UNDEFINED

Table 19: Serial Presence-Detect EEPROM DC Operating Conditions

 All voltages referenced to V_{SS}; V_{DDSPD} = +2.3V to +3.6V

PARAMETER/CONDITION	SYMBOL	MIN	MAX	UNITS
SUPPLY VOLTAGE	V _{DD}	2.3	3.6	V
INPUT HIGH VOLTAGE: Logic 1; All inputs	V _{IH}	V _{DD} x 0.7	V _{DD} + 0.5	V
INPUT LOW VOLTAGE: Logic 0; All inputs	V _{IL}	-1	V _{DD} x 0.3	V
OUTPUT LOW VOLTAGE: I _{OUT} = 3mA	V _{OL}	-	0.4	V
INPUT LEAKAGE CURRENT: V _{IN} = GND to V _{DD}	I _{LI}	-	10	μA
OUTPUT LEAKAGE CURRENT: V _{OUT} = GND to V _{DD}	I _{LO}	-	10	μA
STANDBY CURRENT: SCL = SDA = V _{DD} - 0.3V; All other inputs = V _{SS} or V _{DD}	I _{SB}	-	30	μA
POWER SUPPLY CURRENT: SCL clock frequency = 100 KHz	I _{DD}	-	2	mA

Table 20: Serial Presence-Detect EEPROM AC Operating Conditions

 All voltages referenced to V_{SS}; V_{DDSPD} = +2.3V to +3.6V

PARAMETER/CONDITION	SYMBOL	MIN	MAX	UNITS	NOTES
SCL LOW to SDA data-out valid	t _{AA}	0.2	0.9	μs	1
Time the bus must be free before a new transition can start	t _{BUF}	1.3		μs	
Data-out hold time	t _{DH}	200		ns	
SDA and SCL fall time	t _F		300	ns	2
Data-in hold time	t _{HD:DAT}	0		μs	
Start condition hold time	t _{HD:STA}	0.6		μs	
Clock HIGH period	t _{HIGH}	0.6		μs	
Noise suppression time constant at SCL, SDA inputs	t _I		50	ns	
Clock LOW period	t _{LOW}	1.3		μs	
SDA and SCL rise time	t _R		0.3	μs	2
SCL clock frequency	f _{SCL}		400	KHz	
Data-in setup time	t _{SU:DAT}	100		ns	
Start condition setup time	t _{SU:STA}	0.6		μs	3
Stop condition setup time	t _{SU:STO}	0.6		μs	
WRITE cycle time	t _{WRC}		10	ms	4

NOTE:

1. To avoid spurious START and STOP conditions, a minimum delay is placed between SCL = 1 and the falling or rising edge of SDA.
2. This parameter is sampled.
3. For a reSTART condition, or following a WRITE cycle.
4. The SPD EEPROM WRITE cycle time (t_{WRC}) is the time from a valid stop condition of a write sequence to the end of the EEPROM internal erase/program cycle. During the WRITE cycle, the EEPROM bus interface circuit is disabled, SDA remains HIGH due to pull-up resistor, and the EEPROM does not respond to its slave address.

Table 21: Serial Presence- Detect Matrix

"1"/"0": Serial Data, "driven to HIGH"/"driven to LOW"; notes appear on page 27

BYTE	DESCRIPTION	ENTRY (VERSION)	MT4VDDT864A	MT4VDDT1664A	MT4VDDT3264A
0	Number of SPD Bytes Used by Micron	128	80	80	80
1	Total Number of Bytes in SPD Device	256	08	08	08
2	Fundamental Memory Type	SDRAM DDR	07	07	07
3	Number of Row Addresses on Assembly	12 or 13	0C	0D	0D
4	Number of Column Addresses on Assembly	9 or 10	09	09	0A
5	Number of Physical Ranks on DIMM	1	01	01	01
6	Module Data Width	64	40	40	40
7	Module Data Width (Continued)	0	00	00	00
8	Module Voltage Interface Levels	SSTL 2.5V	04	04	04
9	SDRAM Cycle Time, ^t CK, (CAS Latency = 2.5) (See note 1)	6ns (-335) 7ns (-262/-26A) 7.5ns (-265)	60 70 75	60 70 75	60 70 75
10	SDRAM Access From Clock, ^t AC, (CAS Latency = 2.5) (See note 1)	0.70ns (-335) 0.75ns (-262/-26A/-265)	70 75	70 75	70 75
11	Module Configuration Type	Non-ECC	00	00	00
12	Refresh Rate/Type	15.6µs or 7.8µs/SELF	80	82	82
13	DDR SDRAM Device Width	x16	10	10	10
14	Error-checking SDRAM Data Width	None	00	00	00
15	Minimum Clock Delay, Back-to-Back Random Column Access	1 clock	01	01	01
16	Burst Lengths Supported	2, 4, 8	0E	0E	0E
17	Number of Banks on SDRAM Device	4	04	04	04
18	CAS Latencies Supported	2, 2.5	0C	0C	0C
19	CS Latency	0	01	01	01
20	WE Latency	1	02	02	02
21	SDRAM Module Attributes	Unbuffered, Diff CLK	20	20	20
22	SDRAM Device Attributes: General	Fast/Concurrent AP	C1	C1	C1
23	SDRAM Cycle Time, ^t CK (CAS Latency = 2) (See note 1)	7.5ns (-335/-262/-26A) 10ns (-265)	75 A0	75 A0	75 A0
24	SDRAM Access From CK, ^t AC (CAS Latency = 2) (See note 1)	0.70ns (-335) 0.75ns (-262/-26A/-265)	70 75	70 75	70 75
25	SDRAM Cycle Time, ^t CK, (CAS Latency = 1.5)	N/A	00	00	00
26	SDRAM Access from CK, ^t AC, (CAS Latency = 1.5)	N/A	00	00	00
27	Minimum Row Precharge Time, ^t RP (see note 4)	18ns (-335) 15ns (-262) 20ns (-26A/-265)	48 3C 50	48 3C 50	48 3C 50
28	Minimum Row Active to Row Active, ^t R RD	12ns (-335) 15ns (-262/-26A/-265)	30 3C	30 3C	30 3C
29	Minimum RAS# to CAS# Delay, ^t RCD (see note 4)	18ns (-335) 15ns (-262) 20ns (-26A/-265)	48 3C 50	48 3C 50	48 3C 50
30	Minimum RAS# Pulse Width, ^t RAS (See note 2)	42ns (-335) 45ns (-262/-26A/-265)	2A 2D	2A 2D	2A 2D

Table 21: Serial Presence- Detect Matrix (Continued)

"1"/"0": Serial Data, "driven to HIGH"/"driven to LOW"; notes appear on page 27

BYTE	DESCRIPTION	ENTRY (VERSION)	MT4VDDT864A	MT4VDDT1664A	MT4VDDT3264A
31	Module Rank Density	64MB, 128MB, or 256MB	10	20	40
32	Address and Command Setup Time, ^t IS (See note 3)	0.8ns (-335) 1.0ns (-262/-26A/-265)	80 A0	80 A0	80 A0
33	Address and Command Hold Time, ^t IH (See note 3)	0.8ns (-335) 1.0ns (-262/-26A/-265)	80 A0	80 A0	80 A0
34	Data/Data Mask Input Setup Time, ^t DS	0.45ns (-335) 0.5ns (-262/-26A/-265)	45 50	45 50	45 50
35	Data/Data Mask Input Hold Time, ^t DH	0.45ns (-335) 0.5ns (-262/-26A/-265)	45 50	45 50	45 50
36-40	Reserved		00	00	00
41	Minimum Active/Auto Refresh Time, ^t RC	60ns (-335/-262) 65ns (-26A/-265)	3C 41	3C 41	3C 41
42	Minimum Auto Refresh to Active/ Auto Refresh Command Period, ^t RFC	72ns (-335) 75ns (-262/-26A/-265)	48 4B	48 4B	48 4B
43	Maximum Cycle Time, ^t CK (MAX)	12ns (-335) 13ns (-262/-26A/-265)	30 34	30 34	30 34
44	Maximum DQS-DQ Skew Time, ^t DOSQ	0.45ns (-335) 0.5ns (-262/-26A/-265)	2D 32	2D 32	2D 32
45	Maximum Read Data Hold Skew Factor, ^t QHS	0.55ns (-335) 0.75ns (-262/-26A/-265)	55 75	55 75	55 75
46	Reserved		00	00	00
47	DIMM Height	Standard	01	01	01
48-61	Reserved		00	00	00
62	SPD Revision	Release 1.0	10	10	10
63	Checksum For Bytes 0-62	-335 -262 -26A -265	FC 8F BC EC	0F A2 CF FF	33 C3 F0 20
64	Manufacturer's JEDEC ID Code	MICRON	2C	2C	2C
65-71	Manufacturer's JEDEC ID Code (cont.)		FF	FF	FF
72	Manufacturing Location	1 - 12	01 - 0C	01 - 0C	01 - 0C
73-90	Module Part Number (ASCII)		Variable Data	Variable Data	Variable Data
91	PCB Identification Code	1 - 9	01 - 09	01 - 09	01 - 09
92	Identification Code (Continued)	0	00	00	00
93	Year of Manufacture in BCD		Variable Data	Variable Data	Variable Data
94	Week of Manufacture in BCD		Variable Data	Variable Data	Variable Data
95-98	Module Serial Number		Variable Data	Variable Data	Variable Data
99-127	Manufacturer-Specific Data (RSVD)		-	-	-

NOTE:

- Value for -26A/-265 ^tCK set to 7ns (0x70) for optimum BIOS compatibility. Actual device spec value is 7.5ns.
- The value of ^tRAS used for the -26A/-265 module is calculated from ^tRC- ^tRP. Actual device spec. value is 40ns.
- The JEDEC SPD specification allows fast or slow slew rate values for these bytes. The worst-case (slow slew rate) value is represented here. Systems requiring the fast slew rate setup and hold values are supported, provided the faster minimum slew rate is met.
- The value of ^tRP, ^tRCD and ^tRAP for -335 modules indicated as 18ns to align with industry specifications; actual DDR SDRAM device specification is 15ns.

Figure 16: 184-Pin DIMM Dimensions

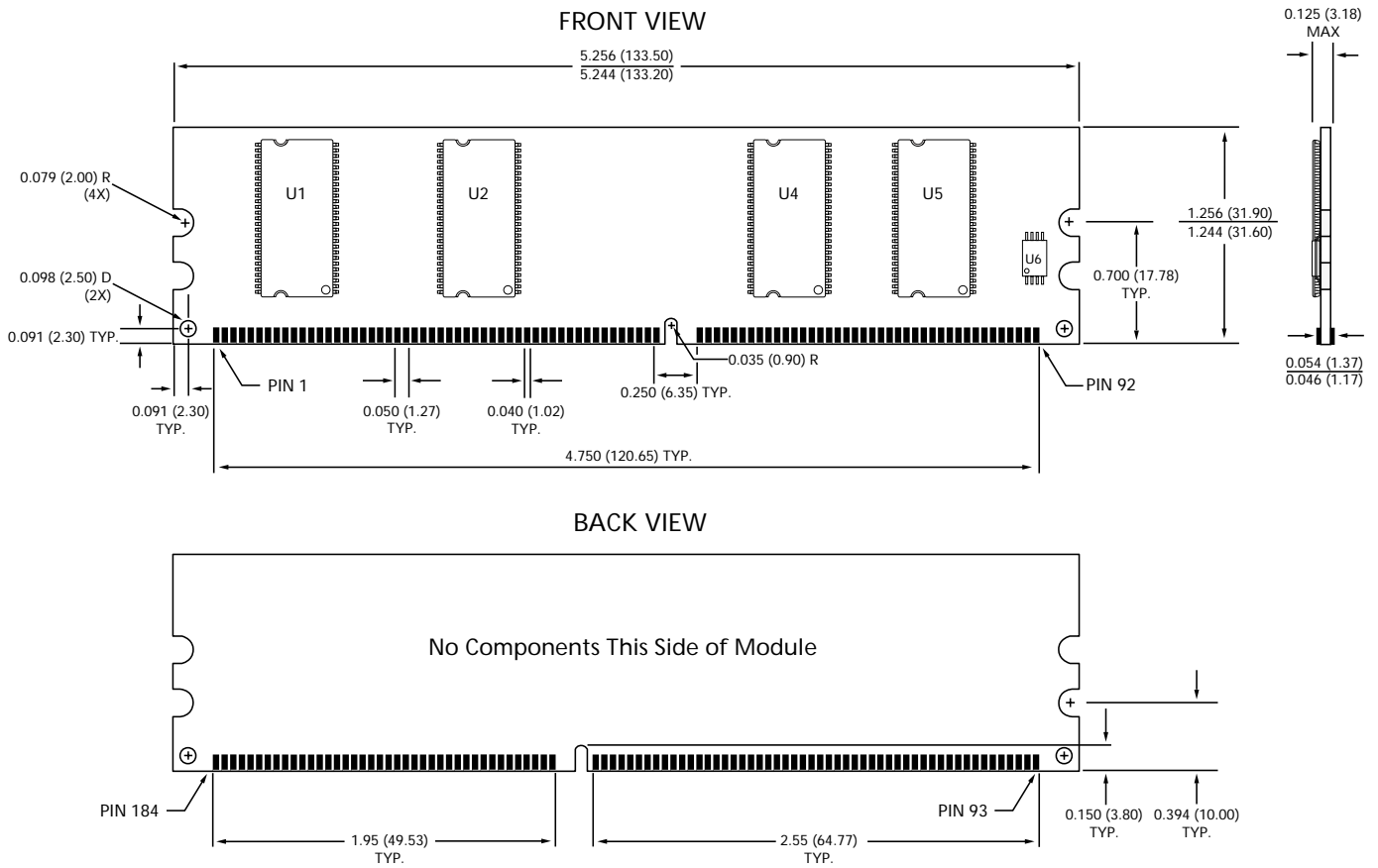

NOTE:

All dimensions are in inches (millimeters); $\frac{\text{MAX}}{\text{MIN}}$ or typical where noted.

Data Sheet Designation

Released (No Mark): This data sheet contains minimum and maximum limits specified over the complete power supply and temperature range for production

devices. Although considered final, these specifications are subject to change, as further product development and data characterization sometimes occur.



8000 S. Federal Way, P.O. Box 6, Boise, ID 83707-0006, Tel: 208-368-3900

E-mail: prodmtg@micron.com, Internet: <http://www.micron.com>, Customer Comment Line: 800-932-4992

Micron, the M logo, and the Micron logo are trademarks and/or service marks of Micron Technology, Inc.

All other trademarks are the property of their respective owners.