

1 2 3 4 5 6

A

B

C

D

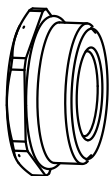
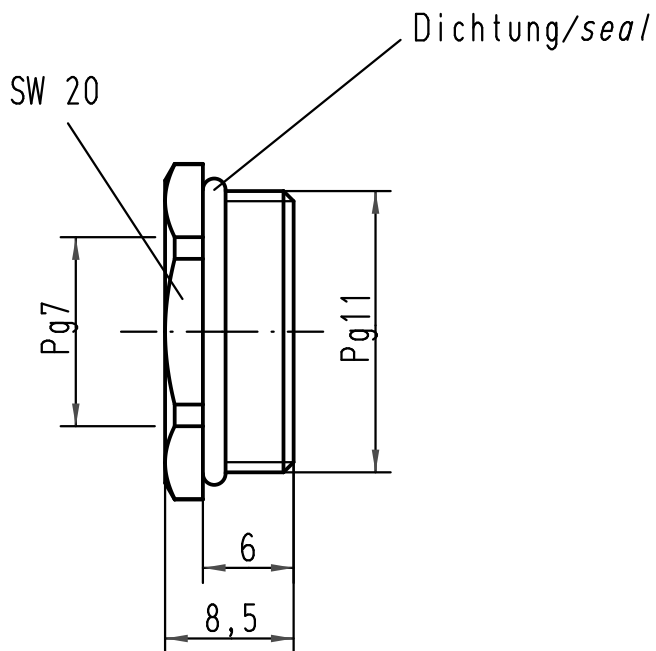

		All Dimensions in mm Original Size DIN A 4		Techn. Character.		Nicht tolerierte Maße/ Free size tolerances	
				Dat. 19.11.10	Name ML	Maßstab/ Scale 2:1	Reduktion/ <i>reducer</i>
				Insp.	Be		
				Stand.			
A		HARTING Electric GmbH & Co. KG D-32339 Espelkamp				TB 09 00 000 5060	
Mod.	Dat.	Name			Sub. TB 09 00 000 5060 v. 11.12.98		Blatt/ page