

THIS DOCUMENT IS THE PROPERTY OF
KEYSTONE ELECTRONICS CORP. AND
SHALL NOT BE REPRODUCED, DISTRIBUTED
OR USED AS A BASIS FOR MANUFACTURE
WITHOUT PRIOR WRITTEN PERMISSION
FROM KEYSTONE ELECTRONICS CORP.

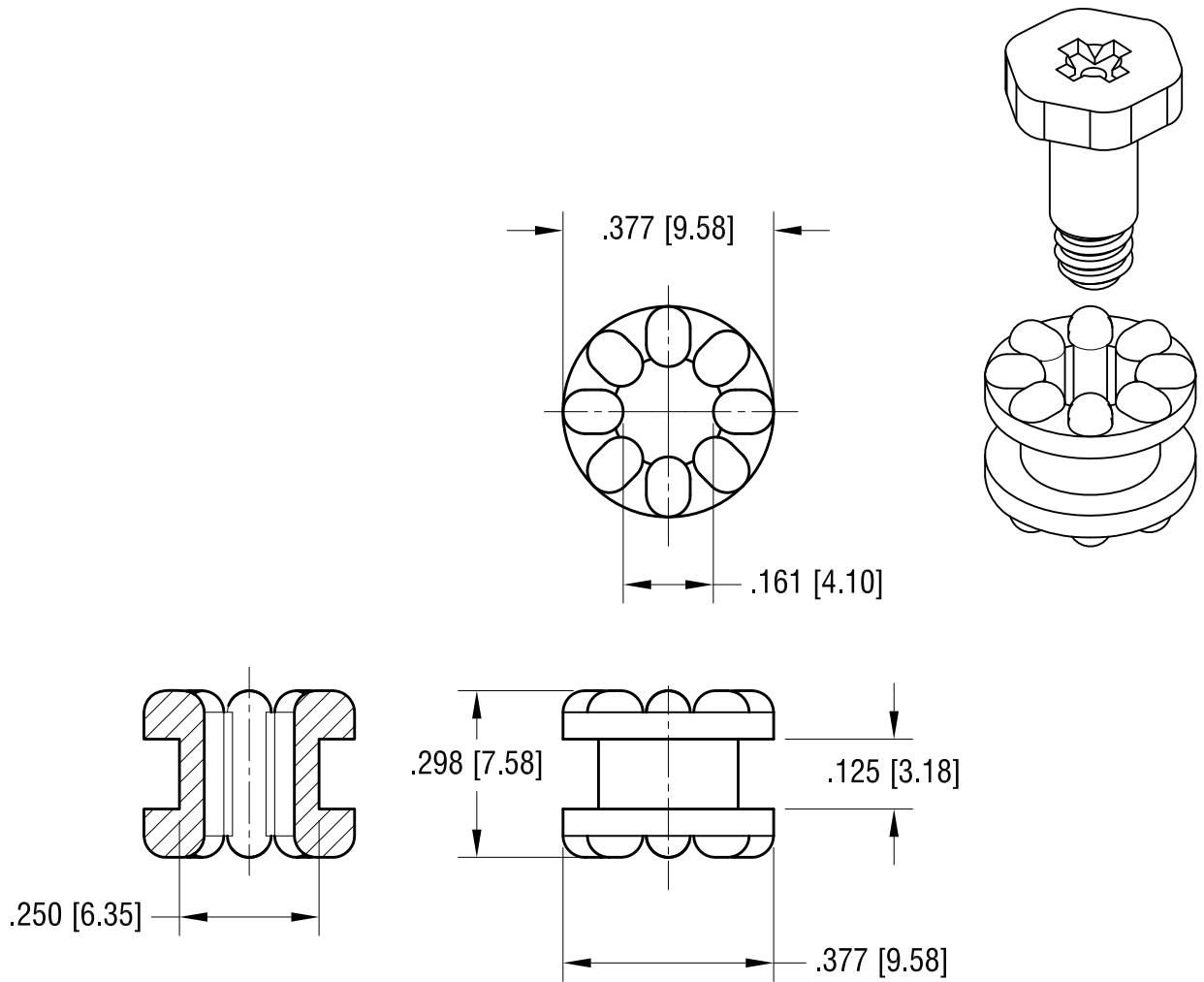

NOTE:

1. GROMMET: MAT'L- THERMOPLASTIC RUBBER
(BLACK COLOR)
2. MOUNTING SCREW P/N 2512 (6-32 THREAD)
(SUPPLIED UNASSEMBLED)
MAT'L-STELL
FINISH- NICKEL PLATE

KEYSTONE ELECTRONICS CORP.			
www.keyelco.com • ASTORIA, N.Y. 11105-2017 • Tel (718) 956-8900			
PART NAME			
ANTI-VIBRATE GROMMET ASSEMBLY			
MATERIAL			
AS NOTED			
FINISH		DRN BY	DATE
AS NOTED		NT	12.14.10
		APP'D	SCALE
		LN	3X
TOLERANCES	INCH [MM]	CODE	DWG NO.
DECIMAL	± .005 [± 0.13]	C	769
ANGULAR	± 1°		
UNLESS OTHERWISE SPECIFIED			

8.05.11	CHANGE AS PER ECN 11-101	A
DATE	DESCRIPTION	REV.