

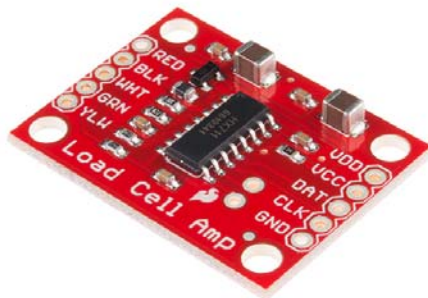

# Load Cell Amplifier HX711 Breakout Hookup Guide

## Getting Started

The HX711 load cell amplifier is used to get measurable data out from a load cell and strain gauge. This Hookup Guide will show you how to get started with this amplifier using some of the various load cells we carry at SparkFun.



## What You Will Need:

For this simple hook up guide we will just be hooking up a load cell with the HX711 amplifier, and showing how you would hook up four load sensors with a combinator board and the HX711 amplifier. To follow along, you'll need:

- SparkFun Load Cell Amplifier - HX711
- Any Strain Gauge Based Load Cell:



Load Cell - 200kg, Disc  
(TAS606)

© SEN-13332



Load Cell - 50kg, Disc  
(TAS606)

© SEN-13331



**Load Cell - 10kg, Straight Bar (TAL220)**

● SEN-13329



**Load Cell - 10kg, Wide Bar (TAL201)**

● SEN-13330

If you are planning on using load sensors<sup>1</sup> you will need to obtain or purchase four units. We recommend our Combinator Board to make it easy to turn the four strain gauges into a wheatstone bridge type load cell. (Single strain gauge load cells only have three wires instead of four.)

## Suggested Reading

If you aren't familiar with the following concepts, we recommend reviewing them before beginning to work with the HX711 Load Cell Amplifier Board.

- Load Cell Basics
- Getting Started with Load Cells
- Installing the Arduino IDE
- How to Power Your Project
- Battery Technologies
- How to Solder

1. [Strain gauges are two wired organized metal foil or wires that are set up in such a way that the resistance changes when it is compressed or stretched. When a strain gauge is placed on something (usually metallic in nature) its resistance changes based on the stress experienced by that something. When a single strain gauge is hooked up to a metallic cell, we are calling that a load sensors, which have three output wires. Load cells usually has four strain gauges hooked up in a wheatstone bridge formation, which have four output wires. For more information on load cells, strain gauges, and wheatstone bridges see our tutorial.]--

## Load Cell Set Up



*A selection of different load cells*

Depending on the type of load cell you are using, the configuration of how it should be hooked up to plates or surfaces will change. Below are a few different types of setups.



*Bar load cell between a two plate configuration*



*S load cell configuration*

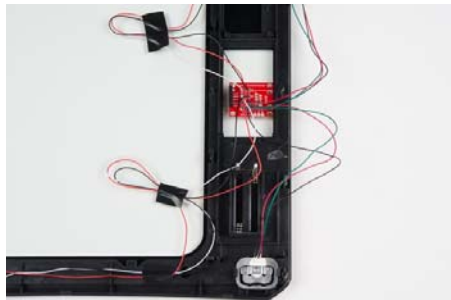

*Possible four disc load cell configuration in something like a bathroom scale*



*Bar strain gauge based load cells*

Usually with larger, non-push button bar load cells you will want to hook up the load cell between two plates in a "Z" shape, with fitting screws and spacers so that the strain can be correctly measured as shown below:

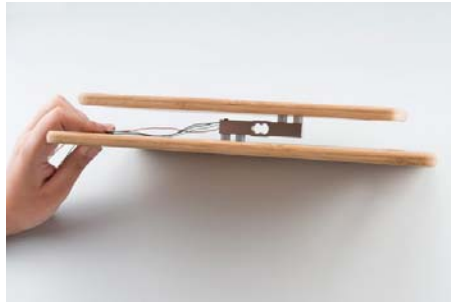

Note that only one side of the load cell is screwed into each board. This provides a moment of force, or torque, on the strain gauge rather than just compression force, which is easier to measure and much more accurate.



For smaller, push-button or disc load cells, you will want to make sure to screw in the disc to a bottom plate (or surface you are measuring force against), and center the beam, plate, or whatever else you are wishing to measure the force of onto the "button" on the top. Usually another plate with a hole is used to make sure whatever you are measuring is hitting the same spot on the load cell each time, but it is not necessary.

Make sure to read the datasheet for the load cell you are using and get the correct screws to fit into it.

- Note: If you are hooking together four of the SparkFun Load Sensors using the Combinator board, you should position the four load sensors equidistant from each other, just like the bathroom scales shown in this tutorial.

Load cell measurements can be off by +/- 5% due to a range of things including temperature, creep, vibration, drift, and other electrical and mechanical interferences. Before you install your scale, take a moment and design your system to allow for easy calibration or be able to adjust the code parameters to account for these variations.

## Hardware Hookup

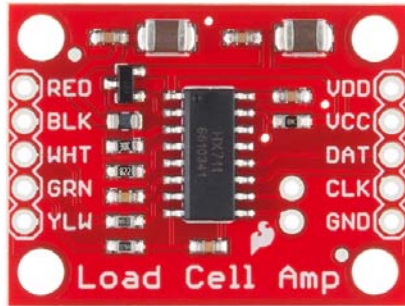

The HX711 Load Cell Amplifier accepts five wires from the load cell. These pins are labeled with colors; **RED, BLK, WHT, GRN, and YLW**. These colors correspond to the conventional color coding of load cells, where red, black, green and white wires come from the strain gauge on the load cell and yellow is an optional ground wire that is not hooked up to the strain gauge but is there to ground any small outside EMI (electromagnetic interference). Sometimes instead of a yellow wire there is a larger black wire, foil, or loose wires to shield the signal wires to lessen EMI.

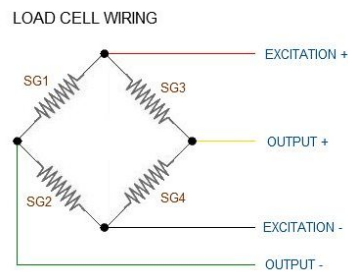

*Four strain gauges (SG1 through 4) hooked up in a wheatstone bridge formation*

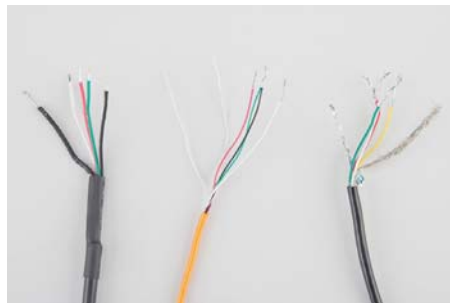

*Here we have a large black wire, some loose wires, and foil and loose wires respectively as EMI buffers*

In General, each load cell has four strain gauges that are hooked up in a wheatstone bridge formation as shown above.

The four wires coming out from the wheatstone bridge on the load cell are usually:

- Excitation+ (E+) or VCC is red
- Excitation- (E-) or ground is black.
- Output+ (O+), Signal+ (S+) or Amplifier+ (A+) is white
- O-, S-, or A- is green or blue

Some load cells might have slight variations in color coding such as blue instead of green or yellow instead of black or white if there are only four wires (meaning no wire used as an EMI buffer). You might have to infer a little from the colors that you have, but in general you will usually see these colors.

If the readings from the HX711 are opposite of what you are expect (for example the values decrease as you increase weight) simply reverse the O+/O- wires.

Once the load cell is hooked up to the amplifier, you can hook up VDD, VCC, DAT, CLK, and GND to a microcontroller such as a RedBoard or Arduino board.

**Note** VCC is the analog voltage to power the load cell. VDD is the digital supply voltage used to set the logic level.

**PRO TIP:** In many cases, you can just short VCC and VDD together. If your microcontroller uses 3.3V logic however, you'll want to connect VCC to 5V and VDD to 3.3V.



*Load cell wires hooked up to the HX711 Amplifier board*

The example code has **DAT and CLK** hooked up to **pin 3 and 2** respectively, but this is easily changed in the code. Any GPIO pin will work for either. Then VCC and VDD just need to be hooked up to 2.7-5V and GND to ground on your microcontroller.

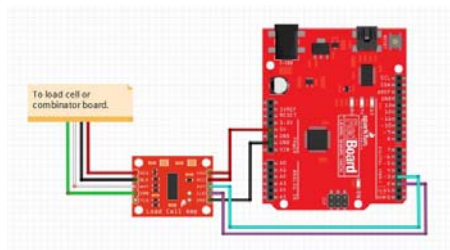

*Fritzing diagram of HX711 amplifier connected to a RedBoard*

Now, if you would like to set up four single load sensors with our combinator board and amplifier, connect the five pins labeled RED, BLK, WHT, GRN, YLW to the matching pins on the HX711. Next, connect each of the four load sensors to the following pins:

- Red → +
- Black → -
- White → C

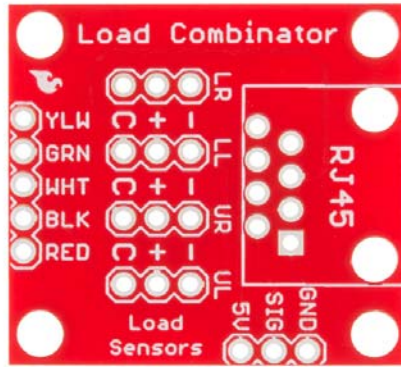

The combinator board also has room for an 8 pin RJ45 socket, which can be used to connect your project via Ethernet cables for long distance applications.

Another nice thing about our combinator board is that most home scales use four single strain gauge load sensors, so this is a handy board for hacking your own scales at home!

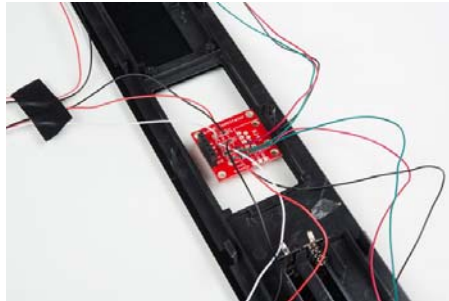

*Hacked home scale's four load sensors hooked up to our combinator board*

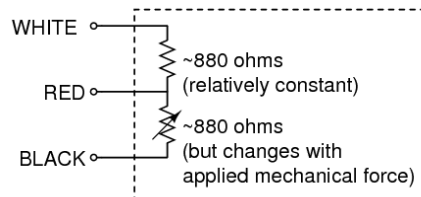

*Example of a single strain gauge, or load sensor. Here RED is the center tap*

For load sensors, there isn't a set color coded standard. Comparing the scale pictured above with the load sensor schematic, while the black wires matched, the red and white wires were swapped. Also, only two of the four sensors used a white wire for the 'center tap' of the load sensor, the other two used green. I connected the black wires to "-", the red to "+", and the white and green wires to "C".

To determine how to hook up your single strain gauge load cells to the combinator, measure the resistance between the three wires. You should find a larger resistance (close to double) between a pair. In our example the resistance between red and black was 1.6 k $\Omega$ , and the resistance between white/green and red was 800  $\Omega$ . Therefore, the center tap to the strain gauge is the white/green wire. The center tap or center pin of your strain gauge connects to the "C" pin on the combinator. The larger resistance wires (red and black in this example) connect to the "+" and "-" pins on the combinator.

The combinator board hooks up the four load sensors in such a way that two resistors in the wheatstone bridge configuration are constant values and the other two are variable in this way:



*To hook up the combinator board to the HX711 match the RED, BLK, WHT, and GRN pins*

Once you have the combinator board successfully soldered to the twelve wires, you can now connect it to the HX711 amplifier board via the 4 standard load cell wires. You can use short jumper wires or if your electronics are a long distance away from your scale consider using an RJ45 connector and an ethernet cable to connect the combinator to the HX711 amplifier.

## Arduino Code

Now that you have your load cell, amplifier, and microcontroller hooked up, you can add your code and start calibrating your setup.

You can download the most up-to-date code and libraries from the link below.

[GITHUB REPOSITORY](#)

If you have never worked with downloading Arduino libraries or need a quick reminder you might want to take a look at our tutorial on [Installing Arduino Libraries](#).

Or you can easily get started and running with everything in [Codebender!](#)

The first thing you will want to work with is the calibration code: "SparkFun\_HX711\_Calibration":



```

SparkFun_HX711_Calibration_Sketch_L1280219
referrer=sarahalmutlaq) by sarahalmutlaq
(https://codebender.io/user/sarahalmutlaq/?referrer=sarahalmutlaq)
3 By: Nathan Seidle
4 SparkFun Electronics referrer=sarahalmutlaq)er=saraha
5 Date: November 19th, 2014
6 License: This code is public domain but you buy me a beer
7
8 This is the calibration sketch. Use it to determine the ca
9 outputs the zero_factor useful for projects that have a pe
10
11 Setup your scale and start the sketch WITHOUT a weight on
12 Once readings are displayed place the weight on the scale
13 Press +/- or a/z to adjust the calibration_factor until th
14 Use this calibration_factor on the example sketch
15
16 This example assumes pounds (lbs). If you prefer kilograms
17 calibration factor will be significantly different but it
18
19 Your calibration factor may be very positive or very negat
20 and the direction the sensors deflect from zero state
21 This example code uses bogde's excellent library: https://
22 bogde's library is released under a GNU GENERAL PUBLIC LIC
23
24 To program your Arduino from your browser, please use
25 Google Chrome (http://www.google.com/chrome//Chromium
26 (version 41 and above on Linux) or Mozilla Firefox
27 (http://www.mozilla.org/en-US/firefox/) (32bit only on Windows)
28
29 Dismiss
30
Please select a board [v] [v] → Run on Arduino

```

Once you have calculated your calibration factor of your load cell set up, you can move on to other code, such as the simple scale output example code, "SparkFun\_HX711\_Example":

```

SparkFun_HX711_Example_Sketch_L1280219
referrer=sarahalmutlaq) by sarahalmutlaq
(https://codebender.io/user/sarahalmutlaq/?referrer=sarahalmutlaq)
3 By: Nathan Seidle
4 SparkFun Electronics referrer=sarahalmutlaq)er=saraha
5 Date: November 19th, 2014
6 License: This code is public domain but you buy me a beer
7
8 This example demonstrates basic scale output. See the cali
9 specific load cell setup.
10
11 This example code uses bogde's excellent library: https://
12 bogde's library is released under a GNU GENERAL PUBLIC LIC
13
14 The HX711 does one thing well: read load cells. The breako
15 based load cell which should allow a user to measure every
16 Arduino pin 2 -> HX711 CLK
17 3 -> DAT
18 5V -> VCC
19 GND -> GND
20
21 The HX711 board can be powered from 2.7V to 5V so the Ardu
22
23 To program your Arduino from your browser, please use
24 Google Chrome (http://www.google.com/chrome//Chromium
25 #include "HX711.h"
26 (version 41 and above on Linux) or Mozilla Firefox
27 #define calibration_factor -7050.0 //This value is obtained
28 (http://www.mozilla.org/en-US/firefox/) (32bit only on Windows)
29 #define DOUT 3
30 Dismiss
31
Please select a board [v] [v] → Run on Arduino

```

Check out the other example code in the Github repo, or Codebender for powering down the HX711 (github, codebender) and known zero startup (github, codebender).

## Resources and Going Further

Want to know more? Check out this tutorial if you haven't already:

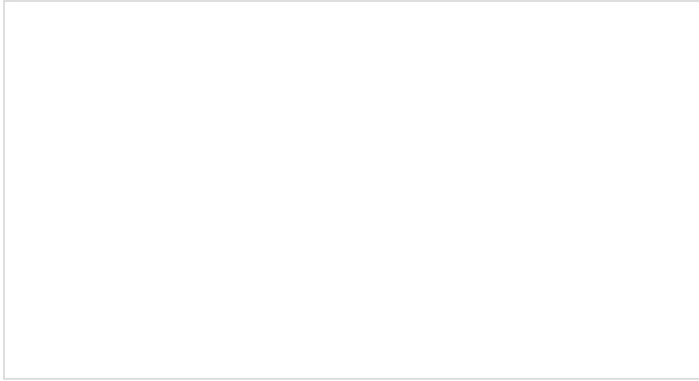

### Getting Started with Load Cells

JUNE 11, 2015

A tutorial defining what a load cell is and how to use one.

Need even more? Check out this awesome article wheatstone bridges and load cell types.