

# 1. Saturable Cores for Mag-Amps

The Mag-amp method is one of the few different output voltage regulation methods used in switching power supplies. A saturable core is used in the secondary side of the main transformer to regulate voltage by magnetic pulse width modulation (PWM). The Mag-amp method is especially effective and economically attractive in low voltage/high current circuits and is frequently used in power supplies for information processing equipment, such as desktop PCs and computer servers; in power supplies for office equipment, such as photocopier machines and printers, and in power supplies for communication equipment, such as mobile phone stations.

Miniaturization, high efficiency, low noise, high reliability, and high precision can be easily realized by adopting the Mag-amp method.

Utilizing the unique magnetic characteristics of cobalt-based amorphous alloys, we have realized low loss at high frequencies, which cannot be realized using other materials. Our lineup consists of MS series cores, which are well suited for general purpose applications, and MT cores, which have lower loss than the MS series.

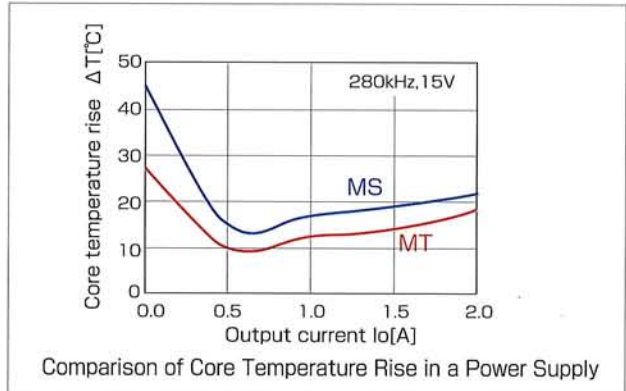
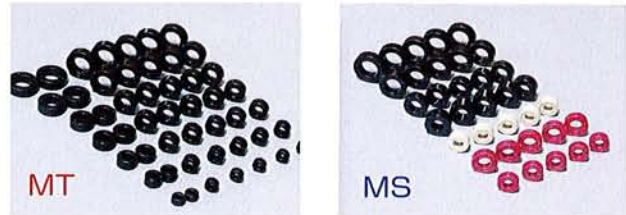
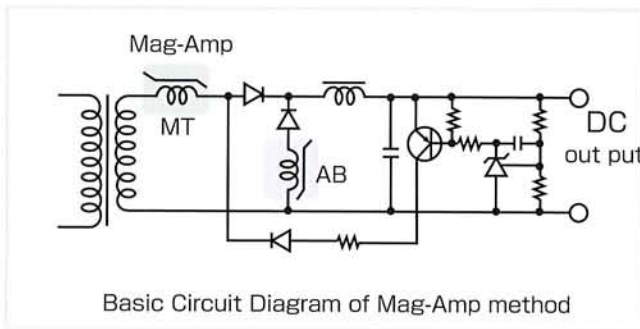

Basic Characteristics (Typical Value)

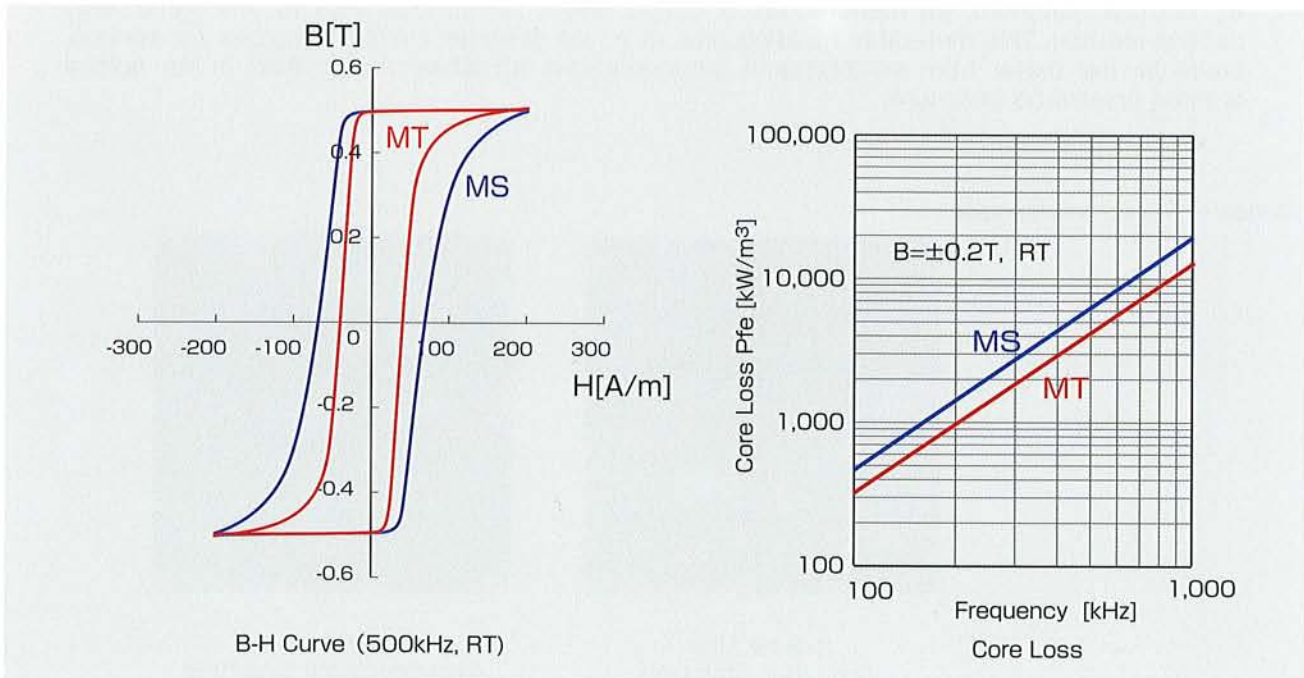

# MT / MS Series

## Standard Specifications

### MT Standard Wired Series

Type No.	Core Type No.	Wire Diameter $\phi$ [mm]	Parallel Number	N [turn]	Flux*1*2 [ $\mu$ Wb]	Example of Circuit (150kHz)*3		Finished Dimensions*4 [mm]		Lead Length C [mm]	Length of Non Solder D [mm]	Package
						Vo [V]	Io [A]	O.D.(Max)	H.T.(Max)			
MT12S115	MT12X 8X4.5W	1.0	1	15	94.7	5	6	20	13	20±5	3 max	1,000 [pcs in a box]
MT12S208		0.9	2	8	50.5	3.3	10	20	13			
MT15S125	MT15X10X4.5W	1.0	1	25	197	12	6	25	15			
MT15S214		0.9	2	14	110	5	10	25	15			
MT18S130	MT18X12X4.5W	1.0	1	30	284	15	6	28	15			
MT18S222		0.9	2	22	208	12	10	28	15			
MT21S134	MT21X14X4.5W	1.0	1	34	375	24	6	32	15			
MT21S222		0.9	2	22	243	15	10	32	15			

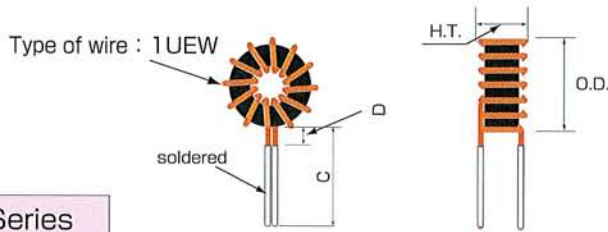

### MT Series

Type No.	Finished Dimensions*4 [mm]			Core Size*5 [mm]			Effective Core Cross Section Ae [mm <sup>2</sup> ]*5	Mean flux Path Length Lm [mm]*5	Total Flux*2 $\phi c$ [ $\mu$ Wb]min	Coercive Force*2 Hc [A/m]	Rectangular Ratio *2 Br/Bm [%]	$\phi c \cdot AW$ [ $\mu$ Wb·mm <sup>2</sup> ]	Insulating Covers*6
	O.D.	I.D.	H.T.	O.D.	I.D.	H.T.							
MT10X7X4.5W	11.5	5.8	6.6	10	7	4.5	5.06	26.7	4.73	20 max	94 min	116	A
MT12X8X4.5W	13.8	6.8	6.6	12	8	4.5	6.75	31.4	6.31				
MT14X8X4.5W	15.8	6.8	6.6	14	8	4.5	10.1	34.6	9.46				
MT15X10X4.5W	16.8	8.8	6.6	15	10	4.5	8.44	39.3	7.88				
MT16X10X6W	17.8	8.3	8.1	16	10	6.0	13.5	40.8	12.6				
MT18X12X4.5W	19.8	10.8	6.6	18	12	4.5	10.1	47.1	9.46				
MT21X14X4.5W	22.8	12.8	6.6	21	14	4.5	11.8	55.0	11.0	1371	A		
MT12X8X3W	13.7	6.4	4.8	12	8	3.0	4.50	31.4	4.20	126	C		
MT15X10X3W	16.7	8.4	4.8	15	10	3.0	5.63	39.3	5.25	277	C		

### MS Series

Type No.	Finished Dimensions*4 [mm]			Core Size*5 [mm]			Effective Core Cross Section Ae [mm <sup>2</sup> ]*5	Mean Flux Path Length Lm [mm]*5	Total Flux*2 $\phi c$ [ $\mu$ Wb]min	Coercive Force*2 Hc [A/m]	Rectangular Ratio *2 Br/Bm [%]	$\phi c \cdot AW$ [ $\mu$ Wb·mm <sup>2</sup> ]	Insulating Covers*6
	O.D.	I.D.	H.T.	O.D.	I.D.	H.T.							
MS7X4X3W	9.1	3.3	4.8	7.5	4.5	3.0	3.38	18.8	3.15	25 max	94 min	23	A
MS10X7X4.5W	11.5	5.8	6.6	10	7	4.5	5.06	26.7	4.73				
MS11X9W	13.8	6.8	6.6	10.7	8.7	4.5	3.38	30.5	3.15				
MS12X8X4.5W	13.8	6.8	6.6	12	8	4.5	6.75	31.4	6.31				
MS14X8X4.5W	15.8	6.8	6.6	14	8	4.5	10.1	34.6	9.46				
MS15X10X4.5W	16.8	8.8	6.6	15	10	4.5	8.44	39.3	7.88				
MS16X10X6W	17.8	8.3	8.1	16	10	6.0	13.5	40.8	12.6	649	B		
MS18X12X4.5W	19.8	10.8	6.6	18	12	4.5	10.1	47.1	9.46	834	A		
MS21X14X4.5W	22.8	12.8	6.6	21	14	4.5	11.8	55.0	11.0	1371	A		
MS12X8X3W	13.7	6.4	4.8	12	8	3.0	4.50	31.4	4.20	126	C		
MS15X10X3W	16.7	8.4	4.8	15	10	3.0	5.63	39.3	5.25	277	C		

\*1 The amount of magnetic flux is equal to (N)  $\times$  ( $\phi c$ ).

\*2 Measuring condition : 100kHz, 80A/m (sine wave), R.T.

\*3 Recommend for designing (note : A design of a transformer in the case may be unable to use this data. Please set up the operating magnetic flux 70% or less of the magnetic flux.)

\*4 Dimensions of the Finished Insulating Covers ; Tolerance :  $\pm 0.2$ mm \*5 Reference value

\*6 Insulating cover is made with UL94V-0 approved material A : Black PET, B : Black PBT, C : Red LCP, D : Natural color PET)

☆ Those other than standard wound articles can be manufactured. Please ask to sales department.  
 ☆ MT sample kits are prepared. Please ask to sales department.

# Merits of the Mag-Amp Method

Since the Mag-amp method uses saturable cores to regulate voltage, there is a big advantage that cannot be achieved by semiconductor-based regulation methods. The advantage is especially clear when there are large changes in the current.

Miniaturization (Downsizing)	Large currents can be handled by small size cores. Also, there is no need for a heat sink and the number of parts for the regulation circuit is small. This results in a smaller mount area compared to semiconductor-based methods.
Power Saving	Because cobalt-based amorphous alloy is used, the operating loss at high frequencies is small. Also, the power needed for control of the Mag-amp is smaller, enabling power to be saved.
Low Noise	The noise from the output diode is small because the Mag-amp is connected in series with the output diode. In semiconductor-based methods, since the number of switching elements increases, so also does the noise.
High Reliability	Since Mag-amps are magnetic parts, the cores are not destroyed by surges in voltage and current. For this reason, they have been used in power supplies requiring reliability, such as those for electricity or large computers.
High Precision	The Mag-amps realize precise output voltage because the secondary side of the main transformer is directly controlled. It is possible to conduct voltage tolerance with high precision ( $\pm 1\%$ ), from no-load conditions to full-load conditions.

As seen above, when the Mag-amp method is used in regulating output voltage of switching power supplies, excellent characteristics can be achieved in size, efficiency, noise, reliability, and precision. Advantages in cost performance are especially realized in low voltage / high current circuits (example: 3.3V-5A).

## Full Mag-Amp Method

The simple Mag-amp method is used mainly for voltage control of the post circuit in power supplies, called the cross-regulation (master-slave) method. This cross-regulation method stabilizes the output voltage by feedback of the main circuit to the primary side. Therefore, the post circuit output is affected by the situation of the load in the main circuit (cross regulation error). There is also the problem that power supplies do not operate unless some current (minimum current) is sent through the main circuit.

The Full Mag-amp method is a way to solve this problem.

The Full Mag-amp method controls each output at the secondary side using the Mag-amp method. Therefore, there is no need for feedback to the primary side, and each output can be controlled from no-load conditions. Also, since each output operates independently, the optimization of the winding ratio for the main transformer can be realized and high efficiency can be realized compared to the cross-regulation method.

Furthermore, since each output is independent in the Full Mag-amp method, it is only necessary to adjust the circuit where specification was changed. Therefore, time can be saved in the process of a design change.

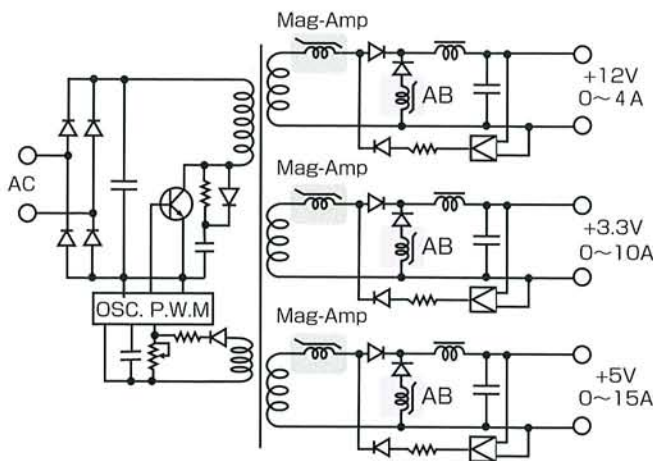

Full Mag-Amp Method

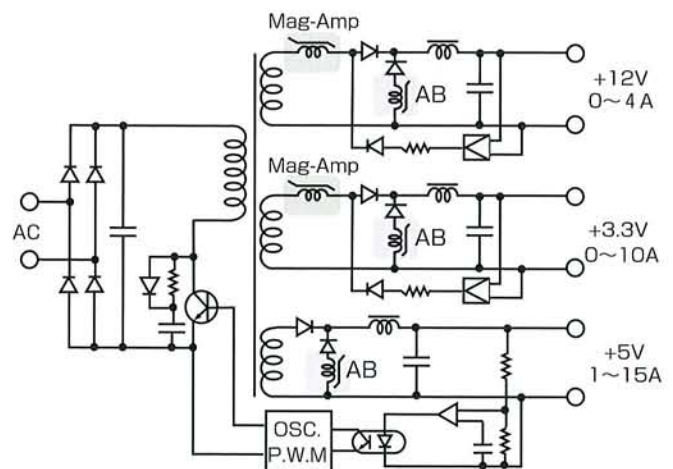

Cross-Regulation (Master-Slave) Method

# Examples of Circuits and Characteristics

## Examples of Circuit

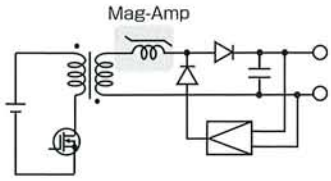

Flyback converter (ON-OFF Type)  
Ringing choke converter (RCC)

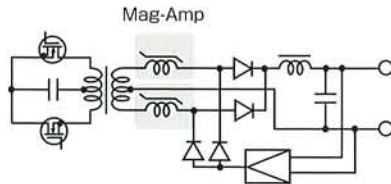

Push-pull converter (Center tap type)

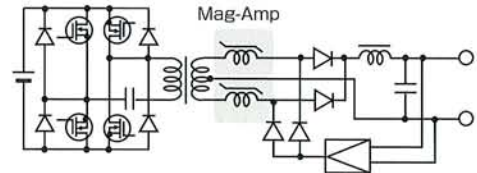

Full bridge converter

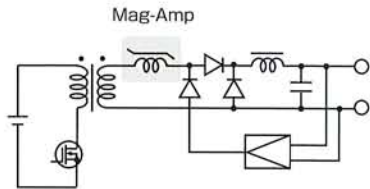

Forward Converter (ON-ON Type)

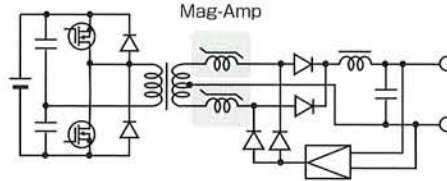

Half Bridge Converter

## Characteristics (Typical Value)

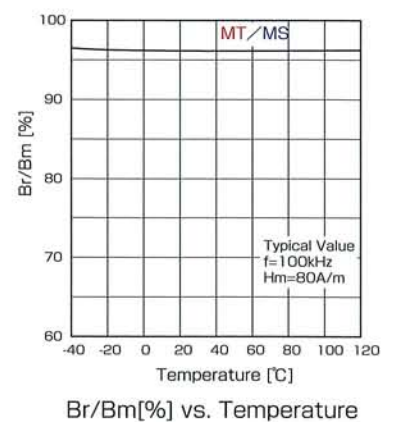
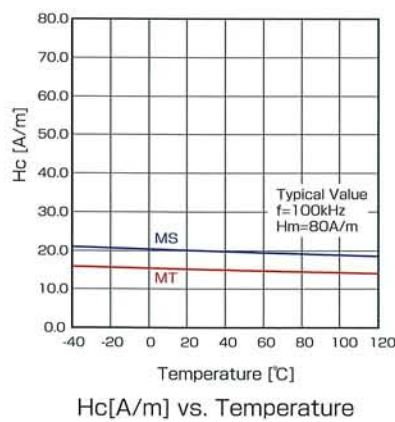
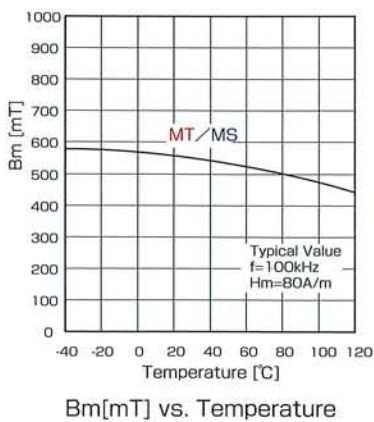
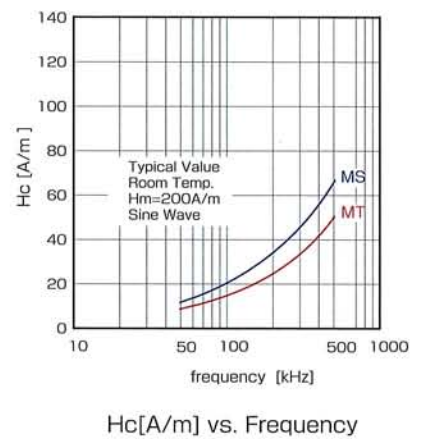
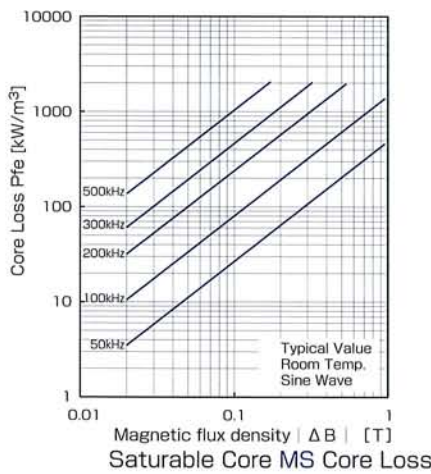
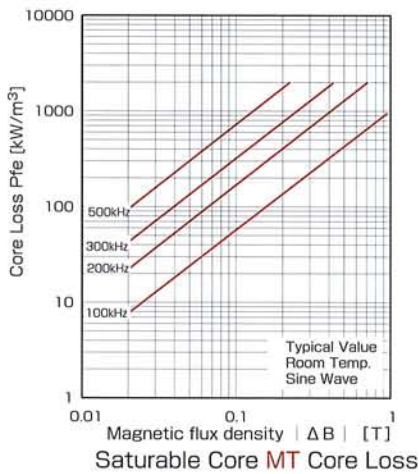

Examples of a use other than Mag-Amp :

Resonancer for Switching Power Supply ( Partial Resonance Element ), CT Magnetic Sensor,  
Transformer Core for Self-Inverter Oscillator, High Frequency Saturable Core for Current Delay or Timing Control

The Mag-Amp method is a switching regulation method for D.C power supply in which the magnetic switch is created through using saturated area and unsaturated area of the saturable core. Voltage regulation at the secondary side of the switching supply is realized by P.W.M. (Pulse Width Modulation).

### Period I (Pulse is on)

When the "ON" pulse is from the main transformer, the flux changes as "I" on the actual magnetization curve. At this time, the saturable core has very high inductance because the core's magnetization is in an unsaturated area. When voltage is added, it is handled at both ends of the coil and the current does not flow toward the side with the current load. During Period "I", the voltage is blocked with the switch OFF, and the pulse width modulation is done.

### Period II (Mag-amp is saturation)

After some time at Period I, the saturable core becomes saturated "II" and the inductance rapidly decreases to a minimum and the current is supplied toward the load side. The switch is ON in Period II.

### Period III (Pulse is off)

When the pulse from the main transformer is OFF (Period III), the magnetic curve of the saturable core changes as in III. It rises over the magnetization axis from the effects of the reverse recovery current and leaked current of the output diode.

### Period IV (Reset)

While the polarity of the pulse voltage is reversed (Period IV), there is voltage control which corresponds with the preset output voltage by the Mag-amp control circuit. The saturable core's magnetization changes (resets) itself as in "IV".

Period I ~Period IV is operated repeatedly through the operated frequency and the voltage is regulated.

The reset area at Period IV and the area at Period I is equal. Therefore, by changing the reset amount at Period IV, the blocked area at Period I can be changed, and it becomes possible to regulate voltage by magnetic P.W.M.

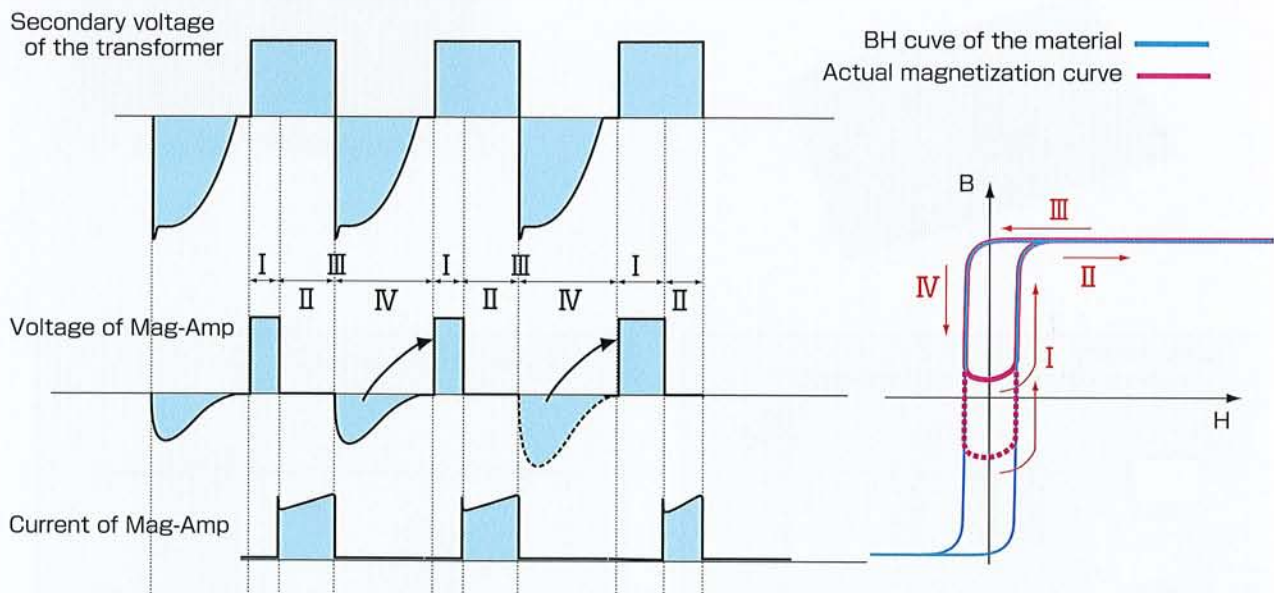

The standard methodology for designing and selecting the proper size mag-amp is to first determine the product of the secondary voltage of the transformer and the "on duty" time, measured in seconds. The proper size mag-amp can then be selected by determining which mag-amp core can adequately handle the highest product of this secondary voltage and "on duty" time, otherwise known as core flux. All calculations must be made on the condition that this on-pulse product of voltage and time is at its maximum.

☆ **On-pulse maximum product of time**

The on-pulse maximum product of time  $\Delta \phi_{v2}$  is calculated from the secondary voltage of the transformer ( $=E2$ ) [V] and the maximum on time duty period ( $=D_{on}$ ) and operating frequency ( $=f$ )[Hz]. For cross-regulation type circuits, the on-duty values for the main circuit at maximum load current are usually used.

$$\Delta \phi_{v2} [\text{Wb}] = E2 \times D_{ON} / f [\text{V} \times \text{Sec}]$$

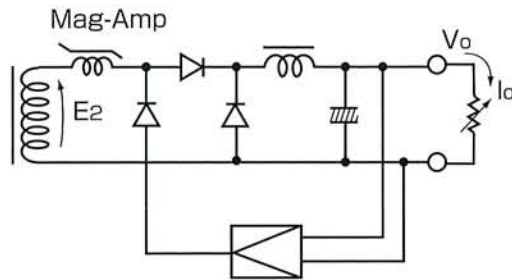

Mag-Amp circuit of the secondary side

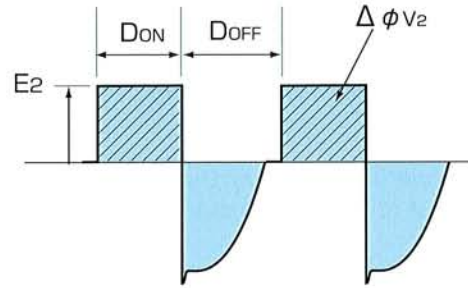

Transformer voltage of the secondary side

☆ **Flux needed for mag-amp control**

The calculation of the Voltage-time product (=Magnetic Flux)  $\Delta \phi_{mag}$  differs between when the mag-amp is used for voltage regulation only and when the mag-amp is also used to protect against over currents.

(1) Voltage regulation

The mag-amp is designed with the standard of no load, because the flux deviation is usually largest when there is no load. The coefficient for the incremental increase in voltage at no load ( $K_v$ ) is used. ( $K_v < 1$ )

$$\Delta \phi_{mag} = \Delta \phi_{v2} \times K_v [\text{Wb}] \quad \left[ K_v = \frac{V_h}{V_o} \text{ see right figure} \right]$$

(2) Protection of over currents

When the mag-amp is also used to protect against over-currents, the on-pulse maximum voltage-time product  $\Delta \phi_{v2}$  must be handled by the mag-amp. Therefore, the following calculation is applied.

$$\Delta \phi_{mag} = \Delta \phi_{v2} [\text{Wb}]$$

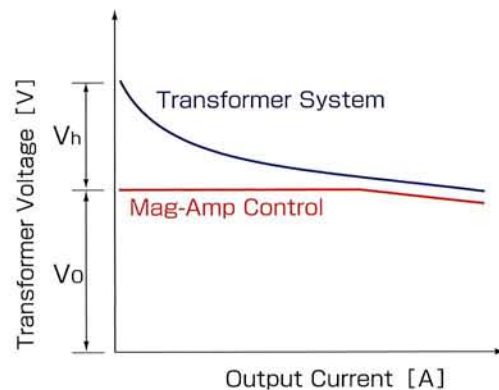

Output Current vs. Transformer Voltage

☆ **Selection of core size**

The core size is selected based on the flux needed to control the mag-amp,  $\Delta \phi_{mag}$ . The following simplified calculation is used to select core size.

$$\phi_c \cdot A_w \geq \Delta \phi_{mag} \times I_o / (K_f \times J) / K_t [\text{Wb} \cdot \text{mm}^2]$$

Here,  $\phi_c$  is the total flux of the core and  $A_w$  is the core winding area. The values for  $\phi_c \cdot A_w$  are found in the standard specification chart.  $K_t$  is the design safety coefficient;  $K_f$  is the coefficient for wire winding, and  $J$  is the current density.

☆ **Calculation of Number of Turn**

The number of turns ( $N$ ) is calculated by the following equation, where  $N$  is an integer.

$$N \geq \Delta \phi_{mag} / \phi_{C \text{ min}} / K_t [\text{turn}]$$

☆ **Calculation of Diameter of the Wire**

From the equation for current density  $J$  [A/mm<sup>2</sup>], wire diameter  $d$  [mm], output current  $I_o$  [A],

$$I_o = (d/2)^2 \times \pi \times J [\text{A}] \rightarrow d = 2 \times \sqrt{I_o / (\pi \times J)} [\text{mm}]$$

Please always confirm operation on the actual circuit after design.

Here, we show a design example when regulating a 5V-10A circuit using a forward converter with an operating frequency of 150kHz.

☆**On-pulse maximum voltage-time product**

The  $E_2$  on the secondary side of the main transformer and the maximum on duty cycle are assumed to be  $E_2=15[V]$  and  $D_{on}=0.4$ .

$$\begin{aligned} \Delta \phi_{v2} &= E_2 \times D_{on} / f \text{ [V} \times \text{Sec]} = \text{[Wb]} \\ &= 15 \times 0.4 / 150000 \\ &= 40 \text{ [}\mu\text{Wb]} \end{aligned}$$

When using a Mag-amp to also protect against over currents,  $\Delta \phi_{mag} = \Delta \phi_{v2}$ . Here, we assume that the mag-amp only regulates voltage and set the incremental increase at the time of no current load as  $K_v=0.6$ .

$$\Delta \phi_{mag} = \Delta \phi_{v2} \times K_v = 40 \times 0.6 = 24 \text{ [}\mu\text{Wb]}$$

☆**Choice of core size**

The wire winding coefficient,  $K_f$ , is the coefficient that it is possible to wind on the inside of a toroidal core. Usually,  $K_f=0.4$  is used. The current density  $J$  is usually set as  $J=5\sim 10[A/mm^2]$ . Here, we assume  $J=8[A/mm^2]$ .

If the mag-amp's maximum operating temperature is assumed to be 120°C, we assume that the flux density of the core decreases to 80%. We also allow flux design space to be 70%.

$$\begin{aligned} \phi_c \cdot A_w &\geq \Delta \phi_{mag} \times I_o / (K_f \times J) / K_t \\ &\geq 24 \times 10 / (0.4 \times 8) / (0.8 \times 0.7) \\ &\geq 133.9 \text{ [}\mu\text{Wb} \cdot \text{mm}^2] \end{aligned}$$

From the standard specification table, MT12X8X4.5W is chosen.

☆**Number of wire winding**

$$\begin{aligned} N &\geq \Delta \phi_{mag} / \phi_{Cmin} / K_t \text{ [turn]} \\ &\geq 24 / 6.31 / (0.8 \times 0.7) = 6.8 \\ &= 7 \text{ [turn]} \end{aligned}$$

☆**Wire diameter**

When the wire diameter is over  $\phi 1.0\text{mm}$ , there is difficulty in the actual wire winding of the toroidal cores. Therefore, when the output current  $I_o$  is over 5[A], parallel winding is used. Here, since  $I_o = 10[A]$ , two parallel wires are used.

$$\begin{aligned} d &= 2 \times \sqrt{I_o / 2 / (\pi \times J)} \text{ [mm]} \\ &= 2 \times \sqrt{10 / 2 / (\pi \times 8)} = 0.89 \text{ [mm]} \end{aligned}$$

As a result, 2 parallel  $\phi 0.9\text{mm}$  wires are wound.

☆**Results of design** (Operating Frequency 150kHz, 5V-10A, Voltage Regulation)

MT12X8X4.5W,  $\phi 0.9\text{mm}$ , 2 parallel windings, 7[turn]

Please always confirm operation on the actual circuit after design. Since the mag-amp is a passive part, it becomes susceptible to effects from the waves of the transformer, and actual operating tests are necessary.

Design Example ( Forward Converter, 150kHz operating)

Current Voltage	Voltage Control (at $K_v=0.6$ )			Over Current Protection (at $E_2 \times D_{on} = 1.2V_o$ )		
	6A ( $\phi 1.0\text{mm}$ )	10A ( $\phi 0.9\text{mm} \times 2\text{p.}$ )	15A ( $\phi 0.9\text{mm} \times 3\text{p.}$ )	6A ( $\phi 1.0\text{mm}$ )	10A ( $\phi 0.9\text{mm} \times 2\text{p.}$ )	15A ( $\phi 0.9\text{mm} \times 3\text{p.}$ )
3.3V	MT12S115	MT12S208	MT12 : 5turn	MT12S115	MT12S208	MT15:7turn
5V	MT12S115	MT12S208	MT15 : 6turn	MT12S115	MT15S214	MT16:6turn
12V	MT15S125	MT15S214	MT18 :11turn	MT15S125	MT18S222	MT21:16turn
15V	MT15S125	MT18S222	MT18 :14turn	MT18S130	MT21S222	MT21:20turn
24V	MT18S130	MT18S222	MT21 :19turn	MT21S134	MT21:32turn	quasi-st'd

Note) Operating flux is influenced by the main transformer of the circuit, and the value shown in the table is not necessarily applied as it is.

## 1) At no-Load

Generally, the range of the flux becomes large at no, or small current load. There is a possibility that the mag-amp may not be able to control the output voltage because there is a shortage of core flux. This problem occurs because the large range of the flux density causes saturating on the other side and there is not enough ability to control the voltage-time product. In order to set the allowances for design, the wire winding for the Mag-amp is reduced and the operating range is confirmed.

However, the core flux necessary at the time of no current load is largely influenced by such factors as the dummy current value. Therefore, when the core flux is large at no current load, such factors as the dummy current value must be adjusted, taking efficiency into account.

## 2) At Full-Load

Generally, the mag-amp's flux range becomes small at the full current load. There is the possibility that output voltage cannot be regulated because it is not possible to make the range any smaller. This problem is called the dead angle.

The allowances for design at full current load are confirmed by increasing the number of wire windings.

However, the dead angle value is influenced not only by the core characteristics, but also by the reverse recovery current of the output diode and leaked currents. Please select output diodes with fast recovery times. Also, when using SBD (Schottky Barrier Diode), please use one with small current leaks and stable temperature characteristics.

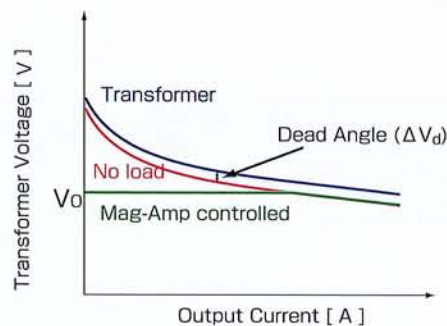

## 3) Temperature Rise

The temperature rise from no current load to full current load should be confirmed. Since the upper limit temperature for continuous use of our mag-amp saturable cores is 120°C, the mag-amp should be designed so that the sum of the surrounding temperature and core temperature rise does not exceed 120°C. Please measure core temperature rise under the condition of natural air-cooling (Without cooling fan). Generally, the mag-amp is designed calculating the temperature rise at  $\Delta T=30^\circ\text{C}\sim 40^\circ\text{C}$ .

With forward converters, the temperature rise at no current load is especially high. When this occurs, the wire winding should be increased and the operating flux density reduced. When the temperature rise is too high at full current load, the wire winding should be reduced and the operating magnetic field reduced.

## 4) Output voltage precision

It is necessary to confirm the voltage regulation characteristics (specifications) from no current load to full current load conditions. When there is a mismatch between the gain of the mag-amp and the gain of the regulated circuit, the circuit vibrates abnormally. Especially when there are sounds from the mag-amp circuit, there is a high possibility that the regulated circuit is abnormally vibrating.

## 5) Protection from Over currents

When protecting for over currents, the range of operating flux for the mag-amp becomes large. Please set the maximum flux range to be 70% of the core flux, similar to when there is no current load.