

SPECIFICATION

- Part No : **ISA.06.A.301111**
- Product Name : 0dBi 400~470MHz UHF Band Low Profile
Adhesive Mount Antenna for Plastic Surfaces
For ISM/ TETRA/CDMA 450/ SCADA
Family Radio Service/General Mobile Radio Service/Bio-Medical
Telemetry
- Features : 239mm x 42mm x 11mm
Robust, Heavy Duty, Semi-Flexible, Low profile
Omni-Directional
Wide-band response from 400Mhz to 470MHz
IP67 Waterproof (Internal PCB)
3M Adhesive for easy mounting
Standard 3 meters RG174 cable
SMA(M) Connector
Cables and Connectors Fully Customizable
RoHS Compliant

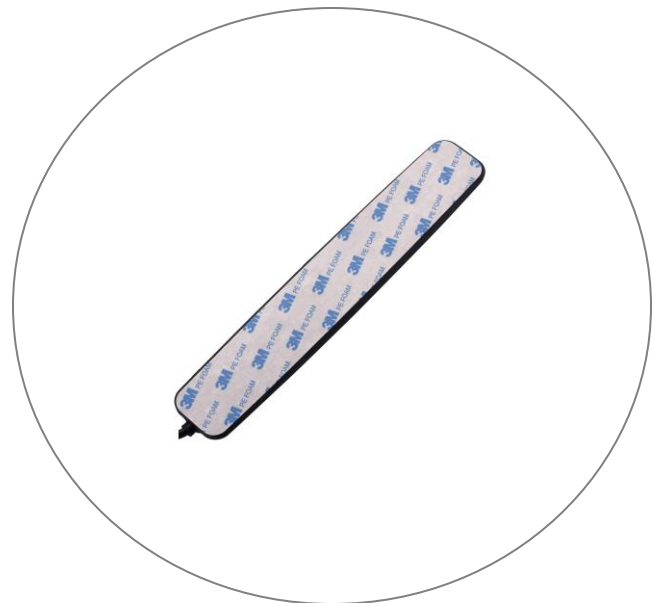

1. INTRODUCTION

The ISA.06 is an omni-directional 400MHz to 470MHz UHF band antenna with IP67 level protection antenna for internal or external applications. The housing is made of robust TPR and can flex up to 20 degrees to fit curved surfaces.

Unlike our competitors, Taoglas shows full performance data for our antennas. The ISA.06 shows real gain figures and radiation patterns INCLUDING cable losses, tested in state of the art low frequency anechoic chambers. We have invested heavily in research to create a uniquely wide-band UHF antenna with minimum 70MHz bandwidth that can replace expensive externally mounted antenna solutions. The wide-band compared to other narrow-band 20MHz antennas delivers more stable performance in more environments with more resistance to detuning. All low frequency UHF antennas need to be tuned to suit their mounting environment. For this reason this antenna is tuned to be mounted on plastic surfaces (i.e. excluding metal or glass mounting), so is ideal for covert non-obtrusive placement in vehicles. For glass-mount applications please use ISA.01.

Typical applications are in law enforcement (Tetra and public safety), remote telemetry, public transportation, mining,

At only 10.5mm thick and 42mm in width, its semi-flexible properties and strong 3M automotive approved double-sided adhesive allows for convenient installation. The standard cable is 3 meters RG174 coaxial cable.

Cable length and connector type are fully customizable

The ISA.06 can be customized for other low frequency bands for a minimum order quantity. Please contact your local Taoglas sales office.

2. SPECIFICATION

ISM						
Frequency		410	433	450	470	MHz
Peak Gain	Cable 1m	2.0	0.1	-1.5	-1.0	dBi
	Cable 2m	1.2	-2.3	-2.5	-1.8	dBi
	Cable 3m	0.5	1.5	0.8	-0.2	dBi
Average Gain *		-5.0	-3.5	-4.5	-4.8	dBi
Efficiency *		30	45	35	33	%
Return Loss *		-9.0	<-15.0	-9.0	-7.0	dB
Polarization	Linear					
Impedance	50					Ω
MECHANICAL						
Antenna Dimensions	239mm x 42mm x 10.5mm					
Cable	3M RG174 standard, customizable cable length					
Connector	SMA (M) standard, fully customizable					
Casing	TPR					
Waterproof	Outside Casing - IP65 Internal PCB Antenna - IP67					
ENVIRONMENTAL						
Operation Temperature	-40°C ~ +85°C					
Storage Temperature	-40°C ~ +85°C					

*** All measurements were conducted with 3m RG174 cable**

3. TEST SET UP

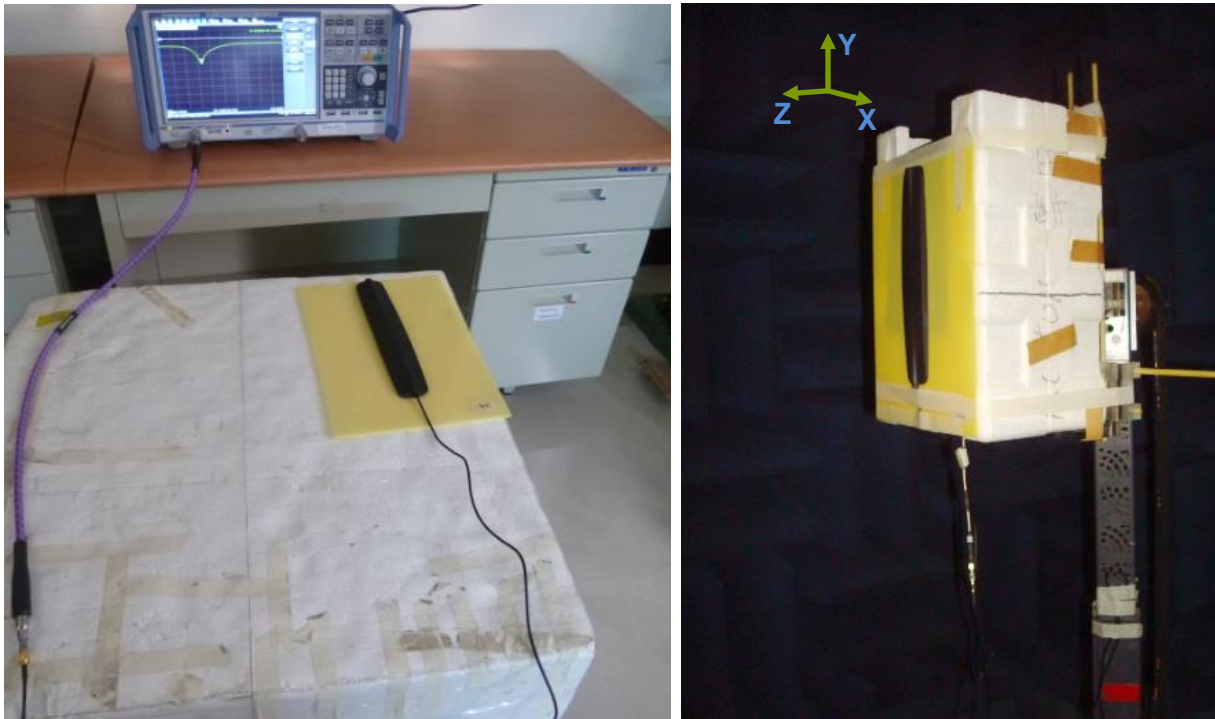

Figure 1. Impedance measurements (left hand) and peak gain, efficiency and radiation pattern measurements (right hand).

4. ANTENNA PARAMETERS

4.1. Return Loss

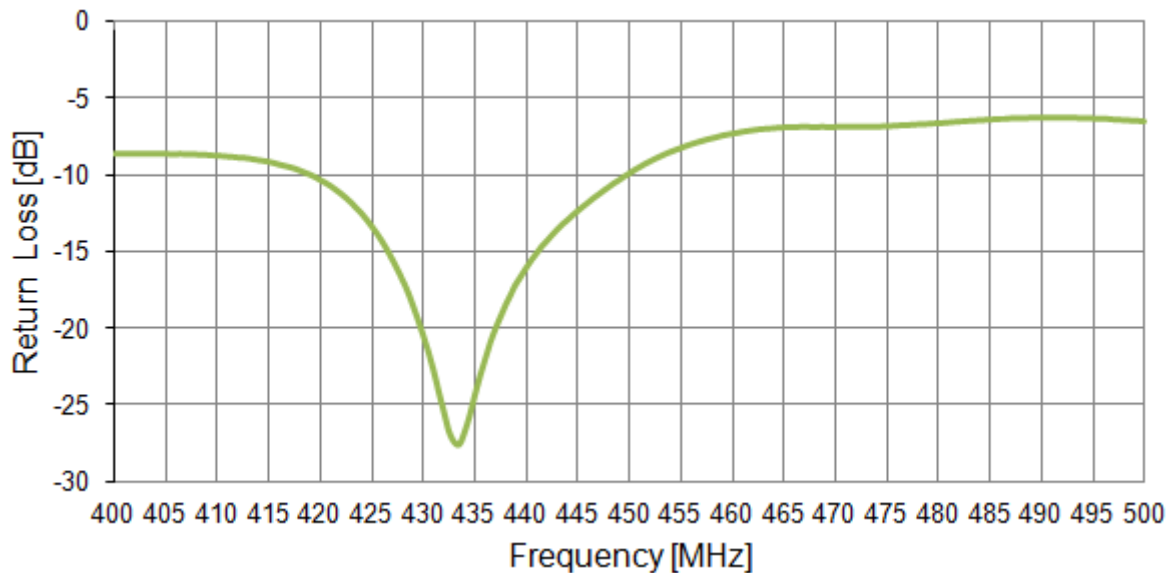

Figure 2. Return loss of the ISA.06 Antenna.

4.2. VSWR

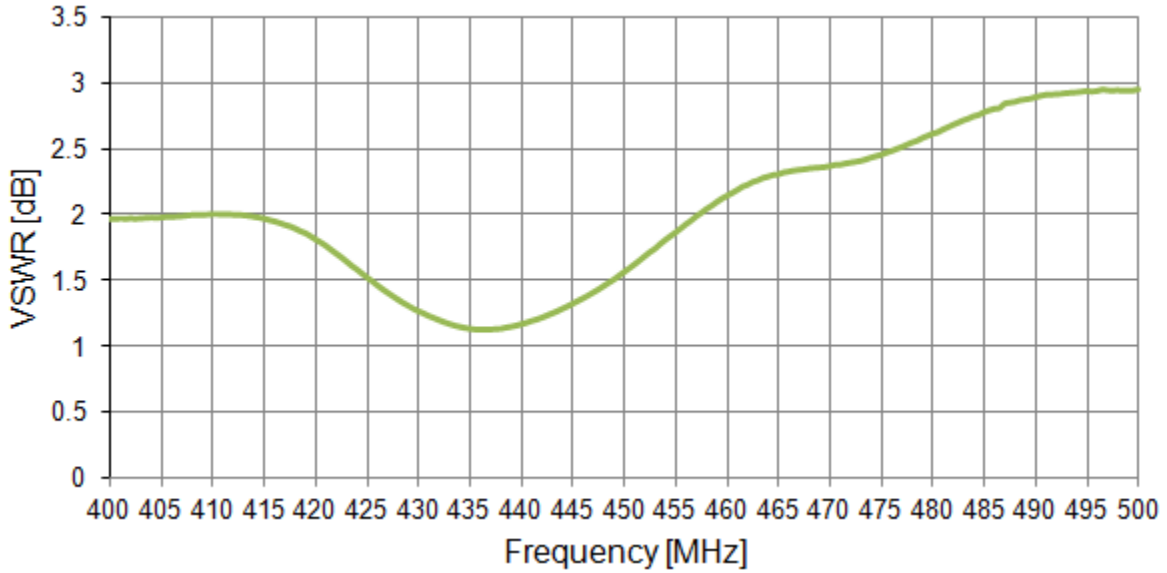

Figure 3. VSWR of the ISA.06 Antenna.

4.3. Efficiency

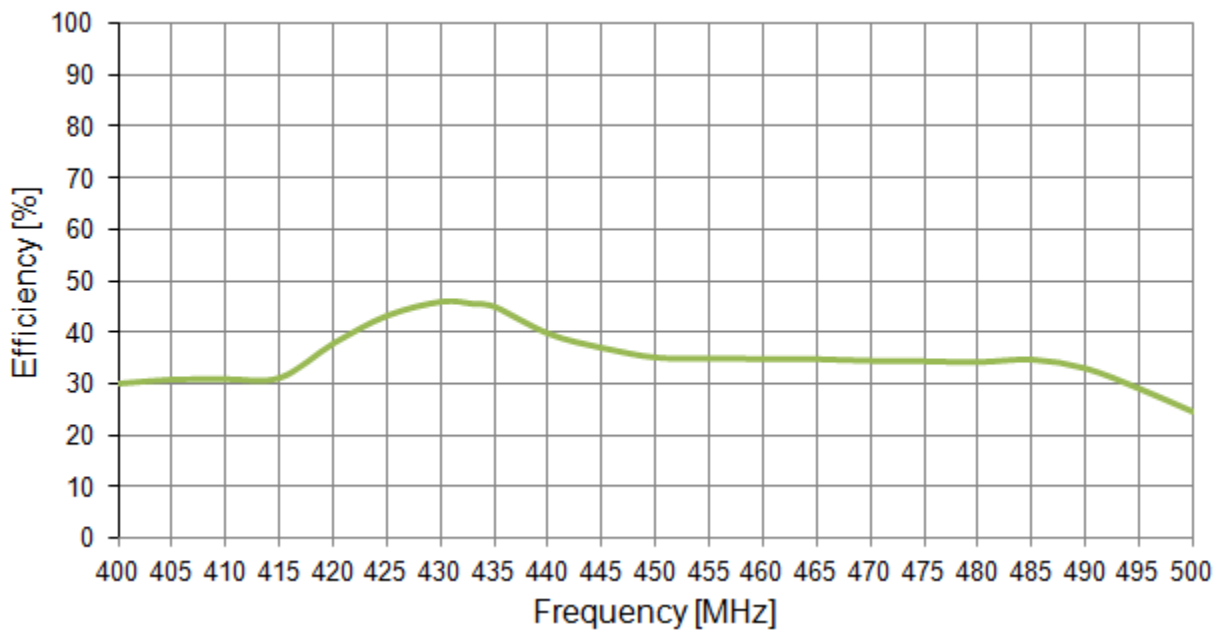

Figure 4. Efficiency of the ISA.06 Antenna.

4.4. Peak Gain

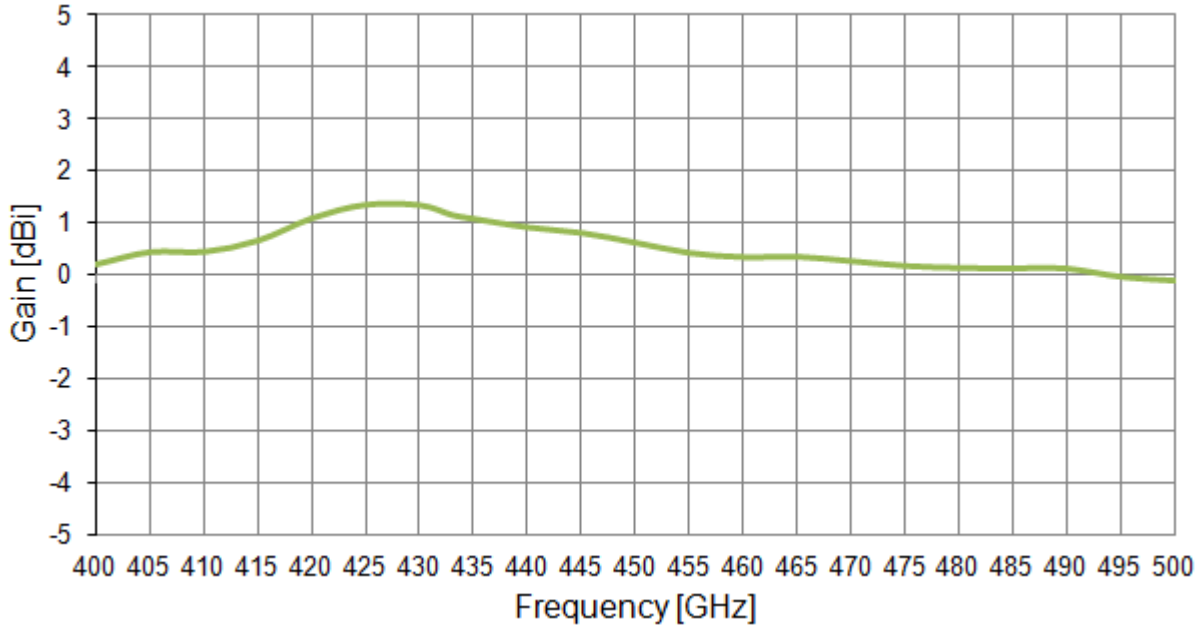

Figure 5. Peak Gain of the ISA.06 Antenna.

4.5. Average Gain

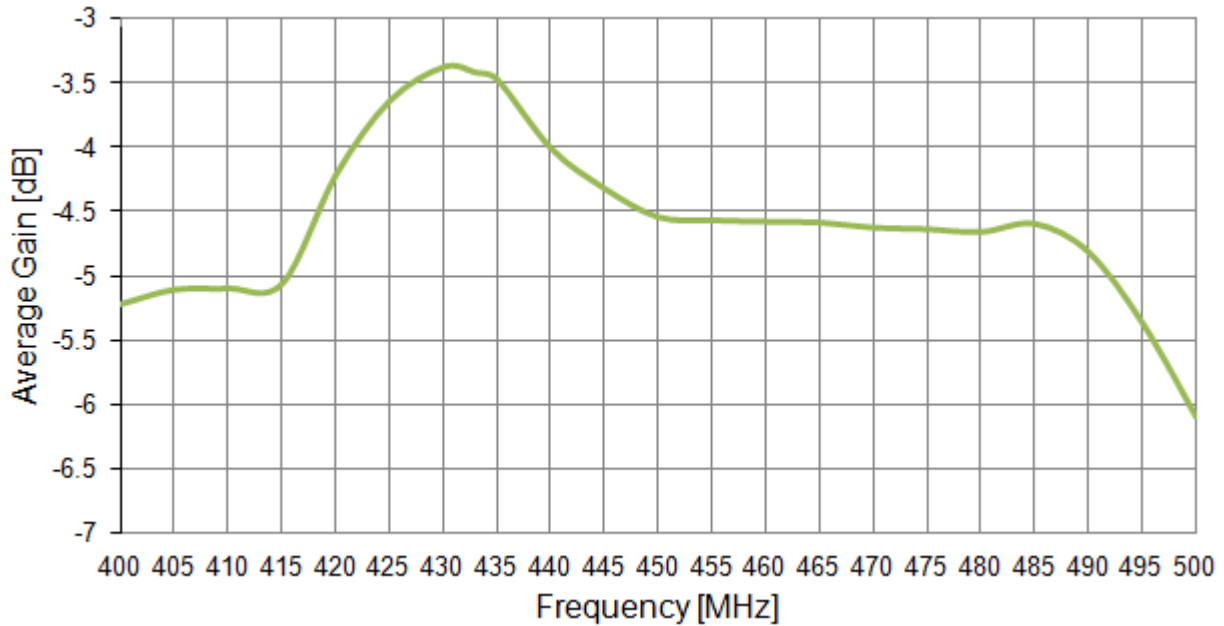

Figure 6. Average Gain of the ISA.06 Antenna.

4.6. Radiation Pattern

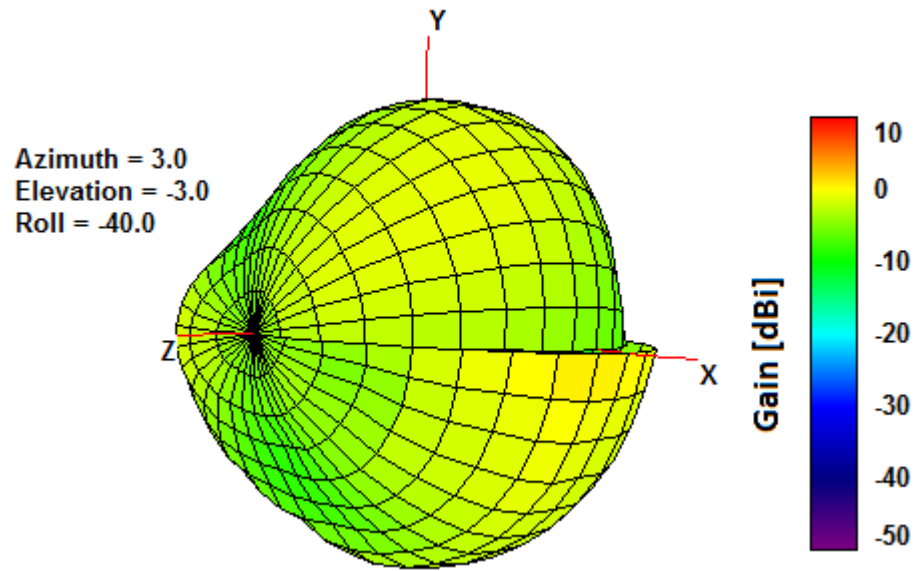
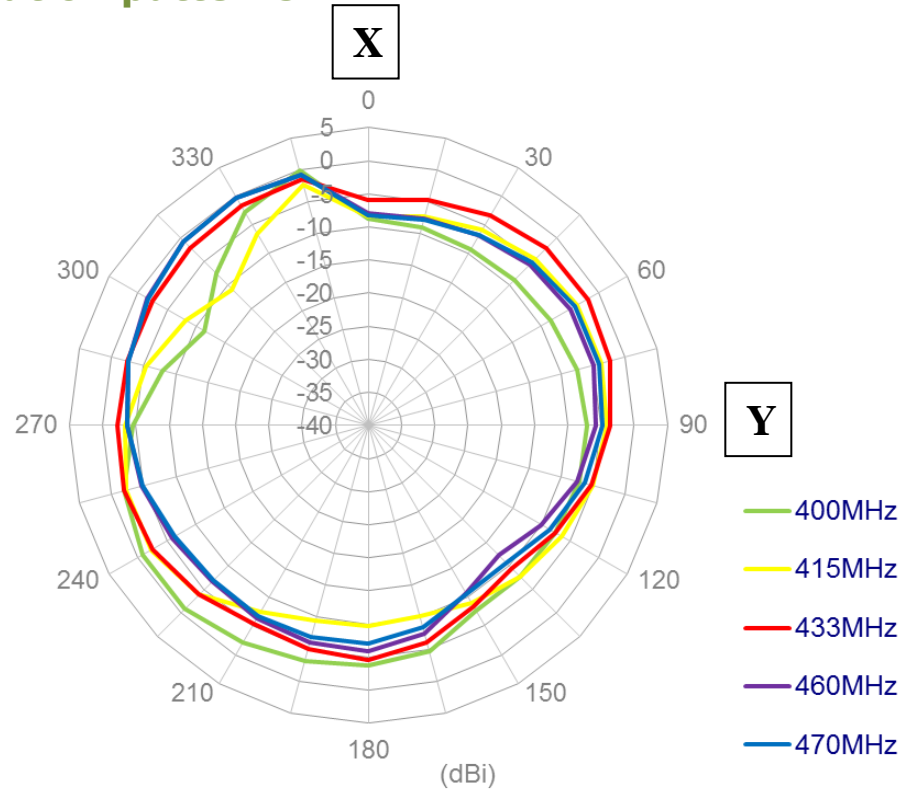

Figure 7. Radiation Pattern at 433 MHz of the ISA.06 Antenna.

4.7. 2D Radiation patterns



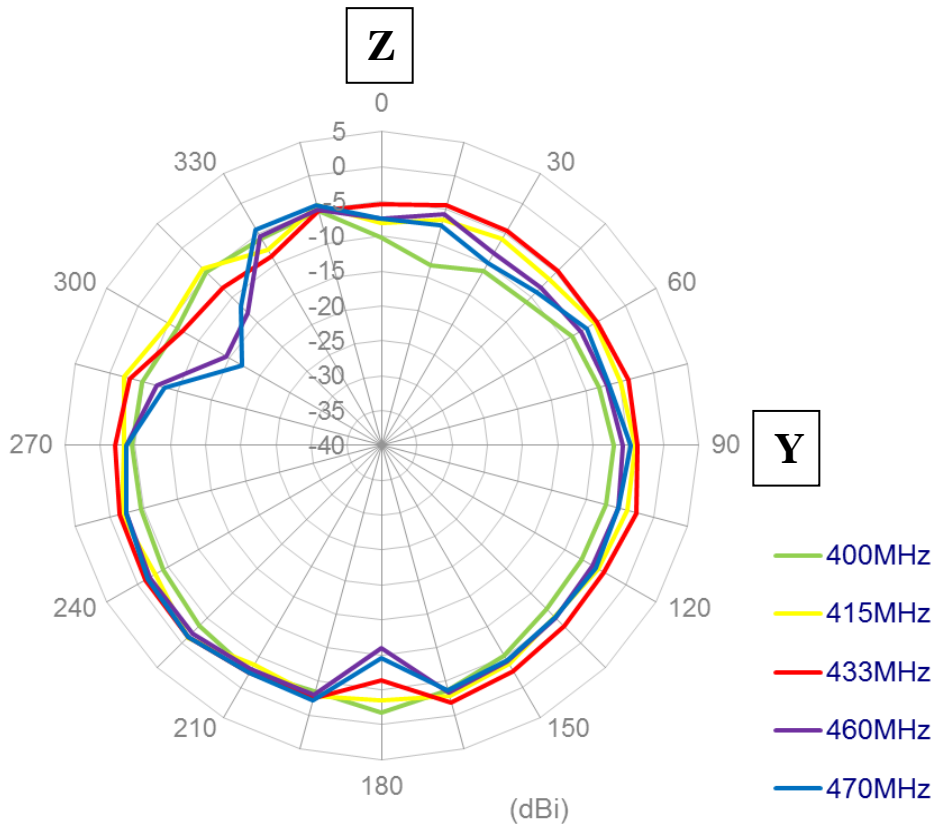
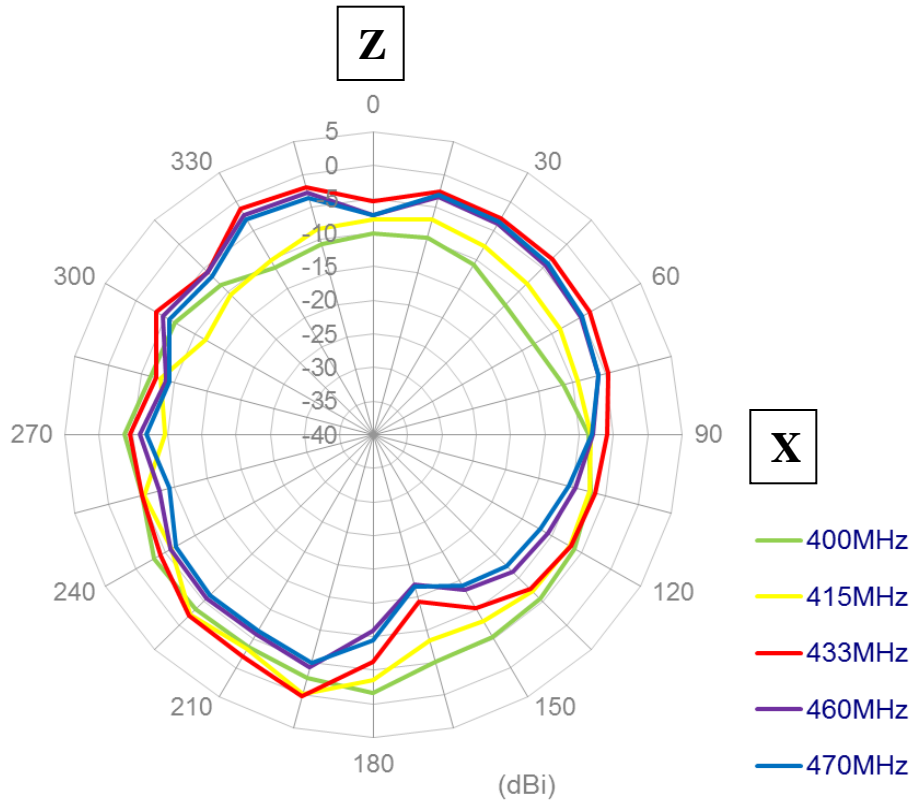
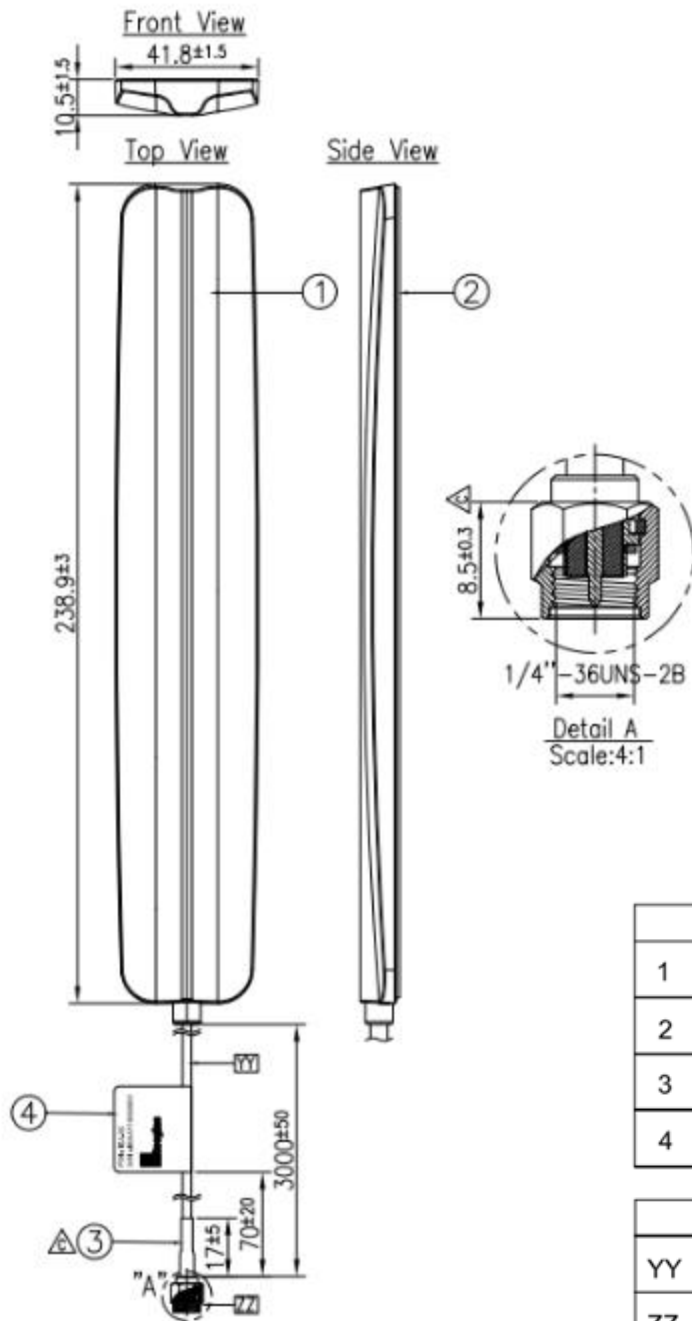

Figure 8. 2D Radiation Pattern of the ISA.06 Antenna.

5. MECHANICAL Drawing



	Name	Material	Finish	QTY
1	Housing-Top	TPR	Black	1
2	3M Double Side Adhesive	3M 1600T 1t	Gray	1
3	Heat Shrink Tube	PE	Black	1
4	ISA.06 Label	Gloss Silver PET	Silver	1

	Name	Spec	Finish	QTY
YY	Cable Type	RG174	Black	1
ZZ	Connector Type	SMA(M) ST	Gold	1

Figure 9. Antenna dimensions of the ISA.06 Antenna.

6. APPLICATION NOTE

Return loss of antenna with 1M and 2M cable lengths

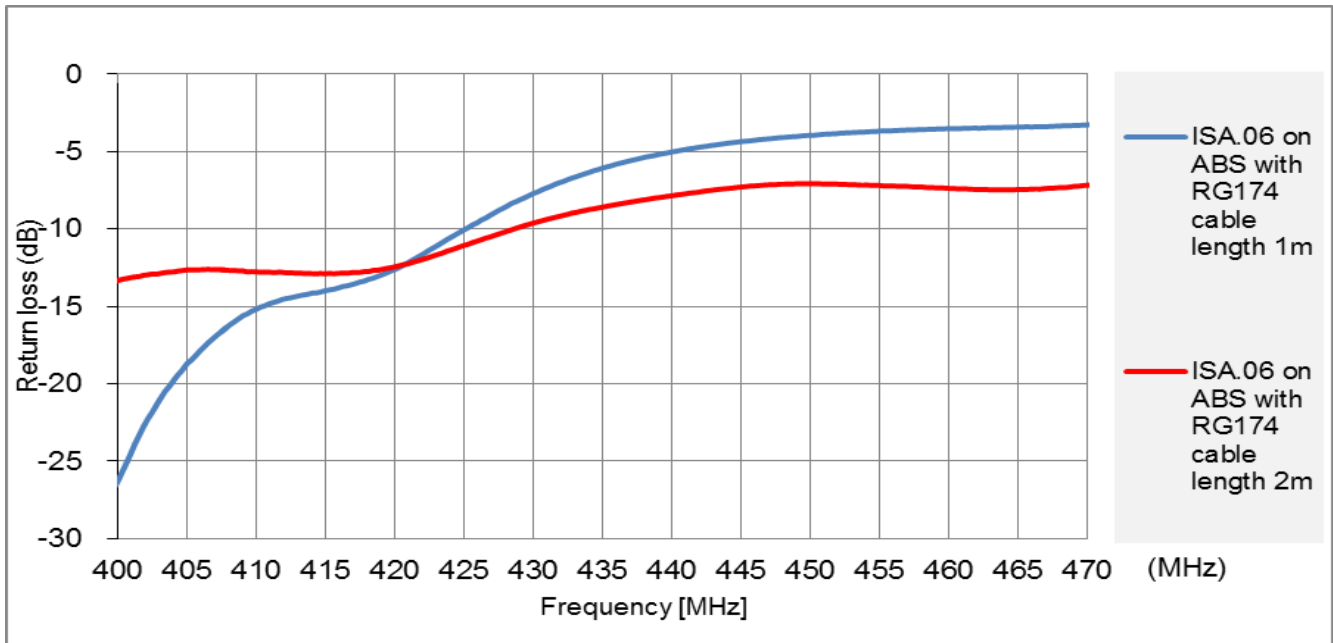

Figure 10. The return loss of ISA.06 antenna with different cable length.

Antenna efficiency with 1M and 2M cable lengths

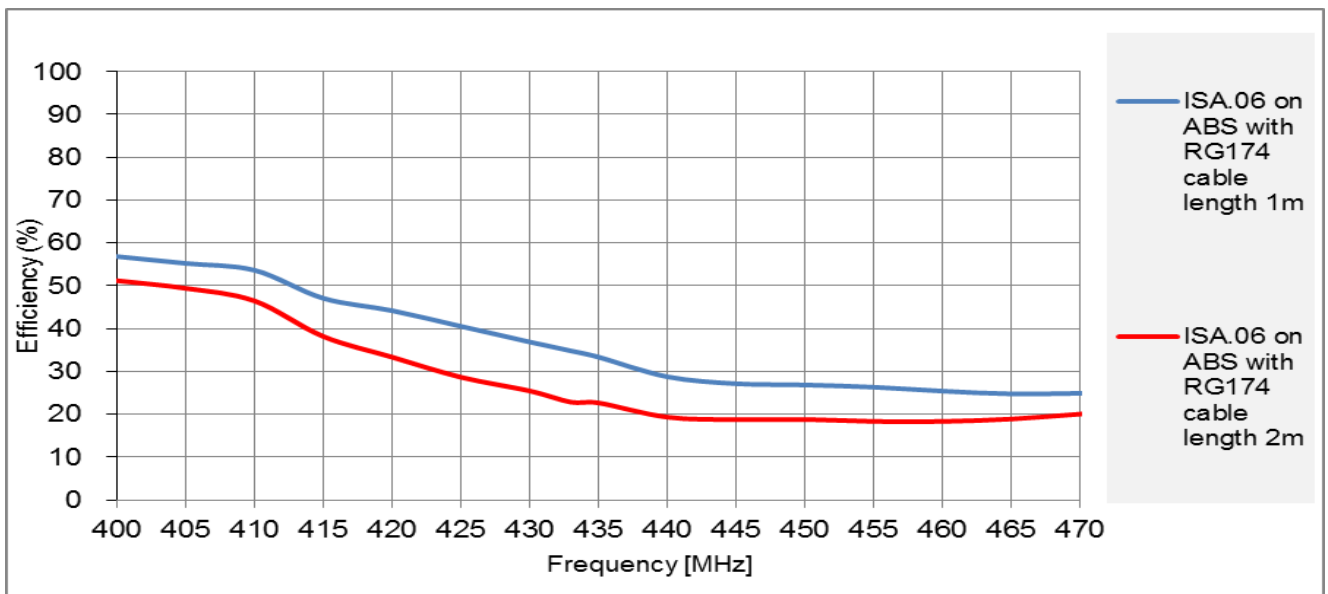

Figure 11. The efficiency of ISA.06 antenna with different cable length.