

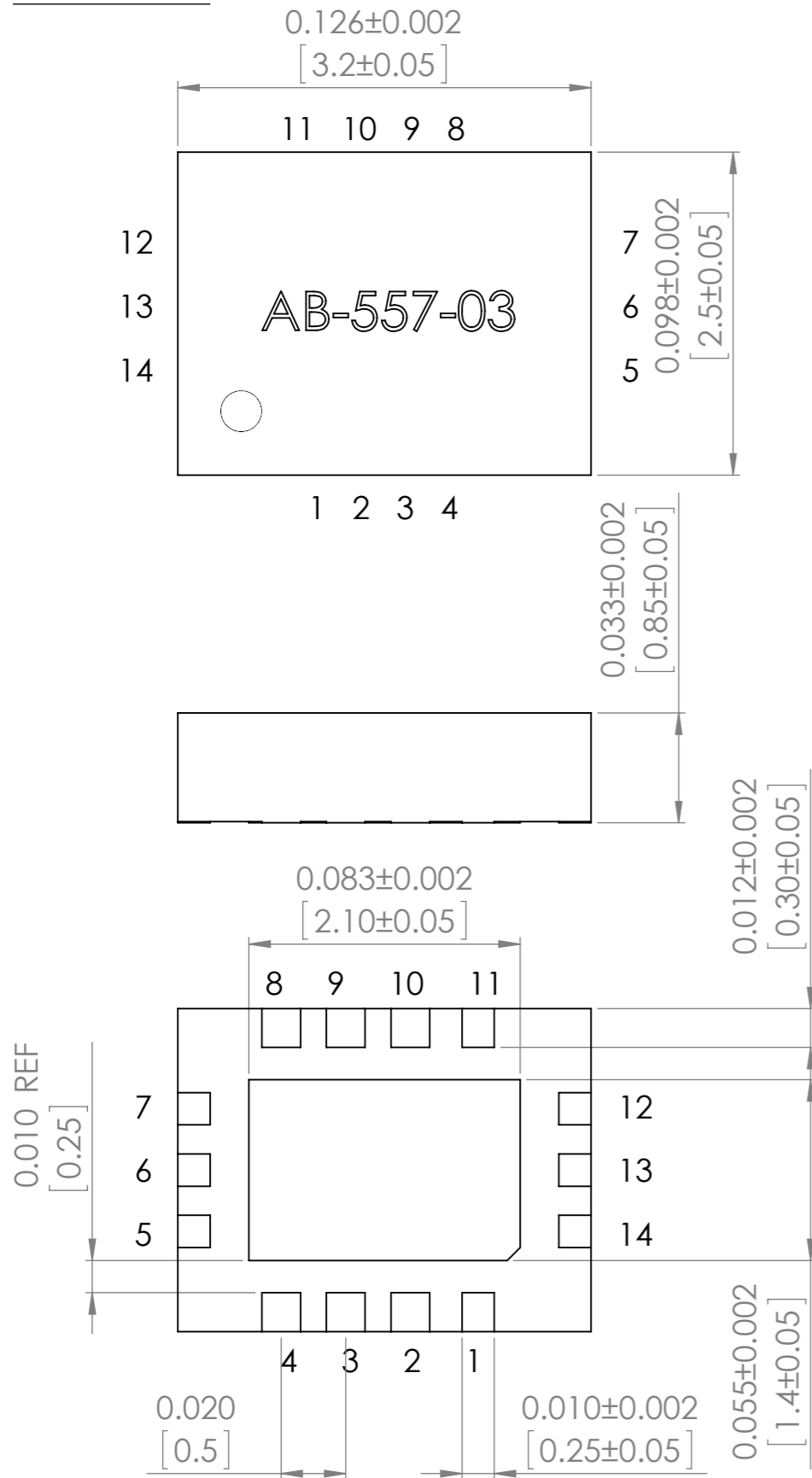

14 Pin QFN:

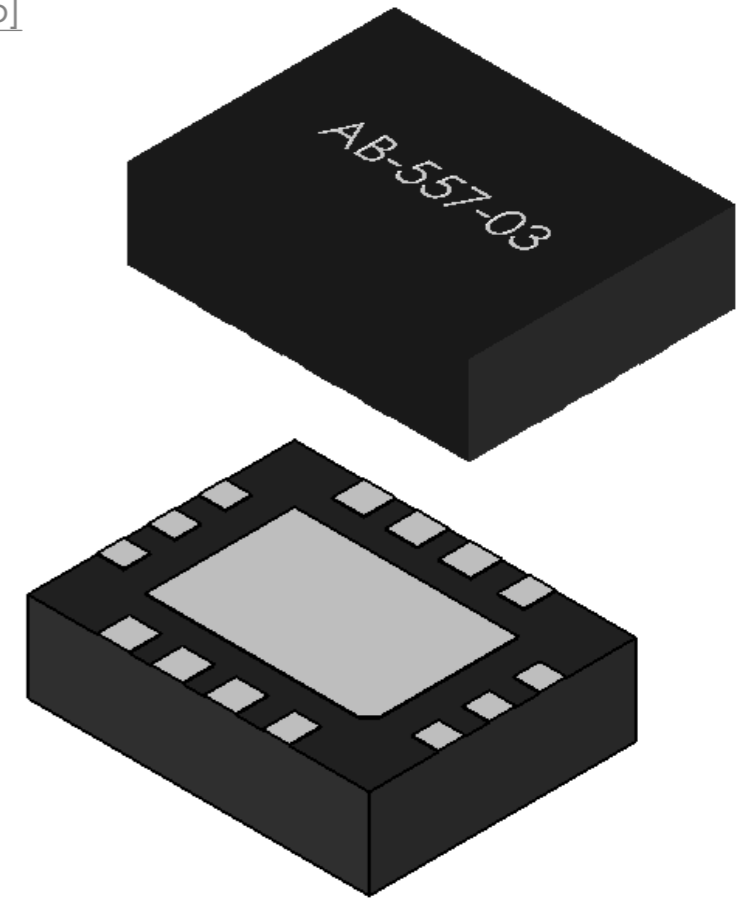
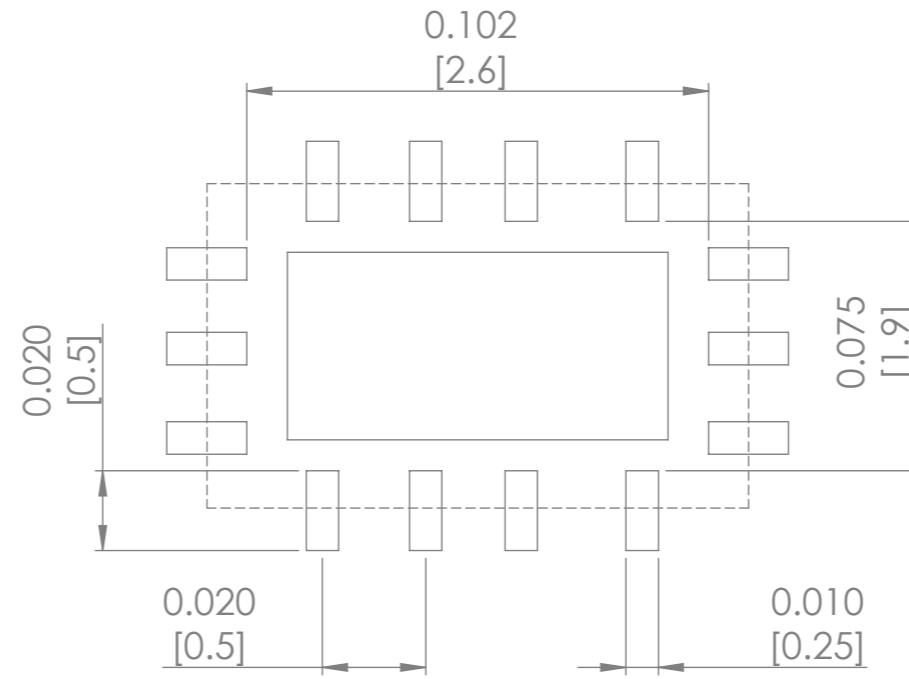

Center pad: NC/GND

Recommended Solder pad layout



UNLESS OTHERWISE SPECIFIED: DIMENSIONS ARE IN MM SURFACE FINISH: TOLERANCES: LINEAR: ANGULAR:				FINISH:		DEBUR AND BREAK SHARP EDGES		DO NOT SCALE DRAWING		REVISION -	
DRAWN SAAZVAT				SIGNATURE		DATE		 30332 Esperanza, Rancho Santa margarita, California 92688			
CHK'D XXXXXX								TITLE: Oscillator			
APPV'D								DWG NO. AB-557-03		A3	
MFG								SCALE: 4:1		SHEET 1 OF 2	
Q.A						MATERIAL:					
						WEIGHT:					

16 Pin TSSOP:

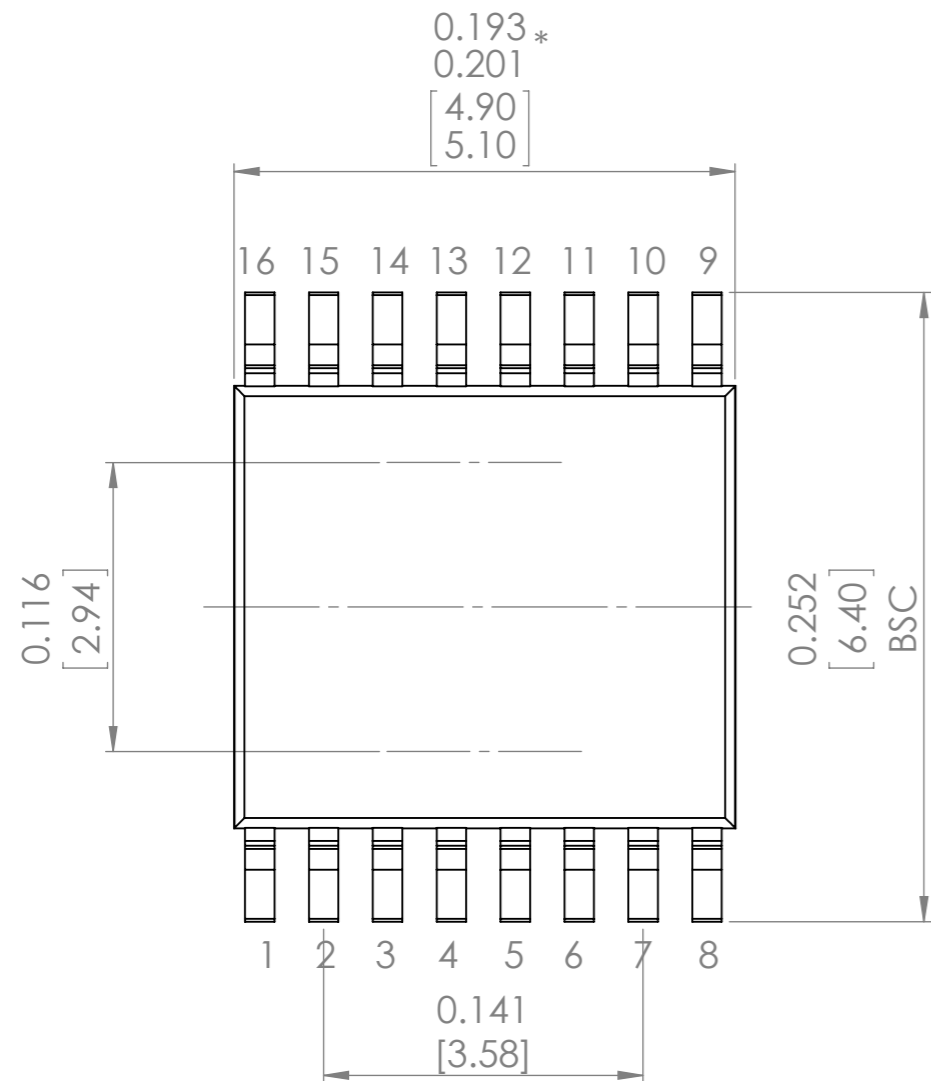
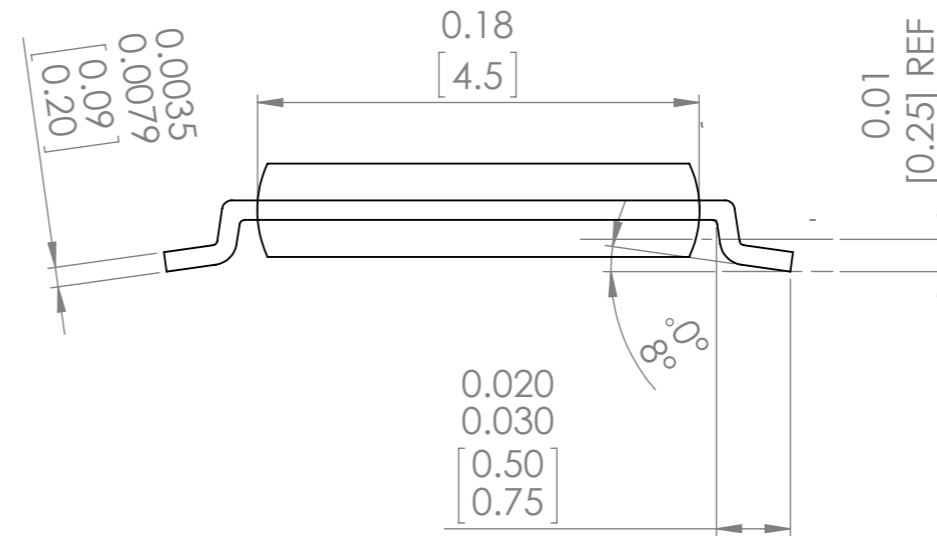
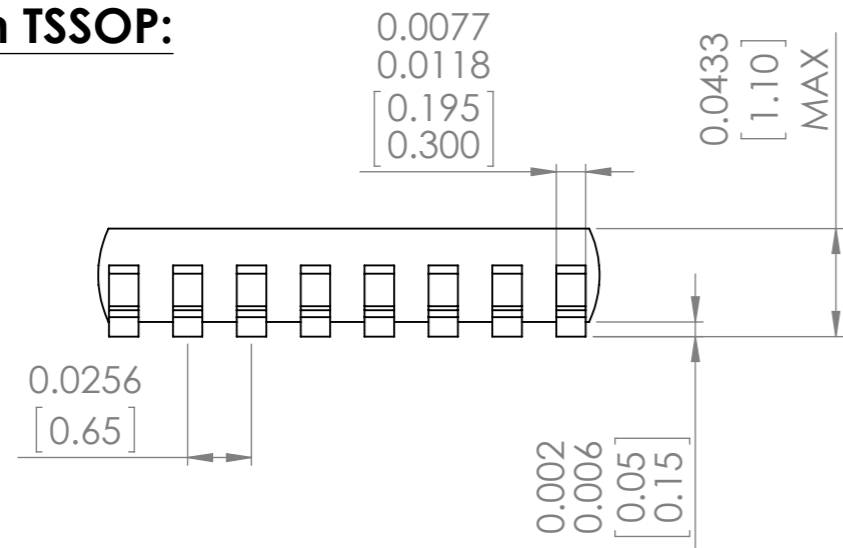

Recommended Solder pad layout

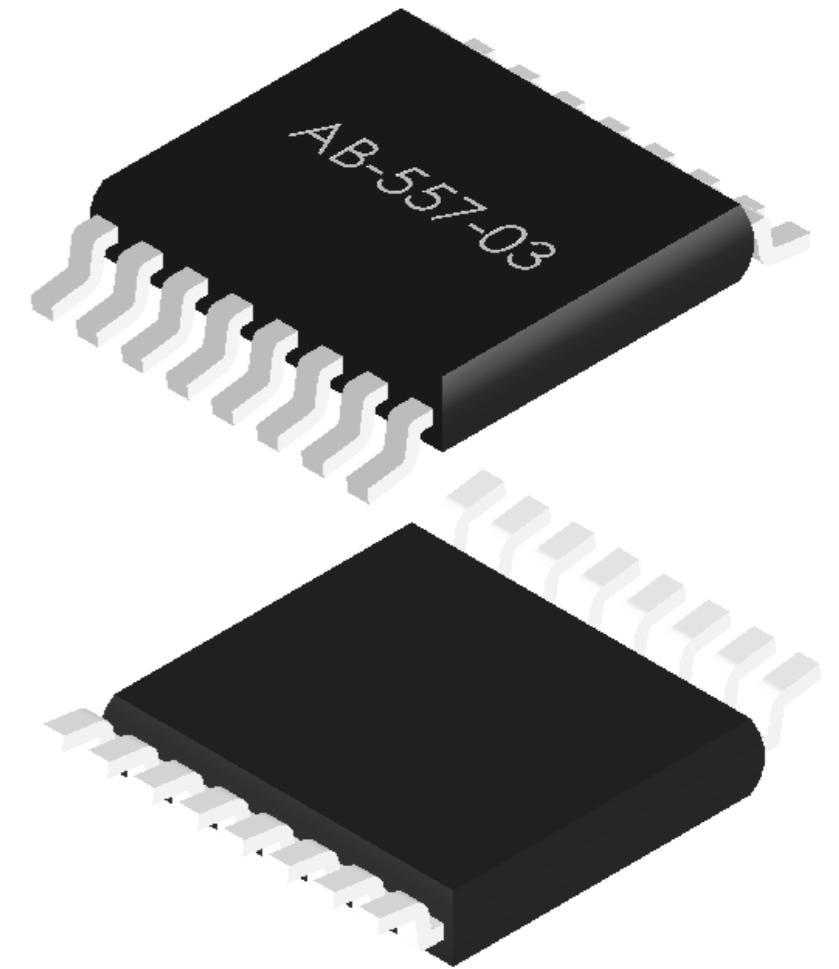
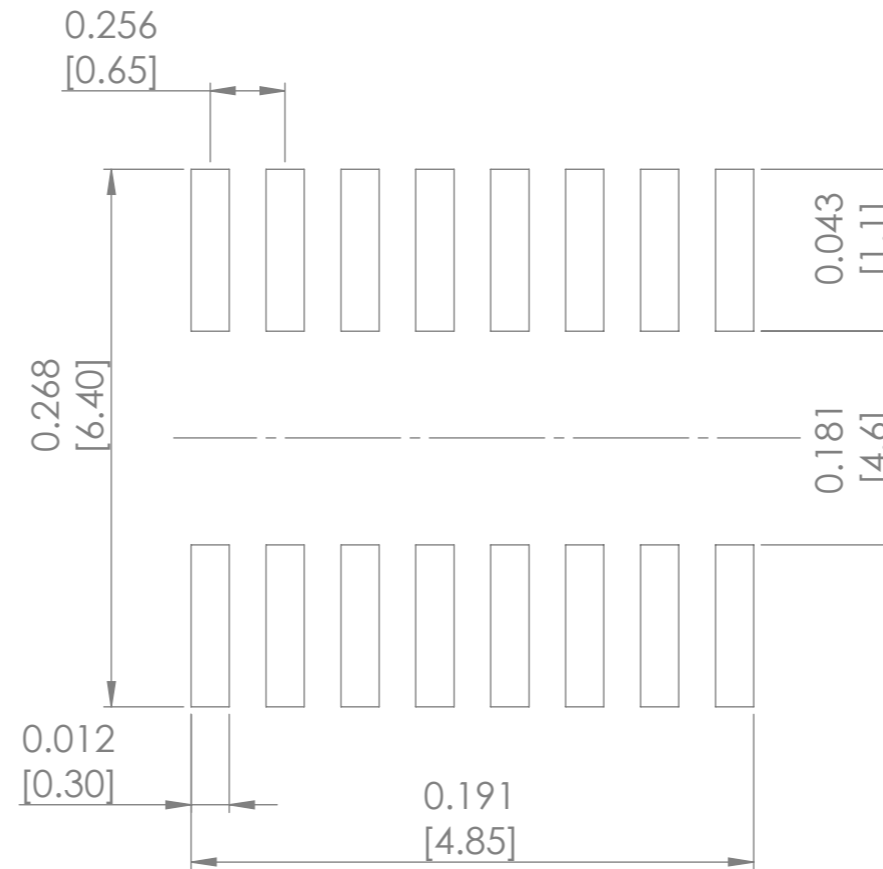

* Dimensions do not include mold flash. Mold flash shall not exceed 0.150mm(.006 inches) per side.

UNLESS OTHERWISE SPECIFIED: DIMENSIONS ARE IN MM SURFACE FINISH: TOLERANCES: LINEAR: ANGULAR:				FINISH:		DEBUR AND BREAK SHARP EDGES		DO NOT SCALE DRAWING		REVISION	
DRAWN SAAZVAT				SIGNATURE		DATE		 30332 Esperanza, Rancho Santa margarita, California 92688			
CHK'D XXXXXX								TITLE: Oscillator			
APPV'D								DWG NO. AB-557-03			
MFG								SCALE:13:1			
Q.A						MATERIAL:		SHEET 2 OF 2			
						WEIGHT:		A3			