



Expertise Applied | Answers Delivered



IMPROVE SAFETY
AND RELIABILITY
WITH INSTANT
ARC-FLASH
DETECTION



OVER 18,000 LITTELFUSE ARC-FLASH
RELAYS INSTALLED WORLDWIDE

“Had this relay not been there, they were looking at \$800,000 to \$1 million of cost...”

—Tim Deschamp, Evans Enterprises, USA

Littelfuse Arc-Flash Relay Saves Plant from Catastrophic Damage

Tim Deschamp from Evans Enterprises was working with a customer to help them resolve a critical issue with an electrical hazard in their furnace control room. An earlier arc-flash analysis had determined that one 480-volt cabinet, which was fed from a 3500 kVA transformer, exceeded an arc-flash PPE Category 4 (PPE 4).

To be able to work on the cabinet or lower required PPE, Deschamp needed to lower the PPE. He selected the PGR-8800 Arc-Flash Relay from Littelfuse, which could be easily retrofitted into the existing cabinet and didn't have the maintenance problems that he had experienced with other relay manufacturers. After the relay was installed, an engineering firm recalculated the cabinet's arc-flash category from PPE 4 to a PPE 2, a level easily approachable using 8 cal/cm² PPE.



\$1 Million Savings

Just one week after the PGR-8800 was installed, the plant experienced an arc-flash incident. “Had this relay not been there, they were looking at between \$800,000 and \$1 million of cost, considering downtime and equipment replacement,” Deschamp said. “Besides the lead-time for delivery and the installation, they would have had to cut a hole in the outside wall of the plant to install it.” Instead, the entire cost to the end-user was only \$6,000, which included replacing a few insulators and a portion of the bus bar. The plant was back up and running within 24 hours. Immediately after the incident, the customer requested that Deschamp install Littelfuse PGR-8800 Arc-Flash relays in all of their larger electrical cabinets.

Summary

This is an example of how a minimal investment of just a few thousand dollars can save tremendous costs in lost equipment, downtime and production, not to mention the risk of employee injury or fatality. This customer was fortunate with his timing, but a proactive strategy is recommended when it comes to protecting critical assets and employee safety. An arc-flash relay is an integral component of an arc-flash protection scheme that can minimize damage and save money, time and lives.

To read the full story and for more information on the PGR-8800 Arc-Flash Relay, visit Littelfuse.com/ArcFlash.

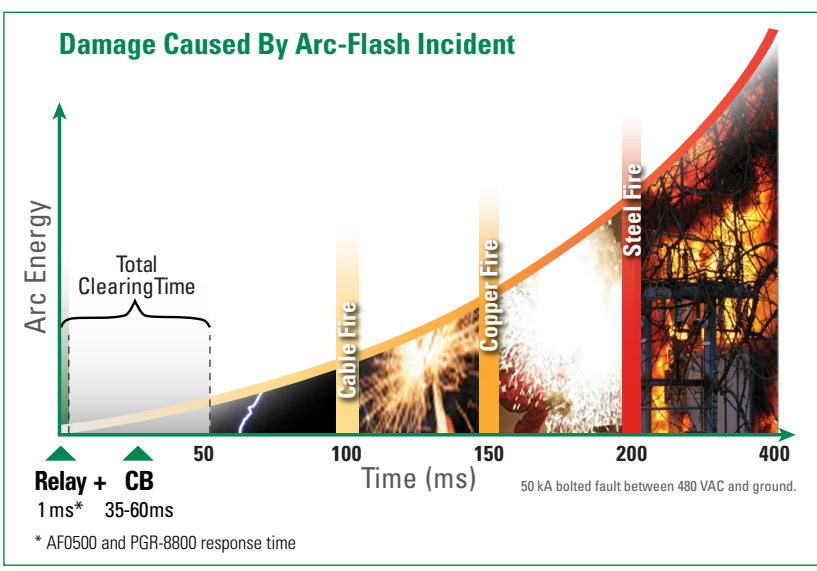

The Littelfuse Arc-Flash Relays use a 125- μ s light-sampling scheme in combination with an ultra-fast IGBT output to be able to detect a developing arc flash and send a trip signal to a circuit breaker in milliseconds.

Fast Arc-Flash Detection in Less Than 1 ms

Minimize Damage. Circuit breakers (CBs) or overcurrent protection devices (OCPDs) alone do not provide optimal protection for your personnel and equipment. The Littelfuse Arc-Flash Relays rapidly detect an arc flash and send a trip signal to interrupt power.

PGR-8800 Arc-Flash Relay

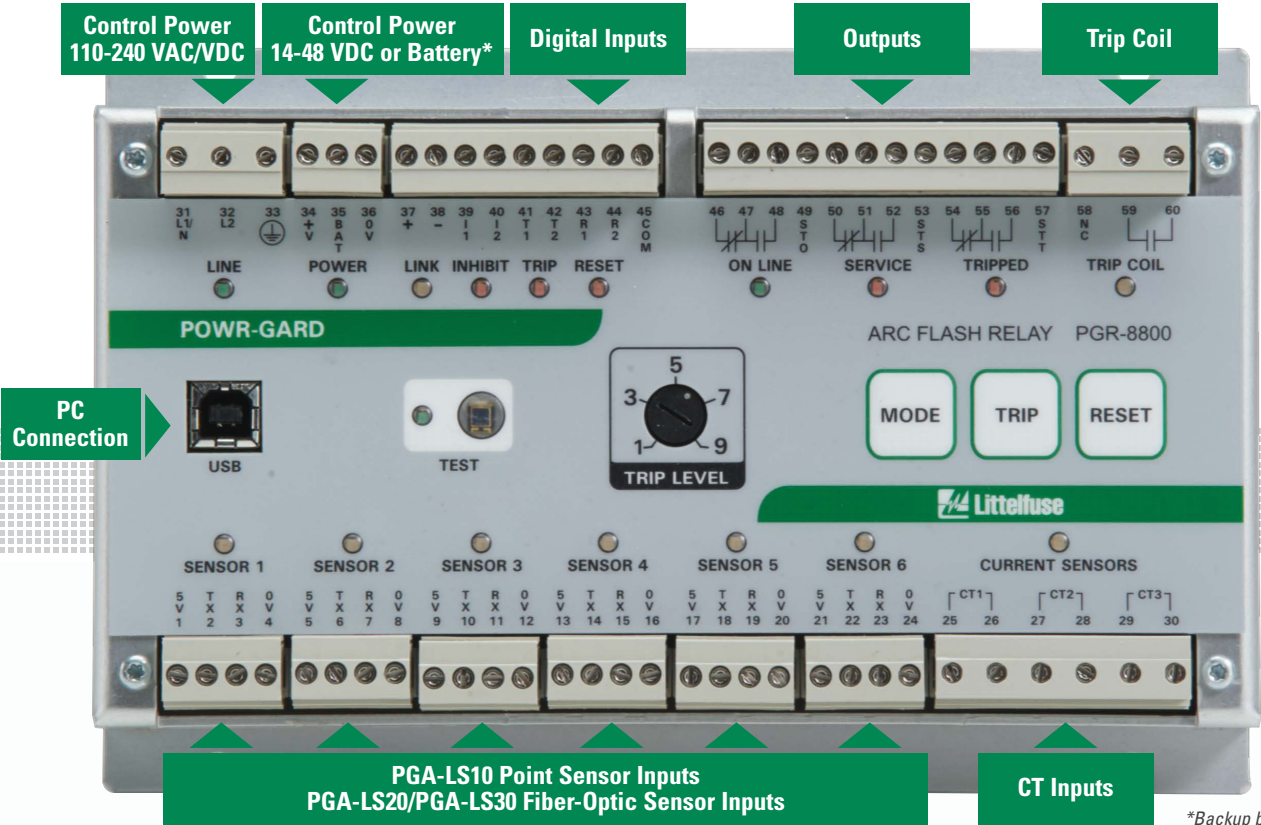

**Backup battery not included*

Simple Plug & Play Installation and Maintenance

The Littelfuse Arc-Flash Relays and sensors are easily retrofitted into existing switchgear or pre-installed in new equipment with little or no configuration. Even elaborate systems only take minutes to configure using the relays' built-in USB interface software, and the innovative digital inputs/outputs on the AF0500 and AF0100 (pages 4 & 5).

- Improve sustainability and life of electrical equipment
- Lower the PPE Category of the equipment
- Provide protection against equipment damage and potential injury to personnel or incident energy
- Easily installed without changes to existing layout
- Flexible sensor configuration for any application
- No additional software is required

Industry Leading Arc-Flash

AF0500 Arc-Flash Relay

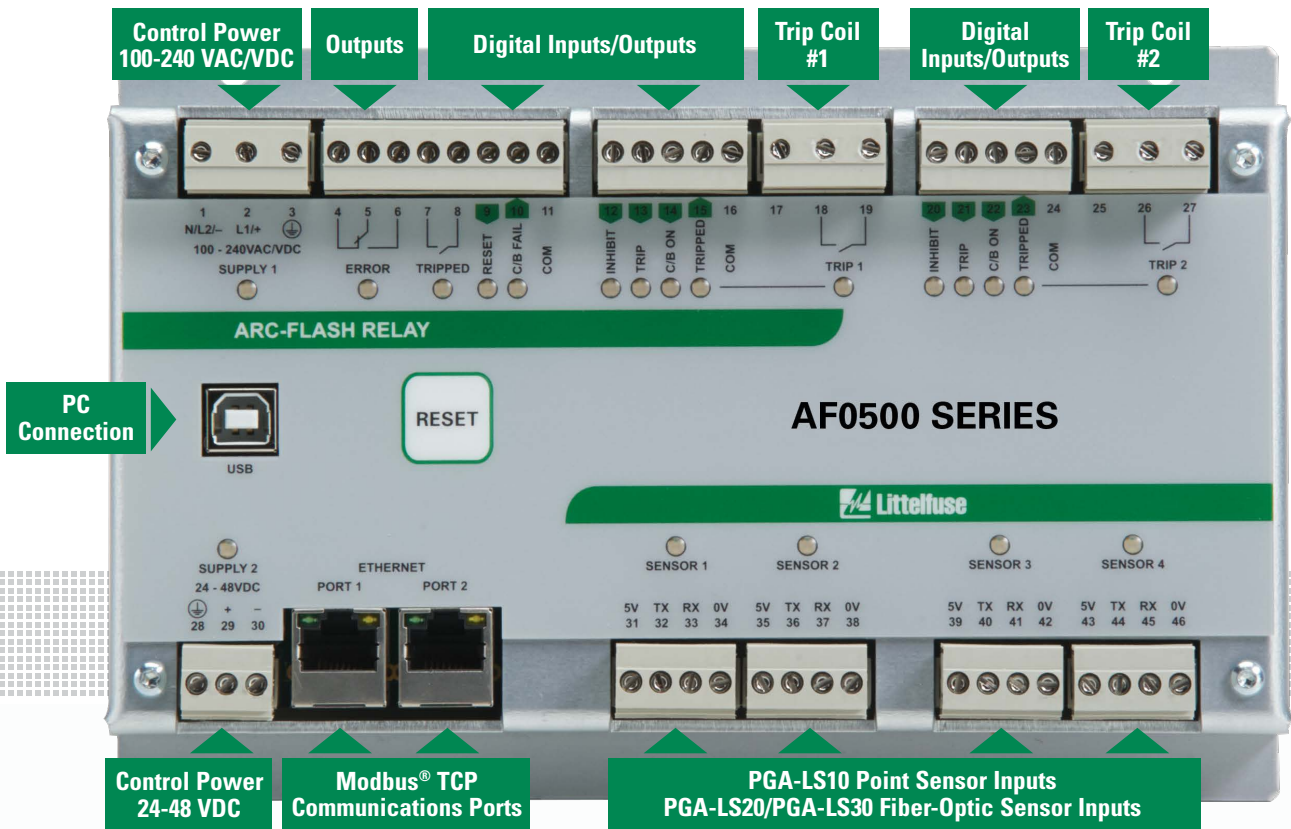

In the Zone

The AF0500 Arc-Flash Relay provides tie breaker and zone tripping capabilities - one relay trips two separate zones. With unrestricted scalability, multiple AF0500 relays can be connected to cover multiple zones.

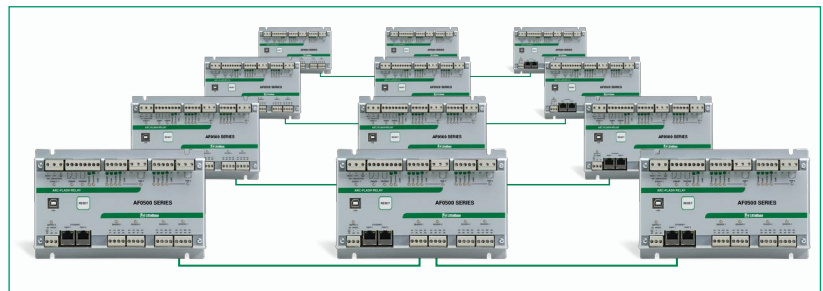

Technology

AF0100 Arc-Flash Relay

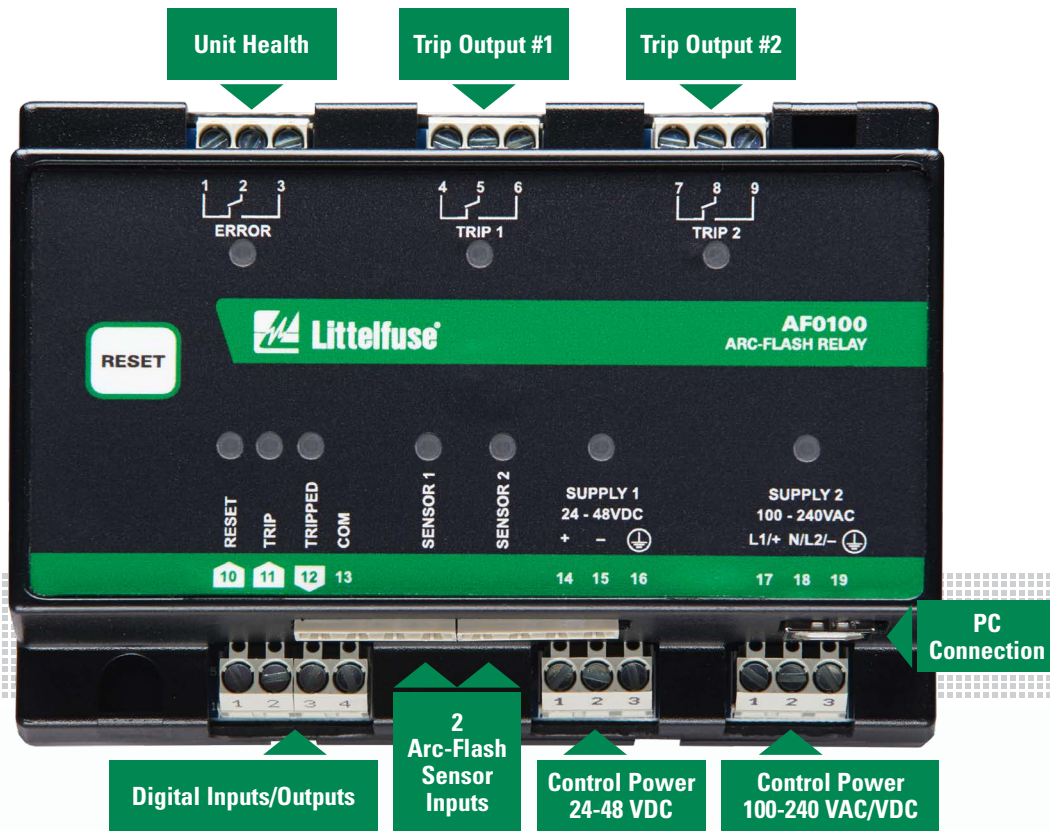

Mighty Small

Smaller incident energy. Smaller footprint. Smaller cost. The AF0100 delivers leading arc-flash technology at a size and price to make improved electrical safety accessible for everyone.

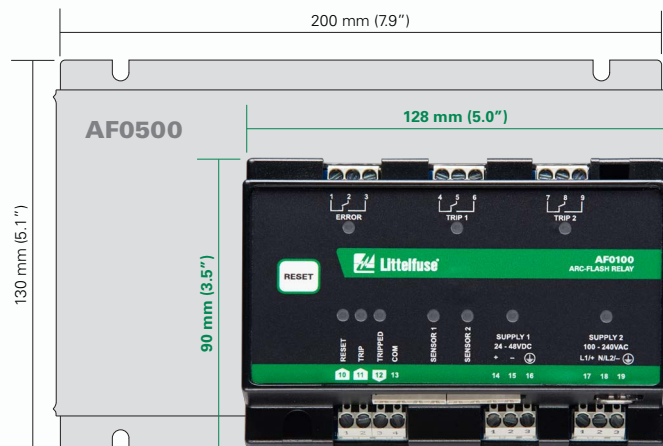

Application Examples

PGR-8800

Switchgear Protection

The PGR-8800 monitors each cabinet with a PGA-LS10 point sensor, providing arc-flash protection and fault location indication. The entire length of the back bus bar is monitored by a PGA-LS20 or PGA-LS30 fiber-optic sensor. The PGR-8800 uses current transformers to monitor the current, and trips the local "feeder" circuit breaker only when high amounts of light and current are present. The PGR-8800 is also configured to only trip the upstream "main" breaker if the local circuit breaker fails to open.

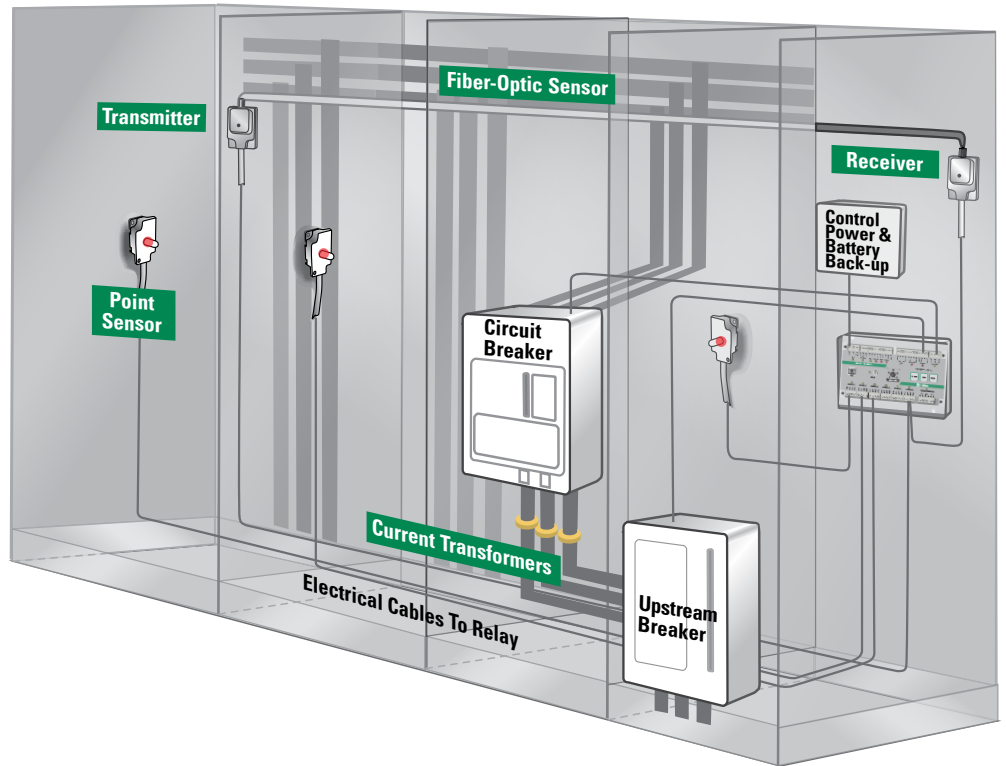

AF0500

Main-Tie-Main Protection

In a main-tie-main application, arc-flash energy can come from either main. Protection zones on the AF0500 remove power from the faulted section of the bus by tripping that main and the tie breaker (coupler). Relay A can directly trip both its Main and the tie breaker. Relay B trips its Main and uses a high-speed digital output to make Relay A open the Tie Breaker.

In the event of an arc flash in the tie breaker cabinet, both mains must be tripped. Here, Relay A will trip its Main and use a digital output to make Relay B trip Main Breaker B.

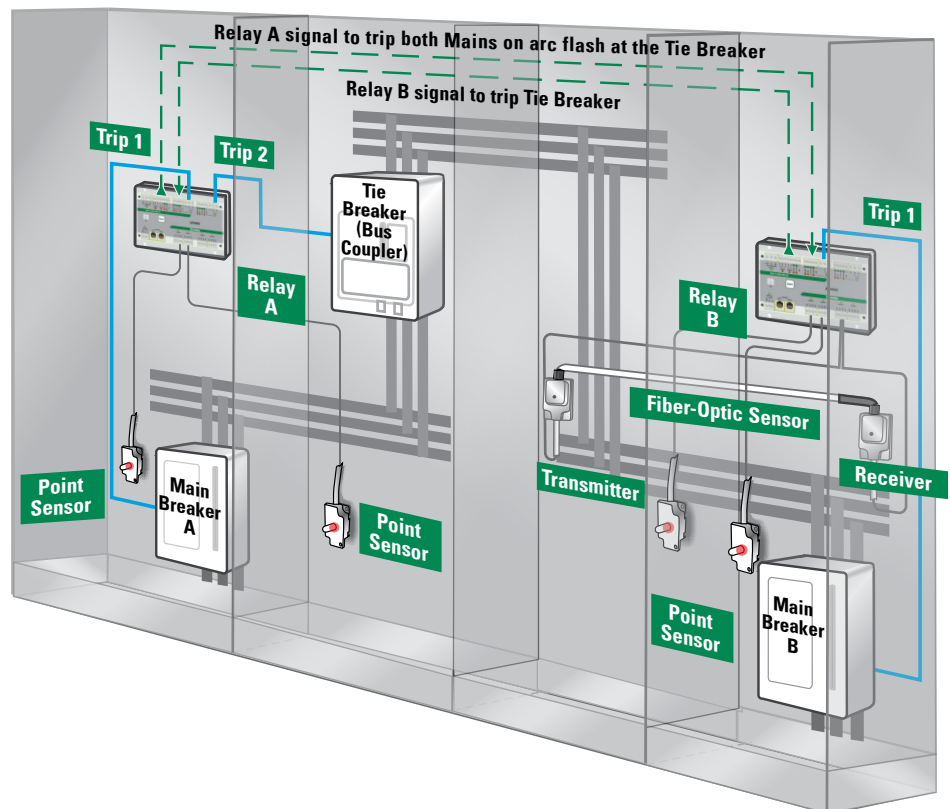

AF0100

Generator Protection

Generators are often the last line of defense in powering and protecting critical applications. The generator breaker is the last line of defense protecting the generator itself: there is no protection at all between the line side of the breaker and the generator.

The AF0100 includes two Form-C Trip outputs that quickly respond to an arc flash, turning off the generator using the AVR or other control circuits and disconnecting from the utility or parallel generators by tripping the generator breaker. The AF0100 can be supplied directly off a battery bank and withstand the challenging environment, vibration, and space requirements of a generator application.

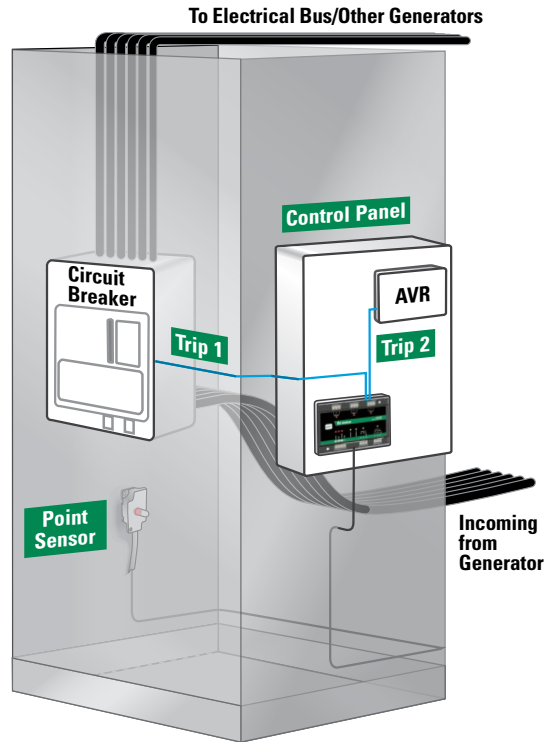

Fiber-Optic Sensor

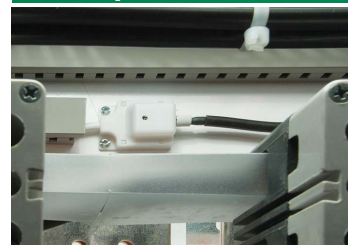

PGA-LS20 and PGA-LS30

Detects light 360° along the entire length of the exposed fiber. Sensor is pre-wired with 10 m (expandable to 50 m) of electrical cable and a plug-in terminal block.

Point Sensor



PGA-LS10

Detects light at 180° angle in line of sight. Sensor is pre-wired with 10 m (expandable to 50 m) of electrical cable and a plug-in terminal block.

Build an Arc-Flash Protection System

Connect the AF0100 and AF0500 together to design a right-sized protection system. Use the innovative digital input and output terminals to add sensors or zones. Build your custom protection without complex programming or configuration.



AF0100
Adds 2 sensors and outputs to Zone 1

SYSTEM

2 zones
4 sensors/zone
1 IGBT and 3 relays/zone



AF0100
Adds 2 sensors and outputs to Zone 2



AF0500
2 sensors/zone
1 IGBT/zone
1 relay/zone

Zone 1 Zone 2

NOTE: Each Digital In/Out connection adds ~0.5 ms

Breaker Connection



Sends trip signal to breaker trip coil (undervoltage or shunt trip) to interrupt power. Ability to trip upstream breaker if local breaker fails.

Current Transformers







Optional, PGR-8800 only

Measures current to help eliminate nuisance trips.

Reliable Operation with Built-In Redundancies

When you are entrusting a safety device to protect equipment from catastrophic damage, it is important to know that it will operate as expected. Littelfuse Arc-Flash Relays do this by having built-in redundancies and health monitors, making maintenance and installation tasks faster, more efficient and helping to minimize downtime.

	AF0100	AF0500	PGR-8800
 Redundant Internal Trip Path <ul style="list-style-type: none"> Two internal trip paths for added reliability—if the microprocessor trip path fails, the backup analog trip path will seamlessly take over, sending an alarm notification to operators Backup analog trip path initializes very quickly upon power up, ensuring protection is enabled while energizing the system when hazard risk is higher 	✓	✓	✓
 Health Monitoring <ul style="list-style-type: none"> Continuously monitors connection to trip coil to ensure path is intact LED indication of sensors' "Ready" or "Tripped" status on sensor and relay Sensors are durable enough to withstand a detected arc-flash event 	✓	✓	✓
 Reliable Light Detection <ul style="list-style-type: none"> Two types of light sensors (point and fiber-optic) for different applications Adjustable light-level and wide-angle detection add flexibility Durable and flexible sensor design eliminates breakage and re-work 	✓	✓	✓
 High-Speed (<1 ms) Trip <ul style="list-style-type: none"> Rapidly initiate the removal of power to reduce the incident energy of the arc flash 		✓	✓
 Upstream Tripping <ul style="list-style-type: none"> Ability to trip upstream device if the local breaker fails to clear the fault 		✓	✓
 Data Logging <ul style="list-style-type: none"> Quickly assess the factors that led to a trip in order to get back online quickly 		✓	✓
 Optional Current Detection for Fault Verification <ul style="list-style-type: none"> Avoid nuisance tripping with current-supervised arc-flash trips Phase Current Transformers for overcurrent detection Two user-defined definite-time overcurrent protection levels and times 			✓
 Tie Breaker Tripping <ul style="list-style-type: none"> Ability to trip both incoming feeder and tie breaker when arc is detected in one section of a switchboard Affected part of the switchboard is isolated from the non-affected part 		✓	
 Zone Tripping <ul style="list-style-type: none"> Ability to trip 2 separate zones with 1 relay Sensor zone assignment through simple PC configuration and/or digital inputs and outputs 		✓	

Superior and Robust Sensor Design

PGA-LS10



Point Light Sensor

Line-of-sight light sensor detects an arc as small as 3 kA in a 2-meter half-sphere radius.

- Visual LED indication for “Ready” or “Tripped” state to assist with fault location
- Robust sensor design can withstand a detected arc-flash event
- Sensor can be installed up to 50 m (164 ft) away from relay; electrical cable can be cut and easily re-terminated in the field

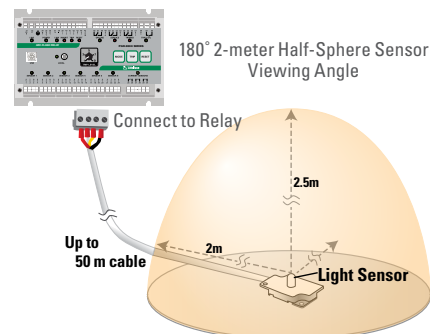

PGA-LS20/PGA-LS30

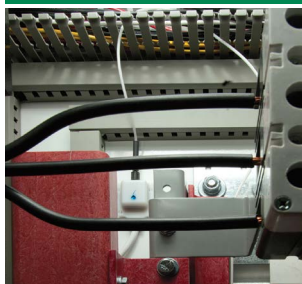

Fiber-Optic Light Sensor

The 360° light sensor detects light throughout the entire length of the fiber. Ideal to protect bus bars, multiple compartment installations like motor control centers, or areas with many obstructions.

- Visual LED indication for “Ready” or “Tripped” state to assist with fault location
- Durable resin fiber material allows small bending radius (>5 cm) and greater flexibility without breaking
- Ready to install from the factory, no need to terminate in the field or polish as with glass fiber
- Fiber sensors can be installed in locations up to 50 m (164 ft) away from relay; electrical cable can be cut and easily re-terminated in the field

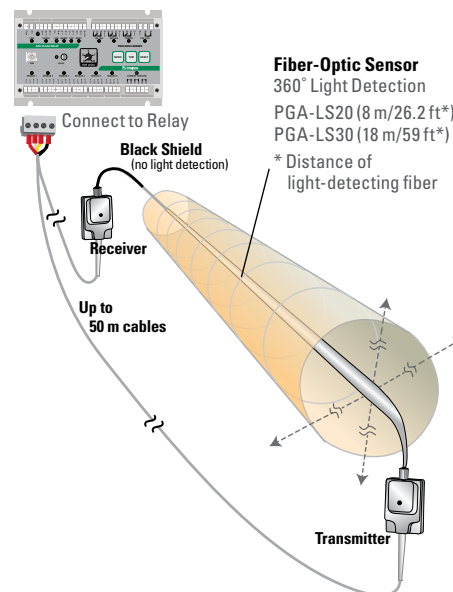

Sensor Placement Recommendations

Generally, it is recommended to mount 1 or 2 sensors per cubicle to cover all horizontal and vertical bus bars, breaker compartments, drawers, and anywhere that there is potential for an arc fault. Threading a fiber-optic sensor through the cabinets and in areas where point-sensor coverage is uncertain results in complete coverage and an added level of protection. Even if policy is to only work on de-energized systems, all maintenance areas should be monitored for arc flash to prevent potential damage and additional cost. For more information, download the Installation Guide PF711 from Littelfuse.com/ArcFlash.

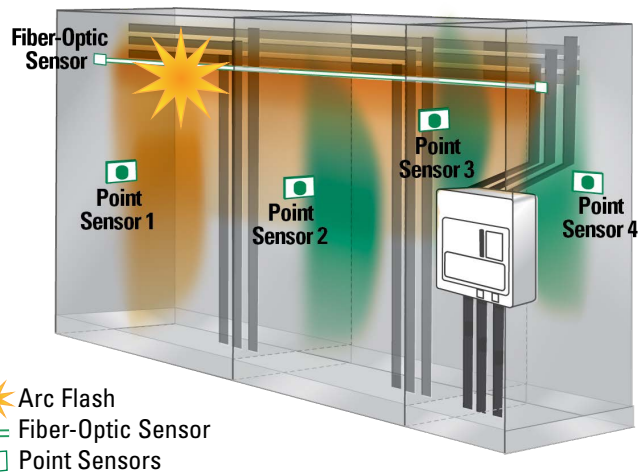

Scenario with point sensor placement on the wall of each compartment. Arc detection area for each sensor is shown in green shade. In this case, both Point Sensor 1 and the Fiber-Optic Sensor detected the flash as it was within their viewing area (shown in orange).

FAQ

Do arc-flash relays lower the Personal Protective Equipment (PPE) required?

In order to lower the amount of PPE required, the incident energy must be reduced. There are two ways to lower the incident energy of an arc-flash event, reducing the fault current or the clearing time and reducing the available energy. Reducing the available energy can be achieved by using current-limiting fuses and, for single-phase faults, resistance grounding. Reducing the clearing time typically is not possible when using overcurrent protection due to system coordination requirements. Current-based protection must have sufficient delay to prevent unnecessary tripping on momentary overload or current spikes, thus losing valuable reaction time. Arc Flash relays resolve this issue by relying primarily on light, which allows for the quickest reaction time in the industry. The PGR-8800 and AF0500 relays can detect an arcing condition and send a trip signal to the circuit breaker within 1 ms. The AF0500 reaction time is between 3-8 ms depending on configuration. This detection time is much faster than standard protection and circuit breakers, which means using an Arc Flash relay in combination with a circuit breaker (PGR-8800 only) will lower the incident energy. This results in an increase in worker safety, less fault damage, and improved uptime. While the arc-flash energy has decreased, determining if the reduction will result in a decreased PPE category will ultimately depend on the electrical system.

What are typical arc-flash protection applications?

Although an arc flash is improbable on systems operating at 208 V or less, systems with higher voltages have sufficient capacity to cause an arc flash and should use proper protection. Arc-flash protection is especially important in the following applications:

Solidly grounded electrical distribution systems: It is estimated that over 95% of all electrical faults are, or begin as, a ground fault. Ground-fault current on a solidly grounded system is only limited by the resistance of the fault and system impedance, and has the potential to cause an arc flash.

Alarm-only systems: When ground faults are allowed to persist on a system, particularly in an ungrounded system, the faults can cause rapid deterioration of electrical safety and escalation into an arc flash.

High-Current Systems: The 2017 US NEC, section 240.87 includes “active arc-flash mitigation system” in a short list of options that shall be used to reduce clearing time “Where the highest continuous current trip setting for which the actual overcurrent device installed in a circuit breaker is rated or can be adjust is 1200 A or higher.”

Air-cooled transformers: On air-cooled equipment, the winding insulation, terminals, and ground points are exposed to the environment. Pollution, dust, and other contaminants can cause premature insulation failure and can lower the resistance of the air gap between energized conductors, and between energized conductors and ground. Insulation failure and lower air-gap resistance increase the probability of an arc flash.

Generators: Incident energy levels are typically very high on generators, and portable generators are often in enclosed trailers which make maintenance difficult and dangerous.

Rack-out breakers: As a circuit breaker is racked out, there is a potential for an arc flash to develop when the electrical contacts are disconnected while energized.

Devices with high inrush currents: Transformers, capacitor-banks, surge arrestors, large motors, and other reactive loads will cause a high-inrush current when energized. To allow these systems to operate properly, instantaneous-current settings on circuit breakers will either be set very high or not used, allowing an arc-flash to remain on the system for longer, or not be detected at all.

Low-voltage equipment: Higher fault currents at lower voltage and a mentality that lower voltages are safer than high voltages mean that many arc-flash incidents actually occur on low-voltage equipment.

Medium and high-voltage equipment: Medium-voltage equipment (4160 V and higher) often uses air insulation.

Moveable and mobile electrical equipment: Mobile electrical equipment is subject to physical damage while in motion and has a higher potential for an arc flash. The designs are often more compact, reducing air gap insulation levels.

Areas where work or maintenance is regularly performed on energized equipment: While maintenance personnel are required to wear proper PPE when working on or around energized equipment, an arc-flash relay can be used to lower the levels of hazard that personnel are exposed to.

Older facilities: Where often, room is not available for any other means of Arc-Flash Hazard mitigation.



Technical Specifications



PGR-8800 Arc-Flash Relay

Relay Part Nos.	PGR-8800-00 PGR-8800-00-CC (conformal coating)
Sensor Inputs	6 light sensor inputs for PGA-LS10, PGA-LS20 and PGA-LS30 sensors
Sensor Part Nos.	PGA-LS10 (Point) PGA-LS20 (Fiber-Optic) PGA-LS30 (Fiber-Optic)
IEEE Device No.	Overcurrent (50), Arc Flash (AFD)
Input Voltage	100-240 Vac, 110-250 Vdc, or 14-48 Vdc
Dimensions	H 130 mm (5.2") W 200 mm (7.9") D 54 mm (2.2")
Optical Trip Settings	9-25 klux
Trip Coil Output	<1 ms; IGBT switch <u>Current Rating:</u> 750 mA cont. 20 A for 2 s 10 A for 5 s <u>Voltage Rating:</u> 24 to 300 Vac 24 to 300 Vdc
Relay Outputs	Programmable <u>Form C Output Contact:</u> 5 A at 250 Vac/30 Vdc <u>Status Output Contact:</u> 3 A at 50 Vac/50 Vdc
Communications	RS-485, Modbus® RTU
System Expansion	Link up to 4 units
Sensors	Up to 24 (6 per unit)
Battery	24 V lead-acid gel cell (not included)
Approvals	CE, UL Listed (UL508), RCM, CSA, DNV
Warranty	5 years
Mounting	DIN, Surface Mount

PGA-LS10 Point Sensor

Type	Point light sensor
Detection Radius	180° Line-of-sight light sensor
Trip Status LED	Displays "tripped" state on each sensor
Health Status LED	Displays "ready" state on each sensor
Electrical Cable	10 m (32.8 ft) included, expandable to 50 m (164 ft)

PGA-LS20/LS30 Fiber-Optic Sensors

Type	Fiber-optic light sensor
Detection Radius	360° Line-of-sight light sensor
Trip Status LED	Displays "tripped" state on each sensor
Health Status LED	Displays "ready" state on each sensor
Sensor Length	PGA-LS20: 8 m (26.2 ft) active; 10 m (32.8 ft) total PGA-LS30: 18 m (59 ft) active; 20 m (66 ft) total
Electrical Cable	10 m (32.8 ft) included, expandable to 50 m (164 ft)

AF0500 Arc-Flash Relay

Relay Part Nos.	AF0500-00 AF0500-00-CC (conformal coating)
Sensor Inputs	4 light sensor inputs for PGA-LS10, PGA-LS20 and PGA-LS30 sensors
Sensor Part Nos.	PGA-LS10 (Point) PGA-LS20 (Fiber-Optic) PGA-LS30 (Fiber-Optic)
IEEE Device No.	Arc Flash (AFD)
Input Voltage	100 to 240 Vac, 110 to 250 Vdc or 24-48 Vdc
Dimensions	H 130 mm (5.1") W 200 mm (7.9") D 54 mm (2.1")
Optical Trip Settings	10-30 klux
Trip Coil Outputs	<1 ms; IGBT switch <u>Current Rating:</u> 750 mA cont. 20 A for 2 s 10 A for 5 s <u>Voltage Rating:</u> 24 to 300 Vac 24 to 300 Vdc
Communications	Ethernet, 2 ports with internal Ethernet switch, Modbus® TCP
System Expansion	Unlimited
Sensors	4 per unit
Approvals	CE, UL (UL508), RCM
Warranty	5 years
Mounting	Surface, DIN (with optional D0050 adapter clips)

AF0100 Arc-Flash Relay

Relay Part Nos.	AF0100-00: Universal supply AF0100-00-CC: Universal supply (conformal coating) AF0100-10: 24-48 Vdc supply AF0100-10-CC: 24-48 Vdc supply (conformal coating)
Sensor Inputs	2 light sensor inputs for PGA-LS10, PGA-LS20 and PGA-LS30 sensors
Sensor Part Nos.	PGA-LS10 (Point) PGA-LS20 (Fiber-Optic) PGA-LS30 (Fiber-Optic)
IEEE Device No.	Arc Flash (AFD)
Input Voltage	100-240 Vac/Vdc, 24-48 Vdc
AF0100-00	24-48 Vdc
AF0100-10	24-48 Vdc
Dimensions	H 90 mm (3.5") W 128 mm (5.0") D 60 mm (2.4")
Optical Trip Settings	10-25 klux
Trip Coil Outputs	<5 ms (typical); Relay output <u>Current Rating:</u> 6 A cont. 30 A for 0.2 s <u>Voltage Rating:</u> 250 Vac/Vdc 250 Vac/Vdc
Communications	None
System Expansion	Unlimited
Sensors	2 per unit
Approvals	CE, UL (UL508), RCM, FCC
Warranty	2 years
Mounting	Surface, DIN rail

PGA-1100 Diode Logic Unit

Type	Diode Logic Unit
Diodes	1000V reverse voltage, 3 A continuous, 25 A for 1 second
Certification	CE
Dimensions	H 70 mm (2.76") W 20 mm (0.79") D 80 mm (3.15")

Local Resources for a **GLOBAL** Market

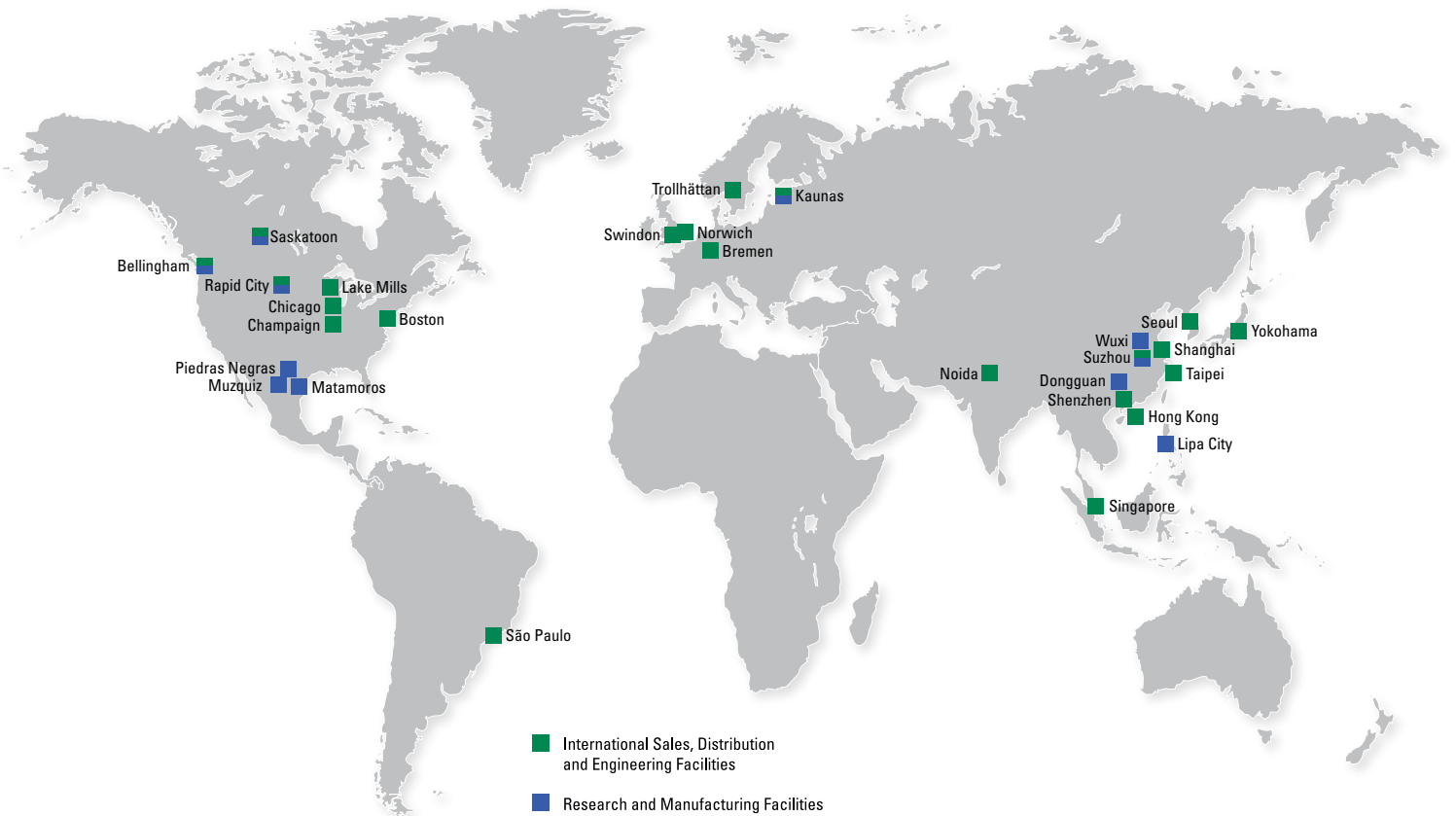

WWW.LITTELFUSE.COM/ARCFLASH

Step-by-Step Instructions For Every Stage of Your Decision Process

Visit Our Online Library at Littelfuse.com/ArcFlash

1. Research

TECHNICAL DOCUMENTS

- White Paper: Key Considerations for Selecting an Arc-Flash Relay (PF765)
- Technical FAQ

VIDEOS

- Overview of Arc-Flash Relay and Applications
- Features, Benefits and Installation of the PGR-8800 and the AF0500

2. Design & Specification

PRODUCT LITERATURE

- Datasheet
- Users' Manual
- Guideform Specification

ARC FLASH CALCULATOR

- See how much you can reduce incident energy in your facility with our Energy Reduction Calculator.

3. Purchase Decision

Use our **Workbook** to quantify the impact of the PGR-8800, AF0500, and AF0100 before you buy. The Littelfuse Arc-Flash Incident Energy Reduction Workbook (PF710) helps create a preliminary calculation of the reduction of Incident Energy by applying the PGR-8800, AF0500, or AF0100 Arc-Flash Relay. It offers a typical scenario calculation as defined per IEEE 1584.

4. Installation & Maintenance

PRODUCT LITERATURE

- Application Guide (PF711)
- Commissioning Check-list (in Application Guide)

5. Post-Installation Support

Technical support from our professional engineers at **1-800-832-3873**

Littelfuse World Headquarters

8755 West Higgins Road, Suite 500
Chicago, IL 60631, USA

Technical Support:

Tel: +1-800-TEC-FUSE
E-mail: techline@littelfuse.com

Customer Service:

Tel: +1-800-227-0029
E-mail: PG_CSG@littelfuse.com
Fax: +1-847-787-5190

Littelfuse SymCom

222 Disk Drive
Rapid City, SD 57701, USA

Technical Support:

Tel: +1-800-832-3873
E-mail: techline@littelfuse.com

Customer Service:

Tel: +1-800-227-0029
E-mail: PG_CSG@littelfuse.com
Fax: +1-605-348-5685

Littelfuse Startco

3714 Kinnear Place
Saskatoon, SK S7P 0A6
Canada

Tel: +1-306-373-5505

Fax: +1-306-374-2245

E-mail: techline@littelfuse.com



Littelfuse products are certified to many standards around the world. To check certifications on specific product please refer to the product datasheet on Littelfuse.com.

Specifications, descriptions and illustrative material in this literature are as accurate as known at the time of publication, but are subject to changes without notice. Visit Littelfuse.com for the most up-to-date technical information.