

GCMS020A120B1H1

1200V 20 mohm SiC MOSFET Module



Features:

- Ultra Low Loss
- High-Frequency Operation
- Zero Reverse Recovery Current from Diode
- Zero Turn-off Tail Current from MOSFET
- Normally-off, Fail-safe Device Operation
- Easy of Paralleling



Applications:

- Solar Inverters
- High Voltage DC/DC Converters
- Motor Drives
- EV Chargers
- UPS

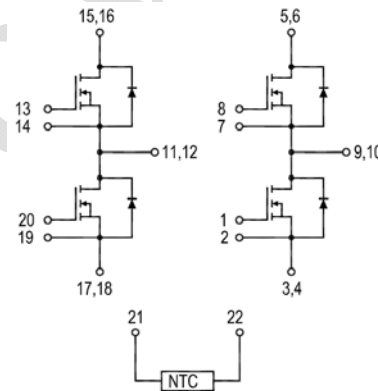

Absolute Maximum Ratings ($T_c=25^{\circ}\text{C}$ unless otherwise specified)

Symbol	Description		Value	Units
V_{DSmax}	Drain-Source Voltage		1200	V
V_{GSmax}	Gate-Source Voltage	Absolute Maximum values	-10/+25	V
V_{GSop}	Gate-Source Voltage	Recommended Operational Values	-5/20	V
$I_{D(DC)}$	Continuous Drain Current	$V_{GS}=20\text{V}, T_c=25^{\circ}\text{C}$	95	A
		$V_{GS}=20\text{V}, T_c=100^{\circ}\text{C}$	80	A
$I_{D(pluse)}$	Pulsed Drain Current	Pulse width t_p limited by T_{jmax}	160	A
P_D	Power Dissipation	$T_c=25^{\circ}\text{C}, T_j=150^{\circ}\text{C}$	305	W

Electrical Characteristics of MOSFET ($T_C=25^\circ\text{C}$ unless otherwise specified)

Symbol	Description	Conditions	Min	Typ	Max	Unit
$V_{(BR)DSS}$	Drain - Source Breakdown Voltage	$V_{GS}=0V, I_D=100\mu A$	1.2			KV
$V_{GS(th) (chip)}$	Gate Threshold Voltage	$V_{DS} = 10 V, I_D = 20 mA, T_J=25^\circ\text{C}$		2.9		V
		$V_{DS} = 10 V, I_D = 20 mA, T_J=125^\circ\text{C}$		2.4		
		$V_{DS} = 10 V, I_D = 20 mA, T_J=150^\circ\text{C}$		2.3		
$V_{GS(th) (terminal)}$	Gate Threshold Voltage	$V_{DS} = 10 V, I_D = 4 mA, T_J=25^\circ\text{C}$		2.9		V
		$V_{DS} = 10 V, I_D = 4 mA, T_J=125^\circ\text{C}$		2.2		
		$V_{DS} = 10 V, I_D = 4 mA, T_J=150^\circ\text{C}$		2.1		
I_{DSS}	Zero Gate Voltage Drain Current	$V_{DS} = 1.2 kV, V_{GS} = 0V$			1	mA
I_{GSS}	Gate-Source Leakage Current	$V_{GS} = 20 V, V_{DS} = 0V$			400	nA
$R_{DS(on) (chip)}$	On State Resistance	$V_{GS} = 20 V, I_{DS} = 80 A, T_J = 25^\circ\text{C}$		20		m Ω
		$V_{GS} = 20 V, I_{DS} = 80 A, T_J = 150^\circ\text{C}$		42		
$R_{DS(on) (terminal)}$	On State Resistance	$V_{GS} = 20 V, I_{DS} = 80 A, T_J = 25^\circ\text{C}$		20		m Ω
		$V_{GS} = 20 V, I_{DS} = 80 A, T_J = 125^\circ\text{C}$		28		
		$V_{GS} = 20 V, I_{DS} = 80 A, T_J = 150^\circ\text{C}$		32		
g_{fs}	Transconductance	$V_{DS} = 20 V, I_{DS} = 80 A, T_J=25^\circ\text{C}$		30.2		S
		$V_{DS} = 20 V, I_{DS} = 80 A, T_J=150^\circ\text{C}$		26.4		
$C_{iss(chip)}$	Input Capacitance	$V_{DS} = 1000V, f = 1MHz,$ $V_{AC} = 25 mV$		3786		nF
$C_{oss(chip)}$	Output Capacitance			300		
$C_{rss(chip)}$	Reverse Transfer Capacitance			20		
E_{on}	Turn-On Switching Energy	$V_{DD} = 600 V,$ $V_{GS} = -5V/+20V$ $I_D = 80 A,$ $R_{G(ext)} = 20 \Omega$	$T_J=25^\circ\text{C}$		1.0	mJ
			$T_J=125^\circ\text{C}$		1.5	
			$T_J=150^\circ\text{C}$		1.6	
E_{off}	Turn-Off Switching Energy		$T_J=25^\circ\text{C}$		0.3	
			$T_J=125^\circ\text{C}$		0.6	
			$T_J=150^\circ\text{C}$		0.8	
$R_{G(int)}$	Internal Gate Resistance	$f = 1MHz, V_{AC} = 25 mV$		0.9		Ω

Q_{GS}	Gate-Source Charge	$V_{DD}= 800\text{ V}, V_{GS} = -5\text{V}/+20\text{V}, I_D= 80\text{ A},$		56		nC
Q_{GD}	Gate-Drain Charge			74		
Q_G	Total Gate Charge			230		
$t_{d(on)}$	Turn-on delay time	$V_{DD} = 600\text{V}, V_{GS} = -5/+20\text{V}, I_D = 80\text{ A}, R_{G(ext)} = 20\ \Omega, \text{Timing relative to } V_{DS}$	$T_j=25^\circ\text{C}$	104		ns
			$T_j=125^\circ\text{C}$	98		
			$T_j=150^\circ\text{C}$	96		
t_r	Rise Time		$T_j=25^\circ\text{C}$	63		
			$T_j=125^\circ\text{C}$	56		
			$T_j=150^\circ\text{C}$	57		
$t_{d(off)}$	Turn-off delay time		$T_j=25^\circ\text{C}$	181		
			$T_j=125^\circ\text{C}$	216		
			$T_j=150^\circ\text{C}$	220		
t_f	Fall Time	$T_j=25^\circ\text{C}$	94			
		$T_j=125^\circ\text{C}$	99			
		$T_j=150^\circ\text{C}$	99			
$R_{\theta JCM}$	Thermal Resistance Junction-To-Case for MOSFET			0.41		$^\circ\text{C}/\text{W}$

Built-in SiC Body Diode Characteristics ($T_C=25^\circ\text{C}$ unless otherwise specified)

Symbol	Description	Conditions	Min	Typ	Max	Unit
$V_{SD(chip)}$	Diode Forward Voltage	$I_{SD} = 40\text{ A}, V_{GS} = -5\text{V}, T_j=25^\circ\text{C}$		3.6		V
		$I_{SD} = 40\text{ A}, V_{GS} = -5\text{V}, T_j=150^\circ\text{C}$		3.3		
T_{rr}	Reverse Recovery Time	$I_{SD} = 80\text{ A}, V_{GS} = -5\text{V}, T_j=25^\circ\text{C}, V_R=800\text{V}, di_F/dt= 2200\text{ A}/\mu\text{s}$		108		ns
Q_{rr}	Reverse Recovery Charge			566		nC
I_{rrm}	Peak Reverse Recovery Current				30	

Free-Wheeling SiC Diode Characteristics ($T_C=25^\circ\text{C}$ unless otherwise specified)

Symbol	Description	Conditions	Min	Typ	Max	Unit
$V_{F(\text{terminal})}$	Diode Forward Voltage	$I_F = 80 \text{ A}, V_{GS} = 0 \text{ V}, T_J=25^\circ\text{C}$		2.5		V
		$I_F = 80 \text{ A}, V_{GS} = 0 \text{ V}, T_J=125^\circ\text{C}$		2.9		
		$I_F = 80 \text{ A}, V_{GS} = 0 \text{ V}, T_J=150^\circ\text{C}$		3.0		
Q_C	Total Capacitive Charge	$V_R = 1200 \text{ V}, T_J = 27^\circ\text{C}$		129		nC
$R_{\theta JC}$	Diode Thermal Resistance: Junction-To-Case			1.21		$^\circ\text{C}/\text{W}$
$I_{F(\text{chip})}$	Continuous Diode Forward Current	$T_C=25^\circ\text{C}, T_J=175^\circ\text{C}$		94		A
		$T_C=125^\circ\text{C}, T_J=175^\circ\text{C}$		52		
		$T_C=150^\circ\text{C}, T_J=175^\circ\text{C}$		35		

Module

Symbol	Description		Min	Typ	Max	Unit
V_{iso}	Isolation Voltage(All Terminals Shorted)	$f = 50\text{Hz}, 1\text{minute}$	2500			V
T_J	Maximum Junction Temperature				150	$^\circ\text{C}$
T_{JOP}	Maximum Operating Junction Temperature Range		-40		+150	$^\circ\text{C}$
T_{stg}	Storage Temperature		-40		+125	$^\circ\text{C}$
$R_{\theta CS}$	Case-To-Sink (Conductive Grease Applied)			0.1		$^\circ\text{C}/\text{W}$
T	Mounting Screw:M6		1.0		1.5	N·m
G	Weight			25		g

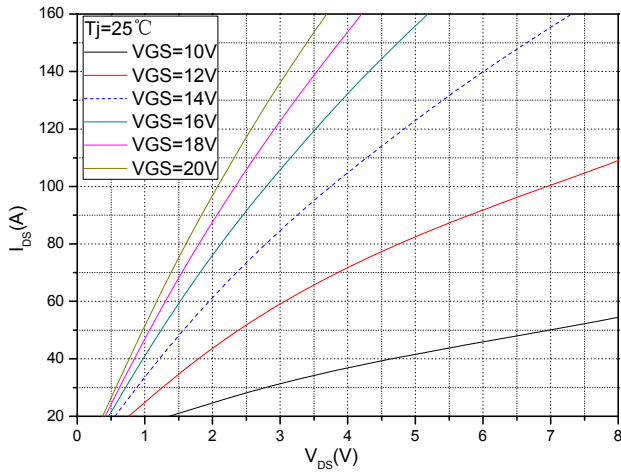

Fig.1 Typical Output Characteristics $T_j=25^{\circ}\text{C}$ (terminal)

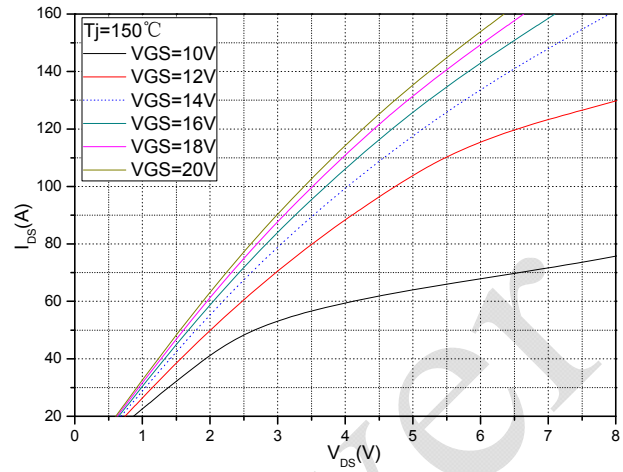

Fig.2 Typical Output Characteristics $T_j=150^{\circ}\text{C}$ (terminal)

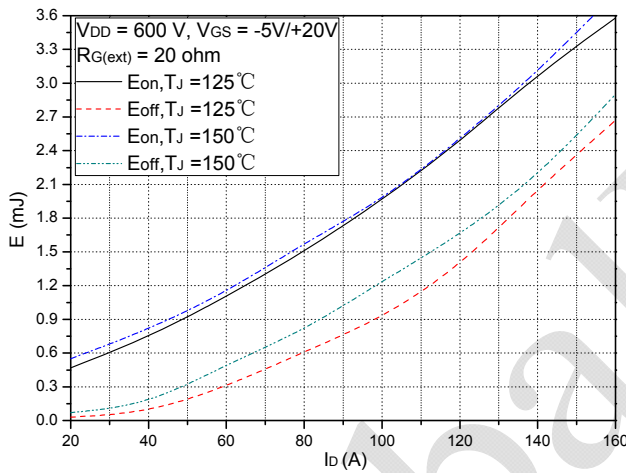

Fig.3 Typical Switching Loss vs. Collector Current

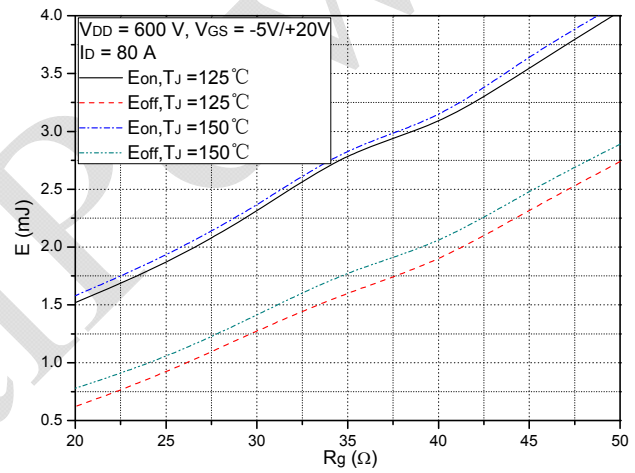

Fig.4 Typical Switching Loss vs. Gate Resistance

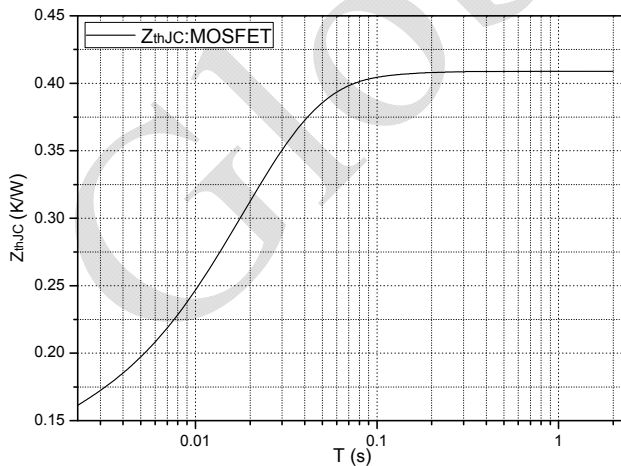

Fig.5 Transient thermal impedance (MOSFET)

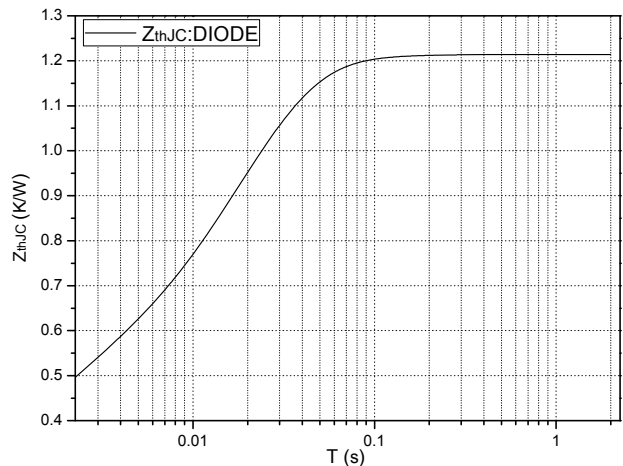

Fig.6 Transient thermal impedance (Free-Wheeling SiC Diode)

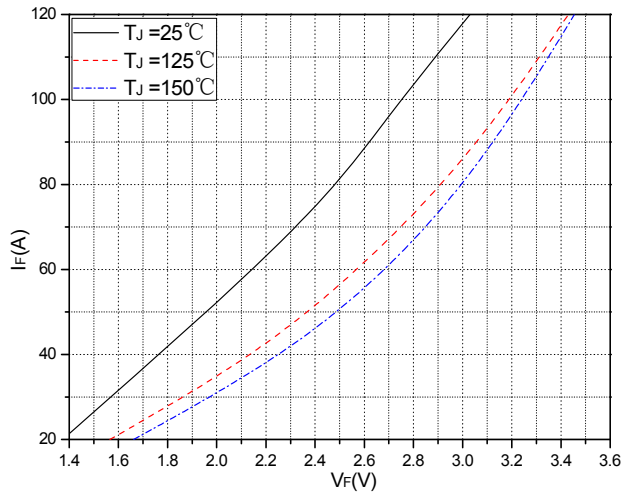

Fig.7 Forward Characteristics of Diode

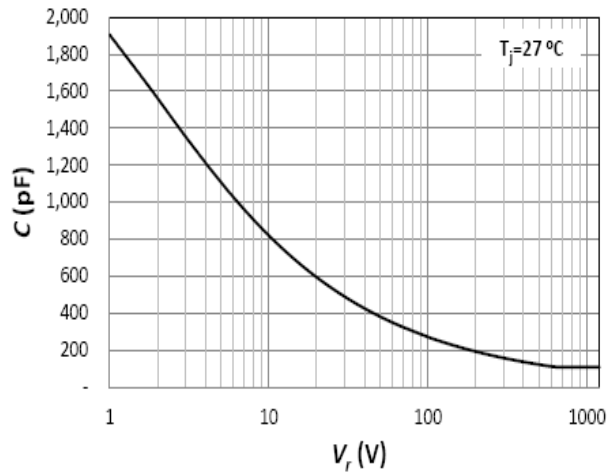

Fig.8 Capacitance (Free-Wheeling SiC Diode)

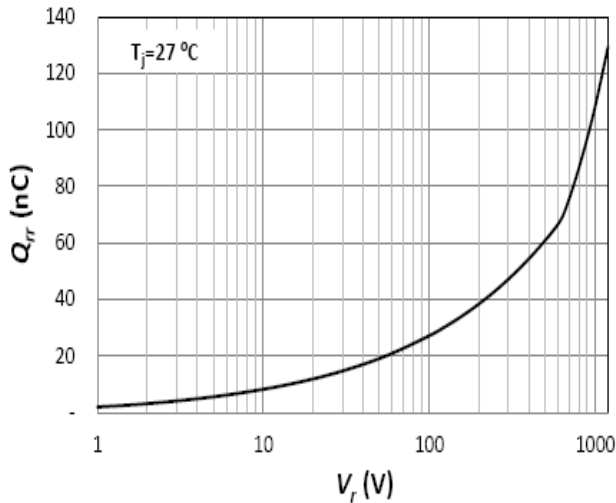

Fig.9 Recovery Charge (Free-Wheeling SiC Diode)

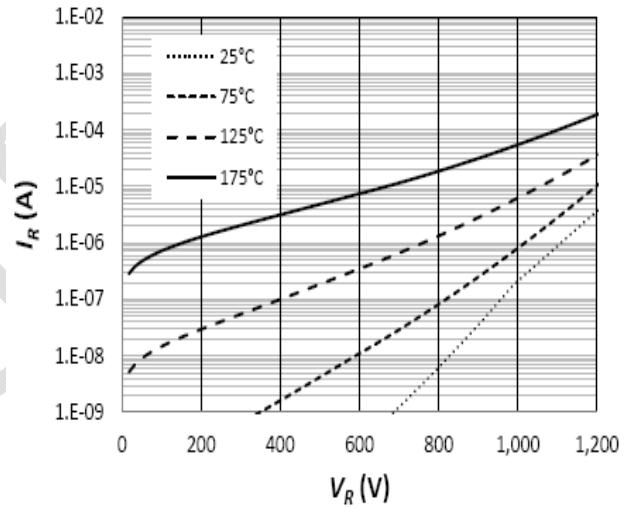

Fig.10 Reverse Characteristics (Free-Wheeling SiC Diode)

Revision History

Date	Revision	Notes
5/29/2015	0.1	Initial release of preliminary datasheet
4/15/2016	0.2	Add the test data and revised package drawing

Global Power Technologies Group

20692 Prism Place
 Lake Forest, CA 92630
 TEL (949) 207-7500
 FAX (949) 613-7600
 E-mail: info@gptechgroup.com
 Web site: www.gptechgroup.com



Notes

- RoHS Compliance**
 The levels of RoHS restricted materials in this product are below the maximum concentration values (also referred to as the threshold limits) permitted for such substances, or are used in an exempted application, in accordance with EU Directive 2011/65/EC (RoHS2), as implemented March, 2013. RoHS Declarations for this product can be obtained from the Product Documentation sections of www.gptechgroup.com.
- REACH Compliance**
 REACH substances of high concern (SVHCs) information is available for this product. Since the European Chemical Agency (ECHA) has published notice of their intent to frequently revise the SVHC listing for the foreseeable future, please contact our office at GPTG Headquarters in Lake Forest, California to insure you get the most up-to-date REACH SVHC Declaration.
 REACH banned substance information (REACH Article 67) is also available upon request.
- This product has not been designed or tested for use in, and is not intended for use in, applications implanted into the human body nor in applications in which failure of the product could lead to death, personal injury or property damage, including but not limited to equipment used in the operation of nuclear facilities, life-support machines, cardiac defibrillators or similar emergency medical equipment, aircraft navigation or communication or control systems, or air traffic control.
- To obtain additional technical information or to place an order for this product, please contact us. The information in this datasheet is provided by Global Power Technologies Group. GPTG reserves the right to make changes, corrections, modifications, and improvements of datasheet without notice.