

3A, 36V, 500kHz Current Mode Asynchronous Step-Down Converter

Purpose

The RT2808A is a current mode asynchronous step-down converter that achieves excellent load and line regulation. This document explains the function and use of the RT2808A evaluation board (EVB) and provides information to enable operation and modification of the evaluation board and circuit to suit individual requirements.

Table of Contents

Purpose	1
Introduction.....	2
Application.....	2
Key Performance Summary Table.....	2
Bench Test Setup Conditions	3
Schematic, Bill of Materials & Board Layout	4
Step-Down Converter Efficiency Test	7
More Information.....	8
Important Notice for Richtek Evaluation Board	8

Introduction

General Product Description

The RT2808A is a current mode asynchronous step-down converter that achieves excellent load and line regulation. Over a wide input voltage range from 5.5V to 36V and supports output current up to 3A. The Current mode operation provides fast transient response and eases loop stabilization. An adjustable soft-start reduces the stress on the input source at start up. In shut down mode, the regulator draws only 25 μ A of supply current. The RT2808A requires a minimum number of readily available external components, providing a compact solution. The RT2808A provides protection functions including input under voltage lockout, cycle-by-cycle current limit, short circuit protection and thermal shutdown protection. The RT2808A is available in the SOP-8 (Exposed Pad) package.

Product Features

- 3A Output Current
- Wide Operating Input Range 5.5V to 36V
- Adjustable Output Voltage from 1.222V to 26V
- High Efficiency up to 90%
- Internal Compensation Minimizes External Parts Count
- Internal Soft-Start
- 110m Ω Internal Power MOSFET Switch
- 25 μ A Shutdown Mode
- Fixed 500kHz Frequency
- Thermal Shutdown
- Cycle-by-Cycle Current Limit
- Available In an SOP-8 (Exposed Pad) Package
- RoHS Compliant and Halogen Free

Application

- Distributive Power Systems
- Battery Charger
- DSL Modems
- Pre-regulator for Linear Regulators

Key Performance Summary Table

Key Features	Evaluation Board Number : PCB011_V1
Default VIN Input Voltage	12V
Max Output Current	3A
Default Output Voltage	2.5V
Default Marking & Package Type	RT2808AGSP, SOP-8 (Exposed Pad)

Bench Test Setup Conditions

Headers Description and Placement

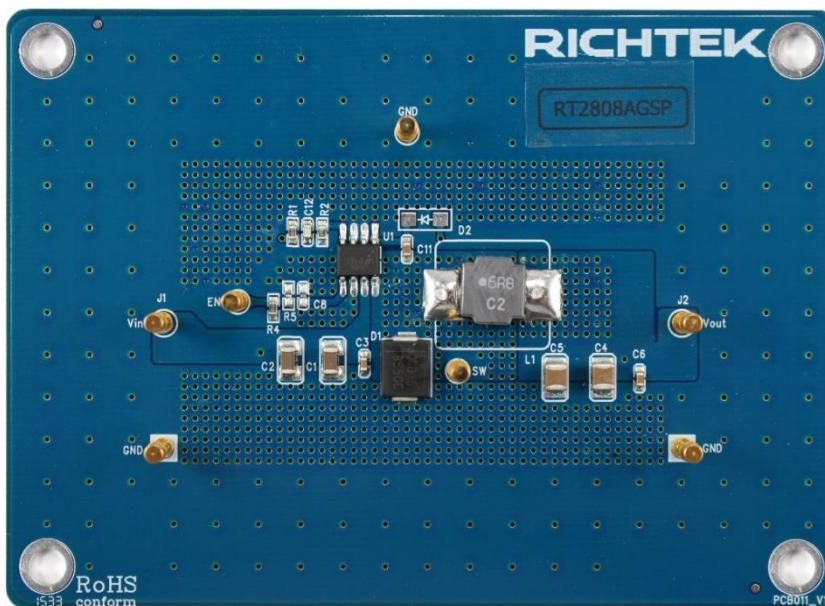

Please carefully inspect the EVB IC and external components, comparing them to the following Bill of Materials, to ensure that all components are installed and undamaged. If any components are missing or damaged during transportation, please contact the distributor or send e-mail to evb_service@richtek.com

Test Points

The EVB is provided with the test points and pin names listed in the table below.

Test point/Pin name	Signal	Comment (expected waveforms or voltage levels on test points)
VIN	Input voltage	Input voltage range = 5.5V to 36V
VOUT	Output voltage	Output voltage = 2.4V
SW	Switch Node	
EN	Chip Enable Operation	The EN pin is externally pulled to High by adding a 100kΩ resistor (R4) from the VIN pin in this EVB setting. For another enable operation, the converter is turned on when the EN pin is higher than 1.4V and turned off when the EN pin is lower than 0.4V.
GND	Ground	Ground. The exposed pad must be soldered to a large PCB and connected to GND for maximum power dissipation.

Power-up & Measurement Procedure

1. Connect input power ($5.5V < V_{IN} < 36V$) and input ground to VIN and GND pins respectively.
2. Connect positive end and negative end of load to Vout and GND of output pins respectively.
3. The output voltage of (V_{OUT}) can be set by R1 and R2.

$$V_{OUT} = V_{REF} * (1 + R1 / R2)$$

where $V_{REF} = 1.222V$ (typ.)

Specification

Parameter	Symbol	Min	Typ.	Max	Units
Input Voltage Range	V _{IN}	5.5		36	V
Output Voltage	V _{OUT}		2.4		V
Oscillator Frequency	f _{OSC}	400	500	600	kHz
Output Current	I _{OUT}			3	A
Current Limit	I _{LIM}	4	5.25	6.5	A

Schematic, Bill of Materials & Board Layout

EVB Schematic Diagram

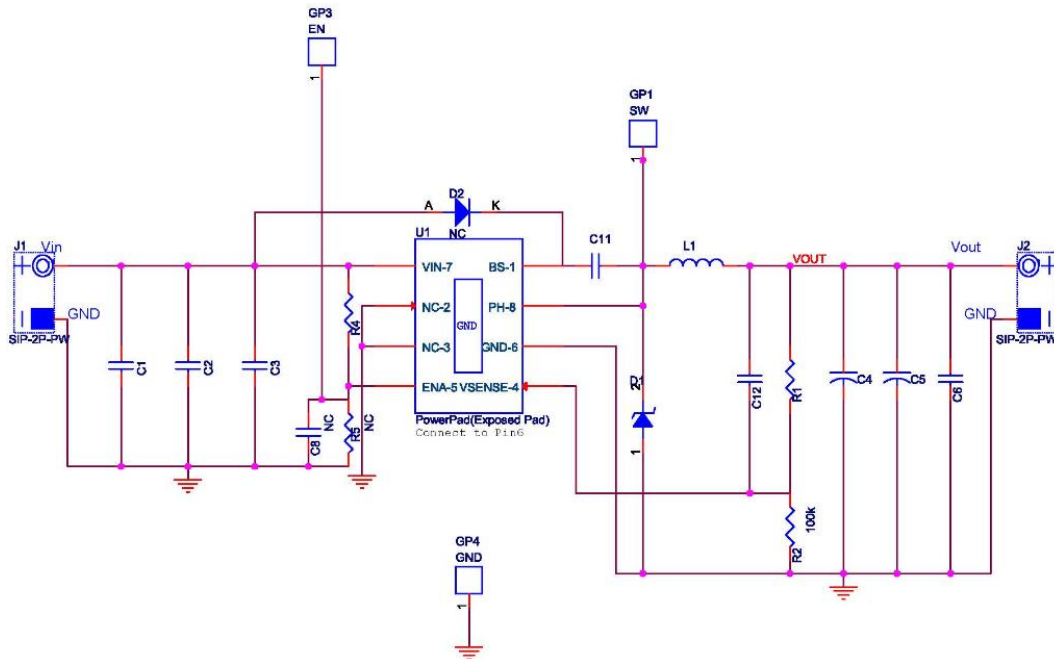

Bill of Materials

Reference	Qty	P/N	Description	Package	Manufacture
U1	1	RT2808AGSP	Step-down converter	SOP-8 (Exposed Pad)	RICHTEK
C1, C2	2	GRM32ER71H475K	4.7μF/50V/X7R	C-1210	MURATA
C3, C6, C11	3	C1608X7R1H104K080AA	0.1μF/±10%/50V/X7R	C-0603	TDK
C4, C5	2	GRM32ER61C226KE20	22μF/±10%/16V/X5R	C-1210	MURATA
C12	1		82pF	C-0603	
L1	1	NR8040T6R8N	6.8μH		TAIYO YUDEN
D1	1	B550C	50V/5A		DIODES
R1, R2, R4	3		100k	R-0402	
C8, R5	2		NC		

PCB Layout

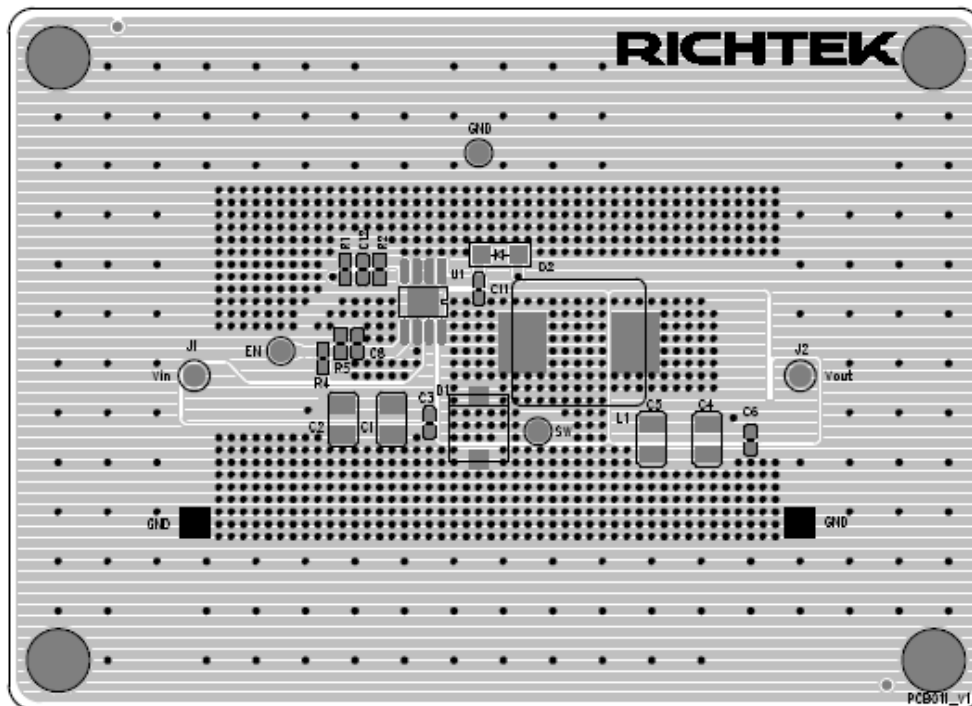

Top View (1st layer)

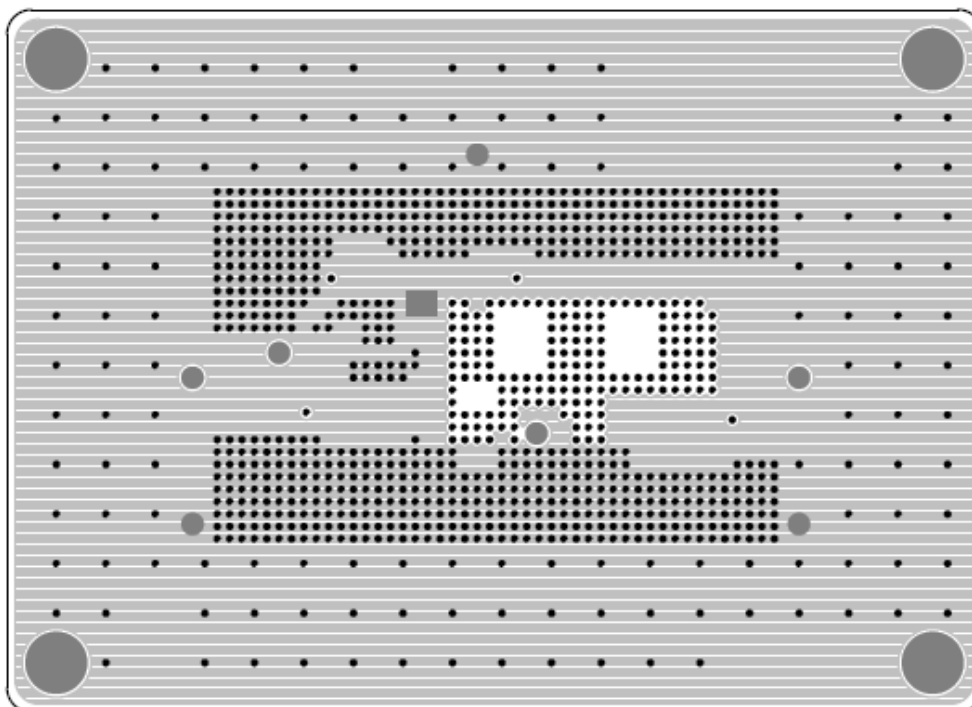

PCB Layout—Inner Side (2nd Layer)

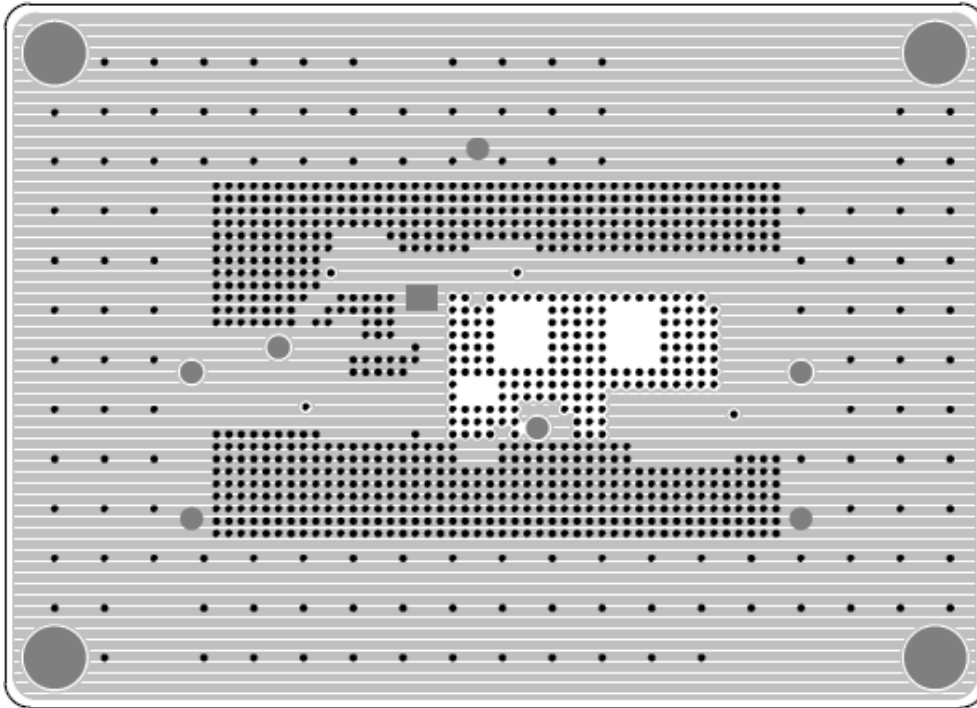

PCB Layout—Inner Side (3rd Layer)

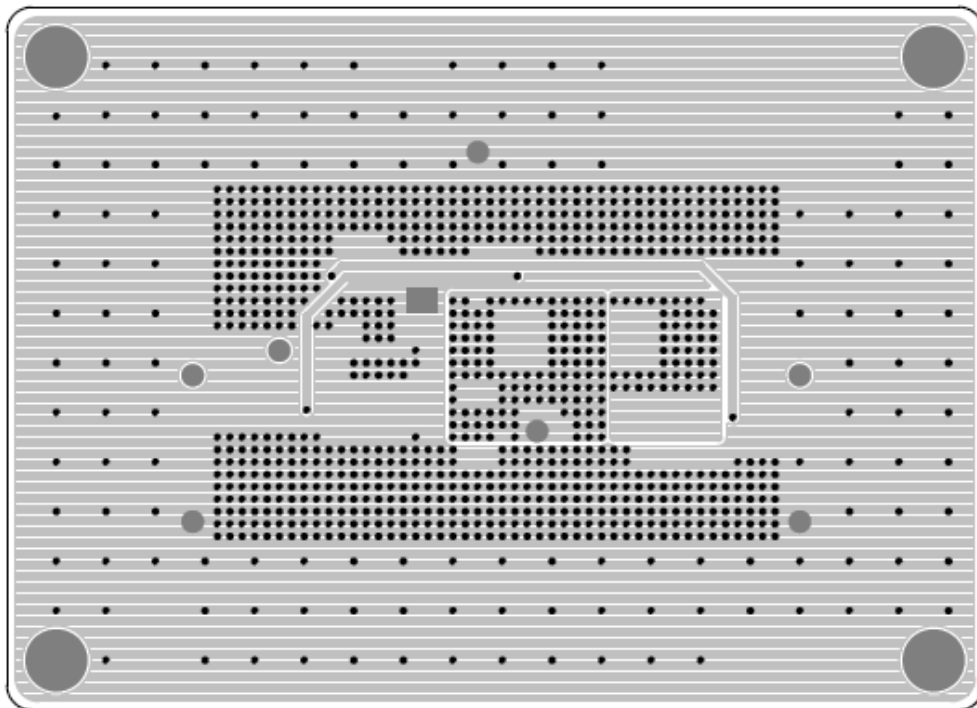

Bottom View (4th Layer)

Step-Down Converter Efficiency Test

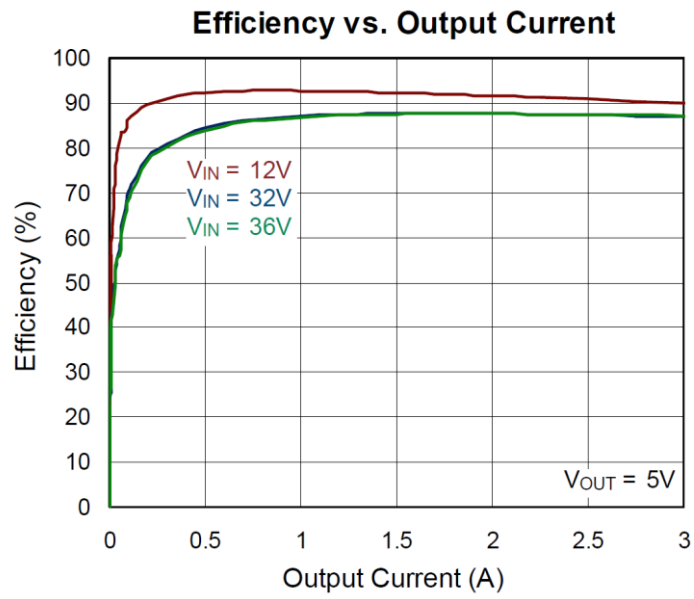

More Information

For more information, please find the related datasheet or application notes from Richtek website <http://www.richtek.com>.

Important Notice for Richtek Evaluation Board

THIS DOCUMENT IS FOR REFERENCE ONLY, NOTHING CONTAINED IN THIS DOCUMENT SHALL BE CONSTRUED AS RICHTEK'S WARRANTY, EXPRESS OR IMPLIED, UNDER CONTRACT, TORT OR STATUTORY, WITH RESPECT TO THE PRESENTATION HEREIN. IN NO EVENT SHALL RICHTEK BE LIABLE TO BUYER OR USER FOR ANY AND ALL DAMAGES INCLUDING WITHOUT LIMITATION TO DIRECT, INDIRECT, SPECIAL, PUNITIVE OR CONSEQUENTIAL DAMAGES.