



**NT Series
Transceiver Module
Data Guide**

Wireless made simple[®]

Warning: Linx radio frequency ("RF") products may be used to control machinery or devices remotely, including machinery or devices that can cause death, bodily injuries, and/or property damage if improperly or inadvertently triggered, particularly in industrial settings or other applications implicating life-safety concerns. No Linx Technologies product is intended for use in any application without redundancies where the safety of life or property is at risk.

The customers and users of devices and machinery controlled with RF products must understand and must use all appropriate safety procedures in connection with the devices, including without limitation, using appropriate safety procedures to prevent inadvertent triggering by the user of the device and using appropriate security codes to prevent triggering of the remote controlled machine or device by users of other remote controllers.

Do not use this or any Linx product to trigger an action directly from the data line or RSSI lines without a protocol or encoder/decoder to validate the data. Without validation, any signal from another unrelated transmitter in the environment received by the module could inadvertently trigger the action. This module does not have data validation built in.

All RF products are susceptible to RF interference that can prevent communication. RF products without frequency agility or hopping implemented are more subject to interference. This module does not have frequency agility built in, but the developer can implement frequency agility with a microcontroller and the example code in Linx Reference Guide RG-00101.

Do not use any Linx product over the limits in this data guide. Excessive voltage or extended operation at the maximum voltage could cause product failure. Exceeding the reflow temperature profile could cause product failure which is not immediately evident.

Do not make any physical or electrical modifications to any Linx product. This will void the warranty and regulatory and UL certifications and may cause product failure which is not immediately evident.

Table Of Contents

1	Description
1	Features
2	Ordering Information
2	Absolute Maximum Ratings
3	Electrical Specifications
6	Typical Performance Graphs
11	Module Description
11	Theory of Operation
12	Pin Assignments
12	Pin Descriptions
14	Sending Data
14	The Data Input
15	The Data Output
15	Using the RSSI Line
16	Using the T/\bar{R}_SEL Input
16	Using the Low Power Features
17	Using the $\overline{\text{READY}}$ Output
17	Using the LVL_ADJ Line
18	Baud Band Selection
19	Channel Selection
20	European Transmission Rules
23	Typical Applications
24	Power Supply Requirements
24	Antenna Considerations
25	Protocol Guidelines
26	Interference Considerations
27	Pad Layout
27	Board Layout Guidelines
29	Microstrip Details

- 30 [Production Guidelines](#)
- 30 [Hand Assembly](#)
- 30 [Automated Assembly](#)
- 32 [General Antenna Rules](#)
- 34 [Common Antenna Styles](#)
- 36 [Regulatory Considerations](#)
- 38 [Achieving a Successful RF Implementation](#)
- 39 [Helpful Application Notes From Linx](#)

NT Series Transceiver Module

Data Guide



Description

The NT Series transceiver module is designed for bi-directional wireless data transfer. The 868MHz version is suitable for European operation and the 900MHz version is suitable for North and South America. The modules have an outstanding range of up to 3,000 feet (914 meters, line of sight). Low power states

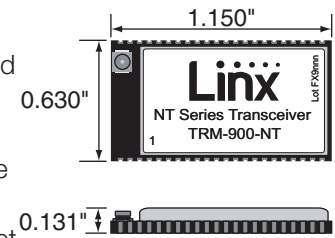

Figure 1: Package Dimensions

optimize current consumption for battery-powered devices.

The modules have two interfaces for data transfer. The first uses a standard Universal Asynchronous Receiver Transmitter (UART) with a simple built-in protocol that supports data rates of 9.6kbps or 56kbps (see Reference Guide 00102). The other option is a transparent interface that bypasses the protocol engine and directly modulates the RF carrier. This supports data rates of up to 300kbps.

The basic configuration settings are done in hardware through the logic state of several pins on the module. Optionally the UART interface can be used for software configuration, also giving access to additional features.

The modules are capable of generating +12.5dBm into 50-ohms and have a typical sensitivity of -113dBm. Housed in a compact reflow-compatible SMD package, the transceivers require no external RF components except an antenna, greatly simplifying integration and lowering assembly costs.

Features

- Long range
- Low cost
- Low power consumption
- No programming required
- 8 parallel selectable channels
- Transparent data transfer
- Data rates up to 300kbps
- RSSI and READY output signals
- Power saving options (POWER_DOWN, STANDBY)
- Adjustable output power level
- No external RF components required
- Wide temperature range
- Compact surface mount package
- No production tuning required

Ordering Information

Ordering Information	
Part Number	Description
TRM-868-NT	868MHz NT Series Transceiver
TRM-900-NT	900MHz NT Series Transceiver
MDEV-868-NT	868MHz NT Series Master Development System
MDEV-900-NT	900MHz NT Series Master Development System

Transceivers are supplied in tubes of 18 pcs.

Figure 2: Ordering Information

Absolute Maximum Ratings

Absolute Maximum Ratings				
Supply Voltage V_{CC}	-0.3	to	+5.5	VDC
Any Input or Output Pin	-0.3	to	$V_{CC} + 0.3$	VDC
RF Input		0		dBm
Operating Temperature	-40	to	+85	°C
Storage Temperature	-55	to	+125	°C

Exceeding any of the limits of this section may lead to permanent damage to the device. Furthermore, extended operation at these maximum ratings may reduce the life of this device.

Figure 3: Absolute Maximum Ratings

Electrical Specifications

NT Series Transceiver Specifications						
Parameter	Symbol	Min.	Typ.	Max.	Units	Notes
Power Supply						
Operating Voltage	V_{CC}	2.5		5.5	VDC	
TX Supply Current	I_{CCTX}					
At +12.5dBm			36	40	mA	1,2
At 0dBm			16	21	mA	1,2
RX Supply Current	I_{CCRX}		19	21	mA	1,2
Power-Down Current	I_{PDN}			1.0	μA	1,2
Standby Current	I_{STD}		1.4	2.5	mA	1,2
RF Section						
Center Frequency Range	F_C					
TRM-868-NT		863		870	MHz	3
TRM-900-NT		902		928	MHz	3
Center Frequency Accuracy		-5		+5	kHz	2
Number of Channels						
TRM-868-NT			8/68			3, 10
TRM-900-NT			8/101			3,10
Channel Spacing			250		kHz	3
Data Rate						
Baud Band = 1		1		19.2	kbps	11
Baud Band = 2		19.2		80	kbps	11
Baud Band = 3		80		160	kbps	11
Baud Band = 4		160		300	kbps	11
Receiver Section						
IF Frequency	F_{IF}					
Baud Band = 1			200		kHz	4,11
Baud Band = 2			200		kHz	4,11
Baud Band = 3			200		kHz	4,11
Baud Band = 4			300		kHz	4,11
Spurious Emissions				-62	dBm	
Receiver Sensitivity						
Baud Band = 1		-111	-113		dBm	5,11
Baud Band = 2		-108	-110		dBm	5,11
Baud Band = 3		-104	-106		dBm	5,11
Baud Band = 4		-100	-102		dBm	5,11

NT Series Transceiver Specifications						
Parameter	Symbol	Min.	Typ.	Max.	Units	Notes
RSSI						
Dynamic Range			60		dB	
Transmitter Section						
Output Power	P_O	-15.5		+12.5	dBm	6
Output Power Control Range			28		dB	
Harmonic Emissions	P_H		-42	-36	dBc	7
Frequency Deviation						
Baud Band = 1			± 30		kHz	3,11
Baud Band = 2			± 55		kHz	3,11
Baud Band = 3			± 80		kHz	3,11
Baud Band = 4			± 120		kHz	3,11
Antenna Port						
RF In/Out Impedance	R_{IN}		50		Ω	
Environmental						
Operating Temp. Range		-40		+85	$^{\circ}C$	
Storage Temp. Range		-55		+125	$^{\circ}C$	
Timing						
Receiver Turn-On Time						
Via V_{CC}			5.0	6	ms	4,9
Via Power Down			5.0	6	ms	4,9
Via Standby			0.6	1	ms	4,8
Transmitter Turn-On Time						
Via V_{CC}			5.0	6	ms	4,9
Via Power Down			5.0	6	ms	4,9
Via Standby			0.7	1	ms	4,8
TX to RX Switch Time			0.7	1	ms	4,8
RX to TX Switch Time			0.7	1	ms	4,8
Channel Change Time			0.6	1	ms	4,8
Baud Band Change Time			4.0	5	ms	4,8
Interface Section						
DATA_IN						
Logic Low	V_{IL}		0.3	$0.2 \cdot V_{CC}$	VDC	
Logic High	V_{IH}	$0.7 \cdot V_{CC}$	$0.5 \cdot V_{CC}$		VDC	
DATA_OUT						

NT Series Transceiver Specifications						
Parameter	Symbol	Min.	Typ.	Max.	Units	Notes
Logic Low	V_{OL}		0.3	0.4	VDC	
Logic High	V_{OH}	$V_{CC}-0.4$	$0.5 \cdot V_{CC}$		VDC	
POWER_DOWN						
Logic Low	V_I			0.8	VDC	
Logic High	V_{IH}	2		5.5	VDC	
Input						
Logic Low	V_{IL}			0.8	VDC	
Logic High	V_{IH}	2		5.5	VDC	
Output						
Logic Low	V_{OL}			0.6	VDC	
Logic High	V_{OH}	$V_{CC}-0.7$		V_{CC}	VDC	
1.	Measured at 3.3V V_{CC}			9.		
2.	Measured at 25 $^{\circ}C$			10.		
3.	Guaranteed by design			68 / 101 channels through the serial interface		
4.	Characterized but not tested			11.		
5.	At the band's low data rate; BER= 10^{-3}			Baud Band is a user selected setting that determines filter settings, max data rate, receiver sensitivity and transmitter frequency deviation. See Baud Band Selection for more details.		
6.	Into a 50-ohm load					
7.	$P_O=+12.5$ dBm (max output power)					
8.	Module is not busy performing other tasks					

Figure 4: Electrical Specifications



Warning: This product incorporates numerous static-sensitive components. Always wear an ESD wrist strap and observe proper ESD handling procedures when working with this device. Failure to observe this precaution may result in module damage or failure.

Typical Performance Graphs

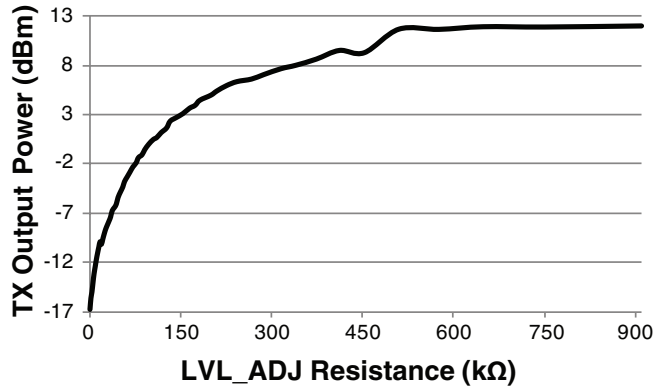

Figure 5: NT Series Transceiver Output Power vs. LVL_ADJ Resistance

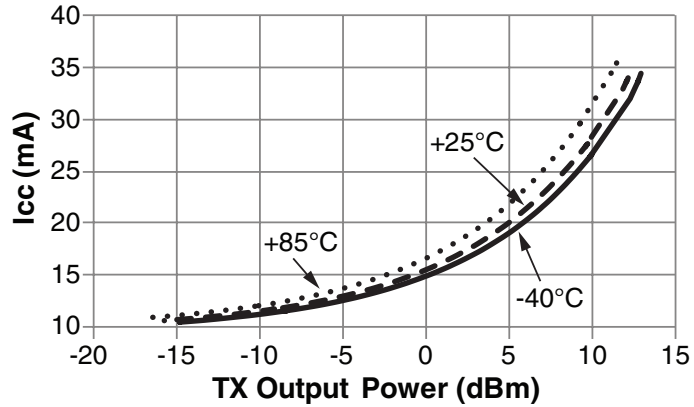

Figure 6: NT Series Transceiver Current Consumption vs. Transmitter Output Power at 3.3V

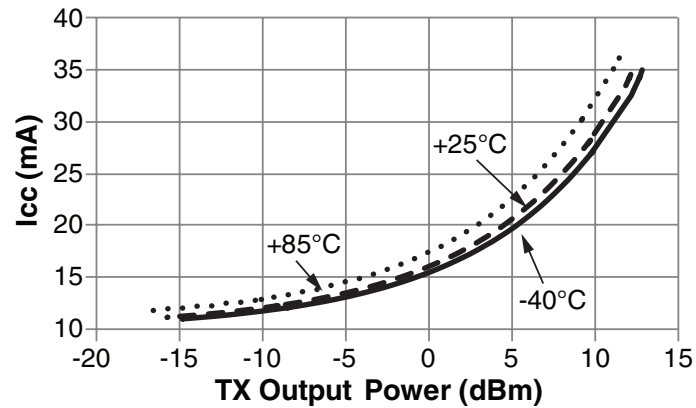

Figure 7: NT Series Transceiver Current Consumption vs. Transmitter Output Power at 5.5V

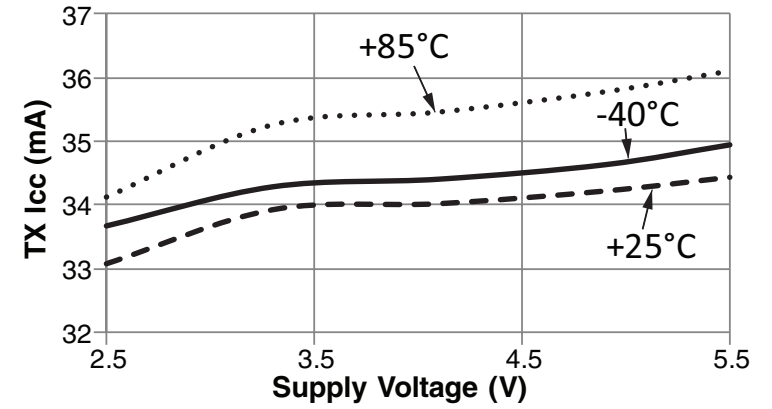

Figure 8: NT Series Transceiver TX Current Consumption vs. Supply Voltage at +12.5dBm

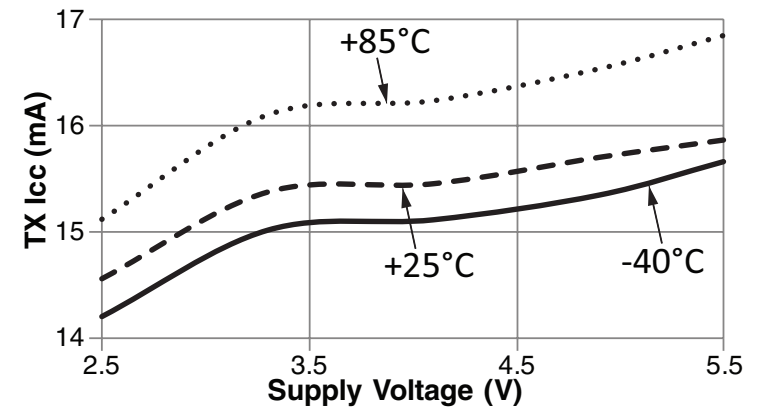

Figure 9: NT Series Transceiver TX Current Consumption vs. Supply Voltage at 0dBm

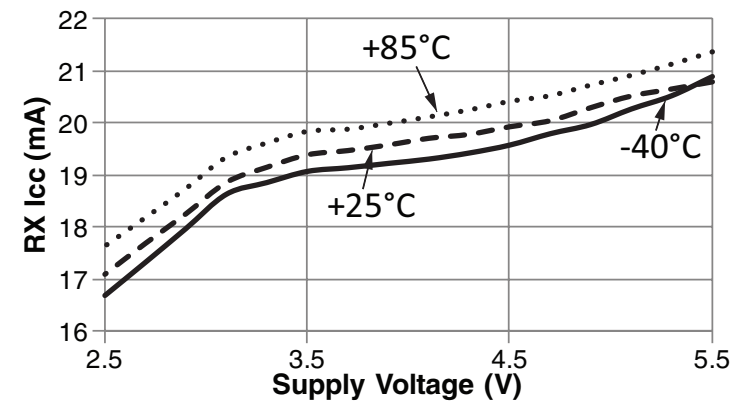

Figure 10: NT Series Transceiver RX Current Consumption vs. Supply Voltage

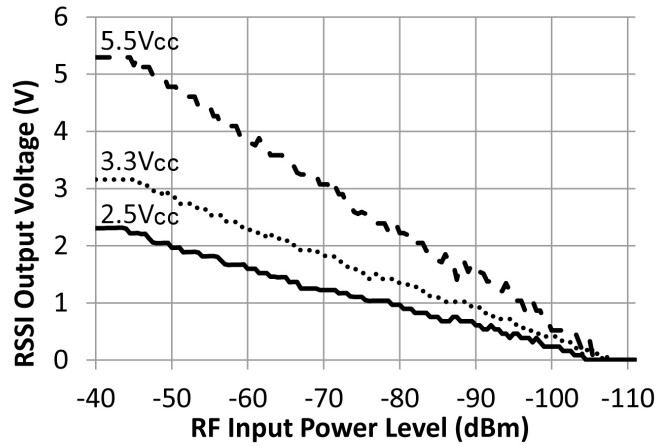

Figure 11: NT Series Transceiver RSSI Voltage vs. Input Power

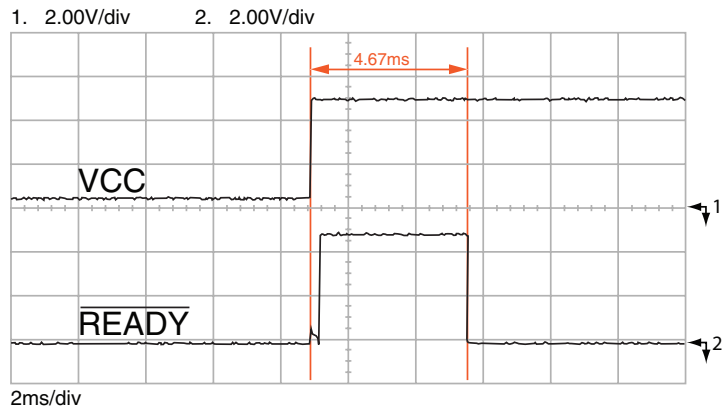

Figure 12: NT Series Transceiver Receiver Turn-On Time from VCC

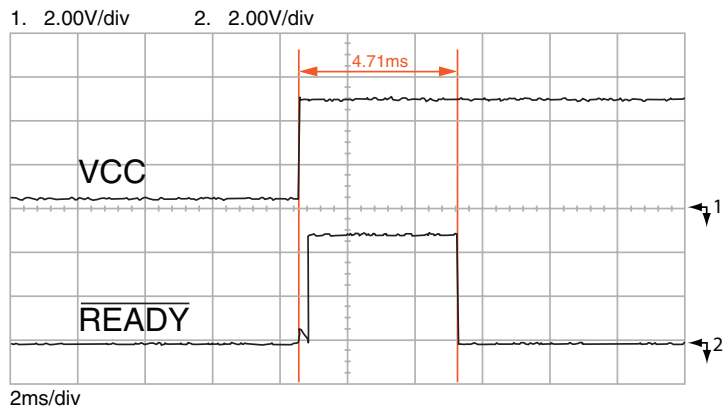

Figure 13: NT Series Transceiver Turn-On Time from VCC

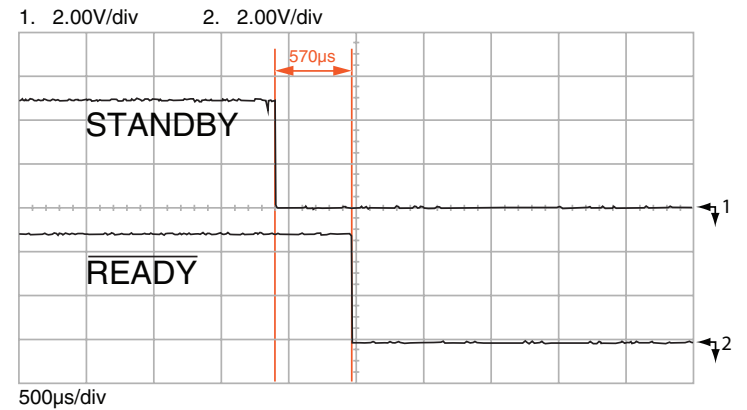

Figure 14: NT Series Transceiver Turn-On Time from Standby

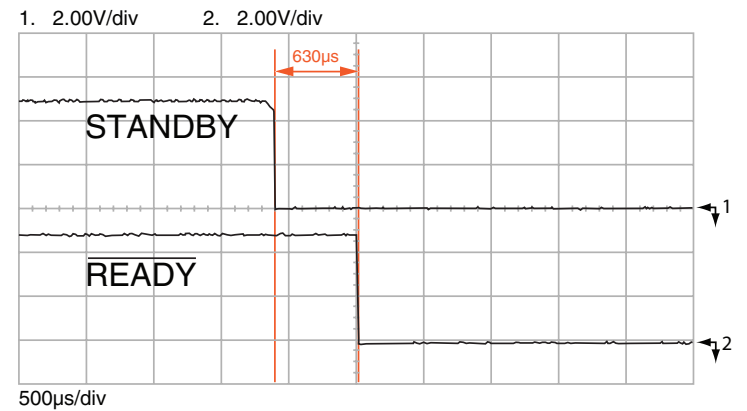

Figure 15: NT Series Transceiver Transmitter Turn-On Time from Standby

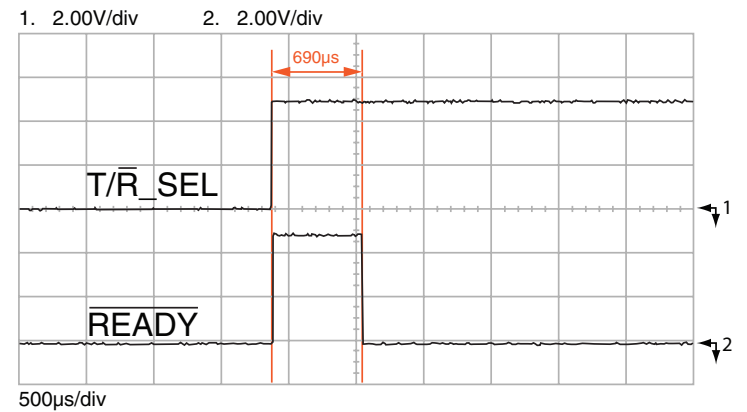

Figure 16: NT Series Transceiver TX to RX Change Time

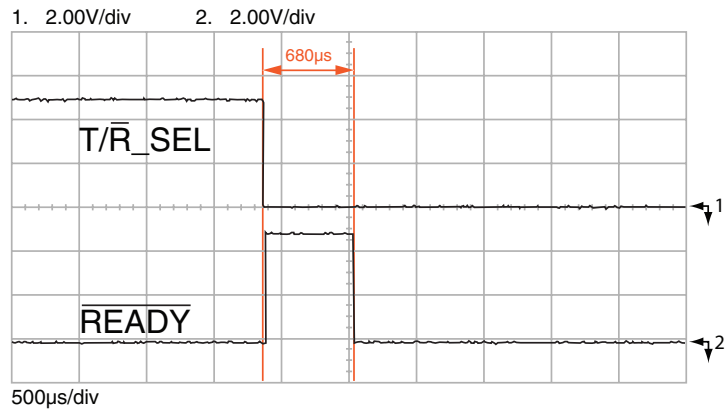

Figure 17: NT Series Transceiver RX to TX Change Time

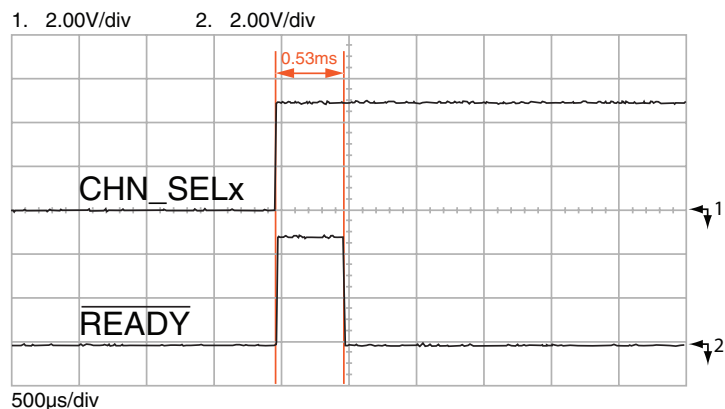

Figure 18: NT Series Transceiver Channel Change Time

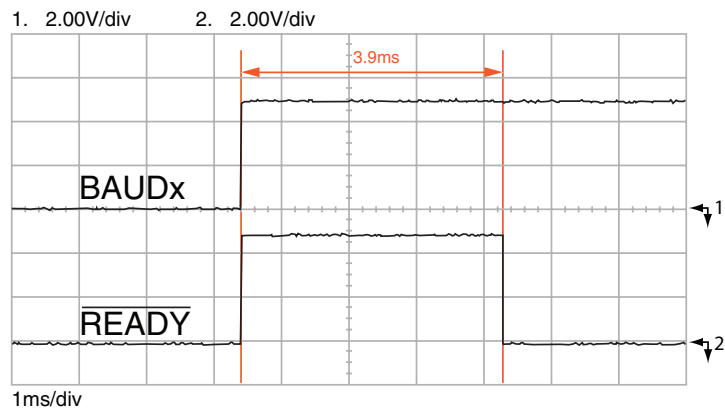

Figure 19: NT Series Transceiver Baud Band Change Time

Module Description

The NT Series transceiver (Figure 20) is a low-cost, high-performance synthesized FSK transceiver capable of transmitting and receiving serial data at up to 300kbps. Its exceptional sensitivity results in outstanding range performance. The module's compact surface-mount package is friendly to automated or hand production. NT Series modules are capable of meeting the regulatory requirements of many domestic and international applications.

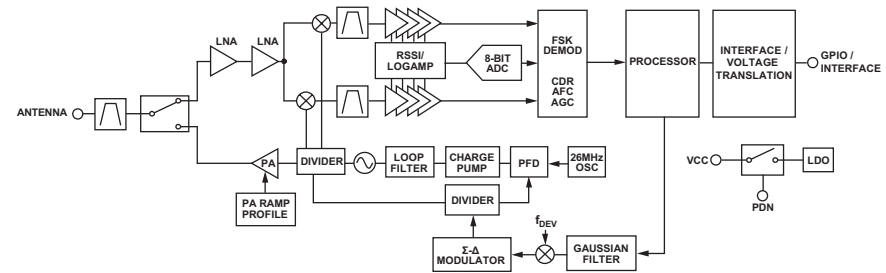

Figure 20: NT Series Transceiver Block Diagram

Theory of Operation

The NT Series transceiver is a highly integrated FSK transceiver designed for operation in the 863–870MHz and 902–928MHz frequency bands. The RF synthesizer contains a VCO and a low-noise fractional-N PLL. The VCO operates at two times the fundamental frequency to reduce spurious emissions. The receive and transmit synthesizers are integrated, enabling them to be automatically configured to achieve optimum phase noise, modulation quality and settling time.

The transmitter output power is programmable from –15.5dBm to +12.5dBm with automatic PA ramping to meet transient spurious specifications. The ramping and frequency deviation are optimized in each of four baud bands to deliver the highest performance over a wide range of data rates.

The receiver incorporates highly efficient low-noise amplifiers that provide up to –113dBm sensitivity. All of the filters are optimized to the highest performance in each of the four baud bands. Advanced interference blocking makes the transceiver extremely robust when in the presence of interferers.

A low-power onboard communications processor performs the radio control and management functions. An interface processor performs the higher level functions and controls the serial and hardware interfaces. This block also includes voltage translation to allow the internal circuits to operate at a low voltage to conserve power while enabling the interface to operate over the full external voltage. This prevents hardware damage and communication errors due to voltage level differences.

While operation is recommended from 3.3V to 5.0V, the transceiver can operate down to 2.5V.

Pin Assignments

1	GND	GND	44
2	NC	ANTENNA	43
3	GND	GND	42
4	NC	NC	41
5	NC	NC	40
6	GND	GND	39
7	NC	DATA_IN	38
8	NC	DATA_OUT	37
9	TRPT/PKT	NC	36
10	CHN_SELO	NC	35
11	GND	GND	34
12	CHN_SEL1	NC	33
13	CHN_SEL2	NC	32
14	LVL_ADJ	CMD_DATA_BAUD	31
15	READY	CMD_DATA_TYPE	30
16	NC	CMD_DATA_OUT	29
17	GND	GND	28
18	T/R_SEL	CMD_DATA_IN	27
19	BAUD0	STANDBY	26
20	BAUD1	VCC	25
21	RSSI	POWER_DOWN	24
22	GND	GND	23

Figure 21: NT Series Transceiver Pinout (Top View)

Pin Descriptions

Pin Descriptions		
Pin Number	Name	Description
1, 3, 6, 11, 17, 22, 23, 28, 34, 39, 42, 44	GND	Ground
2, 4, 5, 7, 8, 16, 32, 33, 35, 36, 40, 41	NC	No Connection
9	TRPT / PKT ^{1,2}	Transparent/Packet Data Select. Pull high or float.

Pin Descriptions		
Pin Number	Name	Description
10	CHN_SELO ¹	Parallel Channel Select 0
12	CHN_SEL1 ¹	Parallel Channel Select 1
13	CHN_SEL2 ¹	Parallel Channel Select 2
14	LVL_ADJ ¹	Level Adjust. This line sets the transmitter output power level. Pull high or leave open for the highest power; connect to GND through a resistor to lower the power.
15	READY	Ready. This line is low when the transceiver is ready to communicate and high when it is busy. This line can be used for hardware handshaking on the command port.
18	T/R_SEL ¹	Transmit/Receive Select. Pull this line low to place the transceiver into receive mode. Pull it high to place it into transmit mode.
19	BAUD0 ¹	Baud Rate Select 0. This line and BAUD1 set the over-the-air data rate and filter bandwidths.
20	BAUD1 ¹	Baud Rate Select 1. This line and BAUD0 set the over-the-air data rate and filter bandwidths.
21	RSSI	Received Signal Strength Indicator. This line outputs an analog voltage that is proportional to the strength of the received signal. Updated once a second.
24	POWER_DOWN	Power Down. Pulling this line low places the module into a low-power state. The module will not be functional in this state. Pull high for normal operation.
25	VCC	Supply Voltage
26	STANDBY ¹	Standby. Pull this line high or leave floating to put the module into low-power standby mode. Pull to GND for normal operation.
27	CMD_DATA_IN ²	Command Data In. Pull high for normal operation.
29	CMD_DATA_OUT ²	Command Data Out. Do not connect for normal operation.
30	CMD_DATA_TYPE ²	Command Data Type. Pull low for normal operation.
31	CMD_DATA_BAUD ²	Command Data Baud. Pull low for normal operation.
37	DATA_OUT	Received Data Output. This line outputs the demodulated digital data.
38	DATA_IN	Transmit Data Input. This line accepts the data to be transmitted.
43	ANTENNA	50-ohm RF Antenna Port

1. These lines have an internal 100kΩ pull-up resistor
2. Contact Linx for more information

Figure 22: NT Series Transceiver Pin Descriptions

Sending Data

The NT Series transceiver module has two interfaces for sending data. One interface uses a UART to pass data in and out of the module. The modules put the data into a packet and take care of the transmission, reception and error check. This is a very low level over-the-air protocol and does not have any networking capabilities built in, but these capabilities can be added in a microcontroller outside the module. This interface and the protocol are detailed in RG-101 (NT Series Command Data Interface Reference Guide) and RG-102 (NT Series Transceiver Wireless UART Reference Guide).

This guide details the modules transparent interface. Through this interface the module does not encode or packetize the data in any manner. The data present on the DATA_IN line is used to modulate the transmitter. The received data is output on the DATA_OUT line and the transmit/receive state is controlled with the T/\bar{R} _SEL line. This transparency gives the designer great freedom in software and protocol development, allowing the creation of unique and proprietary data structures. This mode also allows the use of PWM and non-standard baud rate data.

The $\overline{\text{READY}}$ line outputs a logic low when the module is ready for use and logic high when it is busy. It can be used as hardware flow control to send streaming data and ensure that data is not missed.

The Data Input

Transmit Mode is enabled when the T/\bar{R} _SEL line is logic high. The data on the DATA_IN line is transmitted over the air. The DATA_IN line may be directly connected to virtually any digital peripheral, including microcontrollers and encoders. It can be used with any data that transitions from 0V to V_{CC} peak amplitude within the specified data rate range of the selected baud band. While it is possible to send data at higher rates, the internal filters will cause severe roll-off and attenuation.

Many RF products require a fixed data rate or place tight constraints on the mark/space ratio of the data being sent. The transceiver architecture eliminates such considerations and allows virtually any signal, including PWM, Manchester, and NRZ data, to be sent at rates from 1kbps to 300kbps.

The Data Output

Receive Mode is enabled when the T/\bar{R} _SEL line is logic low. The demodulated data is output on the DATA_OUT line. Like the DATA_IN line, this line may be directly connected to virtually any digital peripheral such as a microcontroller or decoder.

It is important to note that the transceiver does not provide squelching of the DATA_OUT line when in receive mode. This means that in the absence of a valid transmission, the DATA_OUT line switches randomly. This noise can be handled in software by implementing a noise tolerant protocol as described in Linx Application Note AN-00160 (Figure 44).

Using the RSSI Line

The receiver's Received Signal Strength Indicator (RSSI) line serves a variety of functions. This line has a dynamic range of 64dB and outputs a voltage proportional to the incoming signal strength. The RSSI Voltage vs. Input Power graph in the Typical Performance Graphs section shows the relationship between the RSSI voltage and the incoming signal power. This voltage is updated once a second. This line has a high impedance and an external buffer may be required for some applications.

It should be noted that the RSSI levels and dynamic range will vary from part to part. It is also important to remember that RSSI output indicates the strength of any in-band RF energy and not necessarily just that from the intended transmitter; therefore, it should be used only to qualify the presence and level of a signal. Using RSSI to determine distance or data validity is not recommended.

The RSSI output can be utilized during testing or even as a product feature to assess interference and channel quality by looking at the RSSI level with all intended transmitters shut off. The RSSI output can also be used in direction-finding applications, although there are many potential perils to consider in such systems. Finally, it can be used to save system power by "waking up" external circuitry when a transmission is received or crosses a certain threshold. The RSSI output feature adds tremendous versatility for the creative designer.

Using the T/R_SEL Input

The transmit/receive select (T/R_SEL) line is used to switch the transceiver between transmit and receive mode. If it is pulled low, the transceiver exits transmit mode and enters receive mode. Alternatively, if the line is pulled high, the transceiver exits receive mode and enters transmit mode. The $\overline{\text{READY}}$ output switches high during the change and returns low when the module is ready to receive or transmit data. None of the other operating modes are affected by the change. The data rate and channel settings remain as set.

Using the Low Power Features

The Power Down ($\overline{\text{POWER_DOWN}}$) line can be used to completely power down the transceiver module without the need for an external switch. This line allows easy control of the transceiver power state from external components, such as a microcontroller. The module is not functional while in power down mode.

Similar to the $\overline{\text{POWER_DOWN}}$ line, the Standby (STANDBY) line can be used to put the transceiver into a low-power sleep mode. This line has an internal pull-up, so when it is held high or left floating, the transceiver enters a low power (2.6mA) state. When the STANDBY line is pulled to ground, the module is fully active. During Standby, all operating modes are deactivated. The $\overline{\text{READY}}$ output is high during standby.

Standby has a higher current consumption than Power Down but a faster wake-up time. By periodically activating the transceiver, sending data, then powering down or entering standby, the transceiver's average current consumption can be greatly reduced, saving power in battery-operated applications.

 **Warning:** Pulling any of the module inputs high while in Power Down can partially activate the module, increasing current consumption and potentially placing it into an indeterminate state that could lead to unpredictable operation. Pull all inputs low before pulling $\overline{\text{POWER_DOWN}}$ low to prevent this issue. Lines that may be hardwired (for example, the BAUD lines) can be connected to the $\overline{\text{POWER_DOWN}}$ line so that they are lowered when $\overline{\text{POWER_DOWN}}$ is lowered.

Using the $\overline{\text{READY}}$ Output

The Ready ($\overline{\text{READY}}$) line can be used to monitor the status of the module. It is logic high while the transceiver is busy and logic low when the transceiver is ready to transmit or receive data. This allows the line to be used as hardware flow control. It is logic high when in Standby, but is logic low in Power Down since the entire module is off.

Using the LVL_ADJ Line

The Level Adjust (LVL_ADJ) line allows the transceiver's output power to be easily adjusted for range control, lower power consumption or to meet legal requirements. This is done by placing a resistor to ground on LVL_ADJ to form a voltage divider with an internal 100k Ω resistor. When the transceiver powers up, the voltage on this line is measured and the output power level is set accordingly. When LVL_ADJ is connected to V_{CC} or floating, the output power and current consumption are the highest. When connected to ground, the output power and current are the lowest. The power is digitally controlled in 58 steps providing approximately 0.5dB per step. See the Typical Performance Graphs section (Figures 5–19) for a graph of the output power vs. LVL_ADJ resistance.

 **Warning:** The LVL_ADJ line uses a resistor divider to create a voltage that determines the output power. Any additional current sourcing or sinking can change this voltage and result in a different power level. The power level should be checked to confirm that it is set as expected.

This line is very useful during regulatory testing to compensate for antenna gain or other product-specific issues that may cause the output power to exceed legal limits. A variable resistor to ground can be temporarily used so that the test lab can precisely adjust the output power to the maximum level allowed by law. The variable resistor's value can be noted and a fixed resistor substituted for final testing. Even in designs where attenuation is not anticipated, it is a good idea to place resistor pads connected to LVL_ADJ and ground so that it can be used if needed. Figure 23 on the following page shows the 1% tolerance resistor value that is needed to activate each power level.

Power Level vs. Resistor Value								
Power Level	P _o (dBm)	1% Resistor Value	Power Level	P _o (dBm)	1% Resistor Value	Power Level	P _o (dBm)	1% Resistor value
57	12.22	Open	38	3.49	154k	19	-5.47	44.2k
56	12.12	750k	37	3.11	143k	18	-5.78	41.2k
55	12.14	649k	36	2.77	133k	17	-6.12	37.4k
54	11.86	576k	35	2.12	127k	16	-6.72	34.8k
53	11.85	510k	34	1.65	118k	15	-7.09	32.4k
52	9.58	453k	33	1.16	111k	14	-7.52	29.4k
51	9.78	412k	32	0.81	105k	13	-7.91	26.7k
50	8.94	347k	31	0.38	97.6k	12	-8.36	24.3k
49	8.33	340k	30	-0.18	91k	11	-8.83	22k
48	8.02	316k	29	-0.66	86.6k	10	-9.39	19.6k
47	7.42	287k	28	-0.93	80.6k	9	-9.13	17.4k
46	6.99	267k	27	-1.46	76.8k	8	-9.68	15.4k
45	6.72	243k	26	-1.84	71.5k	7	-10.23	13.3k
44	6.33	226k	25	-2.39	66.5k	6	-10.86	11.3k
43	5.80	210k	24	-2.83	62k	5	-11.50	9.53k
42	5.38	200k	23	-3.27	57.6k	4	-12.23	7.5k
41	4.83	182k	22	-3.79	54.9k	3	-13.04	5.76k
40	4.33	174k	21	-4.30	51k	2	-13.98	4.02k
39	4.05	165k	20	-4.85	47k	1	-14.59	2.32k
						0	-15.78	750

Figure 23: NT Series Transceiver Power Level vs. Resistor Value

Baud Band Selection

There are two baud select lines (BAUD0 and BAUD1) that configure the transceiver for the desired over-the-air data rate. The two baud select lines choose among four baud bands, or ranges of data rate and IF bandwidth, as shown in Figure 24.

Setting the baud band appropriately for the desired baud rate configures the internal filters and circuitry for optimal performance at that rate. Data can be sent in at a lower rate than specified for the band, but the sensitivity, and therefore range, will not be as good as in a lower setting. Data can also be sent in faster than specified by the band, but the internal filters will cause distortion of the data stream and range will be significantly reduced.

Baud Band Selection					
Baud Band	BAUD1	BAUD0	Baud Rate (kbps)	IF Bandwidth (kHz)	Receiver Sensitivity (dBm)
1	0	0	1 to 19.2	100	-113
2	0	1	19.2 to 80	150	-110
3	1	0	80 to 160	200	-106
4	1	1	160 to 300	300	-102

Figure 24: NT Series Transceiver Baud Band Selection

Channel Selection

The transceiver allows for setting the channel frequency with the CHN_SEL0, CHN_SEL1 and CHN_SEL2 lines in a parallel manner. The logic states of the three lines select from among eight channels. This allows the channel to be set by DIP switches, microcontroller lines or hardwired. The 868MHz channels are shown in Figure 25 and the 900MHz channels are shown in Figure 26.

868MHz Channel Selection				
CHN_SEL2	CHN_SEL1	CHN_SEL0	CHANNEL	FREQUENCY
0	0	0	0	863.15
0	0	1	10	864.15
0	1	0	20	865.15
0	1	1	30	866.15
1	0	0	52	868.35
1	0	1	58	868.95
1	1	0	64	869.55
1	1	1	67	869.85

Figure 25: NT Series Transceiver 868MHz Channel Selection

900MHz Channel Selection				
CHN_SEL2	CHN_SEL1	CHN_SEL0	CHANNEL	FREQUENCY
0	0	0	3	903.37
0	0	1	15	906.37
0	1	0	21	907.87
0	1	1	27	909.37
1	0	0	39	912.37
1	0	1	51	915.37
1	1	0	69	919.87
1	1	1	75	921.37

Figure 26: NT Series Transceiver 900MHz Channel Selection

European Transmission Rules

While the FCC does not have any requirements other than power and harmonic levels for the 900MHz band, European rules are more complicated. The 863 to 870MHz band is subdivided into other bands that are designated for specific applications. These sub bands can be used for generic devices provided they meet one of two requirements.

The first requirement is duty cycle, which is defined as the amount of time the transmitter is on per hour. The duty cycle is different for the different bands and ranges from 0.1% to 10%.

The other option is that the transmitter implement Listen-Before-Talk (LBT) optionally combined with Adaptive Frequency Agility (AFA). This basically means that the transmitter will listen to a channel to be sure that it is clear before transmitting (LBT). If the channel is occupied by another transmitter, then it will wait until the channel is clear or change to another channel to transmit its data (AFA).

The NT Series does not implement LBT or AFA, but these features can be added to a microcontroller outside the module. Implementing these eliminates the need to track the transmit time to ensure compliance with the duty cycle limits.

Figure 27 lists the 868MHz channels and their duty cycle requirements if LBT is not implemented. It is recommended that the designer review ETSI EN 300 220-1 for the full requirements.

868MHz Channel Selection					
Channel	Frequency	D.C.	Channel	Frequency	D.C.
0	863.15	0.10%	34	866.55	0.10%
1	863.25	0.10%	35	866.65	0.10%
2	863.35	0.10%	36	866.75	0.10%
3	863.45	0.10%	37	866.85	0.10%
4	863.55	0.10%	38	866.95	0.10%
5	863.65	0.10%	39	867.05	0.10%
6	863.75	0.10%	40	867.15	0.10%
7	863.85	0.10%	41	867.25	0.10%
8	863.95	0.10%	42	867.35	0.10%
9	864.05	0.10%	43	867.45	0.10%
10	864.15	0.10%	44	867.55	0.10%
11	864.25	0.10%	45	867.65	0.10%
12	864.35	0.10%	46	867.75	0.10%
13	864.45	0.10%	47	867.85	0.10%
14	864.55	0.10%	48	867.95	0.10%
15	864.65	0.10%	49	868.05	1%
16	864.75	0.10%	50	868.15	1%
17	864.85	0.10%	51	868.25	1%
18	864.95	0.10%	52	868.35	1%
19	865.05	0.10%	53	868.45	1%
20	865.15	0.10%	54	868.55	1%
21	865.25	0.10%	55	868.65	0.10%
22	865.35	0.10%	56	868.75	0.10%
23	865.45	0.10%	57	868.85	0.10%
24	865.55	0.10%	58	868.95	0.10%
25	865.65	0.10%	59	869.05	0.10%
26	865.75	0.10%	60	869.15	0.10%
27	865.85	0.10%	61	869.25	0.10%
28	865.95	0.10%	62	869.35	0.10%
29	866.05	0.10%	63	869.45	10%
30	866.15	0.10%	64	869.55	10%
31	866.25	0.10%	66	869.75	None/ 1%*
32	866.35	0.10%	67	869.85	None/ 1%*
33	866.45	0.10%	68	869.95	None / 1%*

* No duty cycle limit at 5mW max power, 1% limit at 25mW max power.
Dark Gray = Hardware Selectable Channels

Figure 27: NT Series Transceiver 868MHz Serial Channels and Duty Cycle Requirements

Figure 28 shows the 900MHz channels available through the module's serial Command Data Interface.

NT Series Transceiver 900MHz Serial Channels							
Channel	Frequency	Channel	Frequency	Channel	Frequency	Channel	Frequency
0	902.62	26	909.12	51	915.37	76	921.62
1	902.87	27	909.37	52	915.62	77	921.87
2	903.12	28	909.62	53	915.87	78	922.12
3	903.37	29	909.87	54	916.12	79	922.37
4	903.62	30	910.12	55	916.37	80	922.62
5	903.87	31	910.37	56	916.62	81	922.87
6	904.12	32	910.62	57	916.87	82	923.12
7	904.37	33	910.87	58	917.12	83	923.37
8	904.62	34	911.12	59	917.37	84	923.62
9	904.87	35	911.37	60	917.62	85	923.87
10	905.12	36	911.62	61	917.87	86	924.12
11	905.37	37	911.87	62	918.12	87	924.37
12	905.62	38	912.12	63	918.37	88	924.62
13	905.87	39	912.37	64	918.62	89	924.87
14	906.12	40	912.62	65	918.87	90	925.12
15	906.37	41	912.87	66	919.12	91	925.37
16	906.62	42	913.12	67	919.37	92	925.62
17	906.87	43	913.37	68	919.62	93	925.87
18	907.12	44	913.62	69	919.87	94	926.12
19	907.37	45	913.87	70	920.12	95	926.37
20	907.62	46	914.12	71	920.37	96	926.62
21	907.87	47	914.37	72	920.62	97	926.87
22	908.12	48	914.62	73	920.87	98	927.12
23	908.37	49	914.87	74	921.12	99	927.37
24	908.62	50	915.12	75	921.37	100	927.62
25	908.87						

Dark Gray = Hardware Selectable Channels

Figure 28: NT Series Transceiver 900MHz Serial Channels

Typical Applications

Figure 29 shows a circuit using the NT Series transceiver.

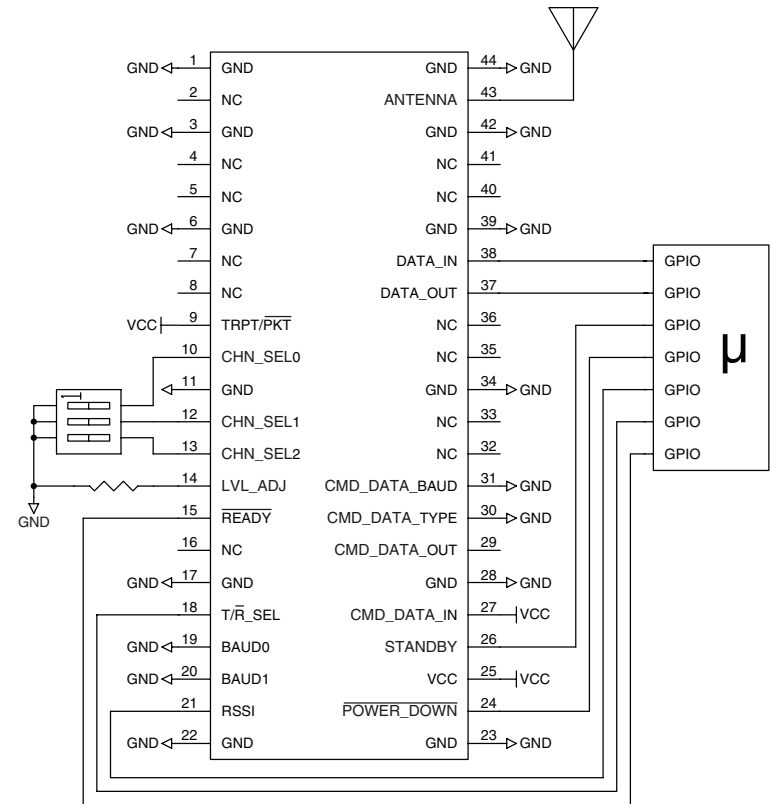

Figure 29: NT Series Transceiver Typical Application

The channel select lines are controlled with a DIP switch, so changing the switches changes the channel. DATA_IN and DATA_OUT are connected to GPIOs on a microcontroller that generates and decodes the over-the-air data. $\overline{\text{READY}}$ and RSSI are monitored by the microcontroller and $\overline{\text{T/R_SEL}}$, $\overline{\text{POWER_DOWN}}$ and STANDBY are controlled by the microcontroller. The BAUD lines are tied low, placing the module into a single baud band (19.2kbps). This circuit allows the microcontroller to monitor and control the power state of the module while the end user manually selects the channel.

Power Supply Requirements

The transceiver incorporates a precision low-dropout regulator which allows operation over a wide input voltage range. Despite this regulator, it is still important to provide a supply that is free of noise. Power supply noise can significantly affect the module's performance, so providing a clean power supply for the module should be a high priority during design.

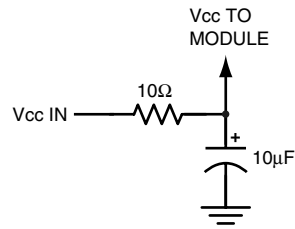

Figure 30: Supply Filter

A 10Ω resistor in series with the supply followed by a 10μF tantalum capacitor from V_{CC} to ground will help in cases where the quality of supply power is poor (Figure 30). This filter should be placed close to the module's supply lines. These values may need to be adjusted depending on the noise present on the supply line.

Antenna Considerations

The choice of antennas is a critical and often overlooked design consideration. The range, performance and legality of an RF link are critically dependent upon the antenna. While adequate antenna performance can often be obtained by trial and error methods, antenna design and matching is a complex task. Professionally designed antennas such as those from Linx (Figure 31) will help ensure maximum performance and FCC and other regulatory compliance.



Figure 31: Linx Antennas

Linx transmitter modules typically have an output power that is higher than the legal limits. This allows the designer to use an inefficient antenna such as a loop trace or helical to meet size, cost or cosmetic requirements and still achieve full legal output power for maximum range. If an efficient antenna is used, then some attenuation of the output power will likely be needed. This can easily be accomplished by using the LVL_ADJ line.

It is usually best to utilize a basic quarter-wave whip until your prototype product is operating satisfactorily. Other antennas can then be evaluated based on the cost, size and cosmetic requirements of the product. Additional details are in Application Note AN-00500 (Figure 47).

The transceiver includes a U.FL connector as well as a line for the antenna connection. This offers the designer a great deal of flexibility in antenna selection and location within the end product. Linx offers cable assemblies with a U.FL connector on one end and several types of standard and FCC-compliant reverse-polarity connectors on the other end. Alternatively, the designer may wish to use the pin and route the antenna to a PCB mount connector or even a printed loop trace antenna. This gives the designer the greatest ability to optimize performance and cost within the design.

Note: Either the connector or the line can be used for the antenna, but not both at the same time.

Protocol Guidelines

While many RF solutions impose data formatting and balancing requirements, the transparent modes of Linx RF modules do not encode or packetize the signal content in any manner. The received signal will be affected by such factors as noise, edge jitter and interference, but it is not purposefully manipulated or altered by the modules. This gives the designer tremendous flexibility for custom protocol design and interface.

Despite this transparency and ease of use, it must be recognized that there are distinct differences between a wired and a wireless environment. Issues such as interference and contention must be understood and allowed for in the design process. To learn more about protocol considerations see Linx Application Note AN-00160 (Figure 47).

Errors from interference or changing signal conditions can cause corruption of the data packet, so it is generally wise to structure the data being sent into small packets. This allows errors to be managed without affecting large amounts of data. A simple checksum or CRC could be used for basic error detection. Once an error is detected, the protocol designer may wish to simply discard the corrupt data or implement a more sophisticated scheme to correct it.

Interference Considerations

The RF spectrum is crowded and the potential for conflict with other unwanted sources of RF is very real. While all RF products are at risk from interference, its effects can be minimized by better understanding its characteristics.

Interference may come from internal or external sources. The first step is to eliminate interference from noise sources on the board. This means paying careful attention to layout, grounding, filtering and bypassing in order to eliminate all radiated and conducted interference paths. For many products, this is straightforward; however, products containing components such as switching power supplies, motors, crystals and other potential sources of noise must be approached with care. Comparing your own design with a Linx evaluation board can help to determine if and at what level design-specific interference is present.

External interference can manifest itself in a variety of ways. Low-level interference will produce noise and hashing on the output and reduce the link's overall range.

High-level interference is caused by nearby products sharing the same frequency or from near-band high-power devices. It can even come from your own products if more than one transmitter is active in the same area. It is important to remember that only one transmitter at a time can occupy a frequency, regardless of the coding of the transmitted signal. This type of interference is less common than those mentioned previously, but in severe cases it can prevent all useful function of the affected device.

Although technically not interference, multipath is also a factor to be understood. Multipath is a term used to refer to the signal cancellation effects that occur when RF waves arrive at the receiver in different phase relationships. This effect is a particularly significant factor in interior environments where objects provide many different signal reflection paths. Multipath cancellation results in lowered signal levels at the receiver and shorter useful distances for the link.

Pad Layout

The pad layout diagram in Figure 32 is designed to facilitate both hand and automated assembly.

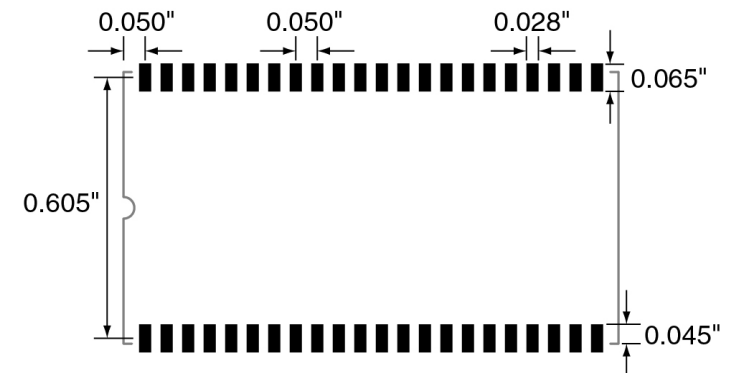

Figure 32: Recommended PCB Layout

Board Layout Guidelines

The module's design makes integration straightforward; however, it is still critical to exercise care in PCB layout. Failure to observe good layout techniques can result in a significant degradation of the module's performance. A primary layout goal is to maintain a characteristic 50-ohm impedance throughout the path from the antenna to the module. Grounding, filtering, decoupling, routing and PCB stack-up are also important considerations for any RF design. The following section provides some basic design guidelines which may be helpful.

During prototyping, the module should be soldered to a properly laid-out circuit board. The use of prototyping or "perf" boards will result in poor performance and is strongly discouraged. Likewise, the use of sockets can have a negative impact on the performance of the module and are discouraged.

The module should, as much as reasonably possible, be isolated from other components on your PCB, especially high-frequency circuitry such as crystal oscillators, switching power supplies, and high-speed bus lines.

When possible, separate RF and digital circuits into different PCB regions. Make sure internal wiring is routed away from the module and antenna and is secured to prevent displacement.

Do not route PCB traces directly under the module. There should not be any copper or traces under the module on the same layer as the module, just bare PCB. The underside of the module has traces and vias that could short or couple to traces on the product's circuit board.

The Pad Layout section shows a typical PCB footprint for the module. A ground plane (as large and uninterrupted as possible) should be placed on a lower layer of your PC board opposite the module. This plane is essential for creating a low impedance return for ground and consistent stripline performance.

Use care in routing the RF trace between the module and the antenna or connector. Keep the trace as short as possible. Do not pass it under the module or any other component. Do not route the antenna trace on multiple PCB layers as vias will add inductance. Vias are acceptable for tying together ground layers and component grounds and should be used in multiples.

Each of the module's ground pins should have short traces tying immediately to the ground plane through a via.

Bypass caps should be low ESR ceramic types and located directly adjacent to the pin they are serving.

A 50-ohm coax should be used for connection to an external antenna. A 50-ohm transmission line, such as a microstrip, stripline or coplanar waveguide should be used for routing RF on the PCB. The Microstrip Details section provides additional information.

In some instances, a designer may wish to encapsulate or "pot" the product. There are a wide variety of potting compounds with varying dielectric properties. Since such compounds can considerably impact RF performance and the ability to rework or service the product, it is the responsibility of the designer to evaluate and qualify the impact and suitability of such materials.

Microstrip Details

A transmission line is a medium whereby RF energy is transferred from one place to another with minimal loss. This is a critical factor, especially in high-frequency products like Linx RF modules, because the trace leading to the module's antenna can effectively contribute to the length of the antenna, changing its resonant bandwidth. In order to minimize loss and detuning, some form of transmission line between the antenna and the module should be used unless the antenna can be placed very close (<1/8in) to the module. One common form of transmission line is a coax cable and another is the microstrip. This term refers to a PCB trace running over a ground plane that is designed to serve as a transmission line between the module and the antenna. The width is based on the desired characteristic impedance of the line, the thickness of the PCB and the dielectric constant of the board material. For standard 0.062in thick FR-4 board material, the trace width would be 111 mils. The correct trace width can be calculated for other widths and materials using the information in Figure 33 and examples are provided in Figure 34. Software for calculating microstrip lines is also available on the Linx website.

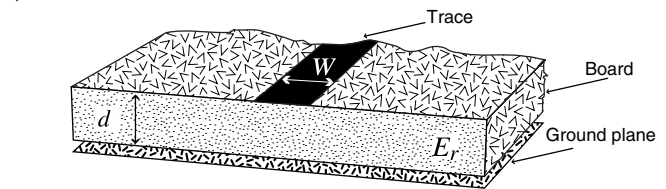

$$E_e = \frac{E_r + 1}{2} + \frac{E_r - 1}{2} \cdot \frac{1}{\sqrt{1 + 12d/W}}$$

$$Z_0 = \begin{cases} \frac{60}{\sqrt{E_e}} \cdot \ln\left(\frac{8d}{W} + \frac{W}{4d}\right) & \text{For } \frac{W}{d} \leq 1 \\ \frac{120\pi}{\sqrt{E_e} \cdot \left(\frac{W}{d} + 1.393 + 0.667 \cdot \ln\left(\frac{W}{d} + 1.444\right)\right)} & \text{For } \frac{W}{d} \geq 1 \end{cases}$$

E_r = Dielectric constant of PCB material

Figure 33: Microstrip Formulas

Example Microstrip Calculations			
Dielectric Constant	Width / Height Ratio (W / d)	Effective Dielectric Constant	Characteristic Impedance (Ω)
4.80	1.8	3.59	50.0
4.00	2.0	3.07	51.0
2.55	3.0	2.12	48.8

Figure 34: Example Microstrip Calculations

Production Guidelines

The module is housed in a hybrid SMD package that supports hand and automated assembly techniques. Since the modules contain discrete components internally, the assembly procedures are critical to ensuring the reliable function of the modules. The following procedures should be reviewed with and practiced by all assembly personnel.

Hand Assembly

Pads located on the bottom of the module are the primary mounting surface (Figure 35). Since these pads are inaccessible during mounting, castellations that run up the side of the module have been provided to facilitate solder wicking to the module's underside. This allows for very

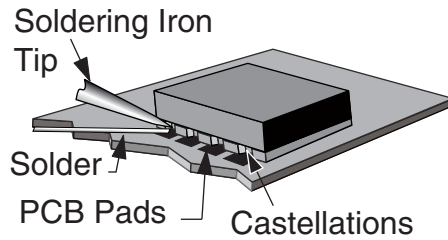

Figure 35: Soldering Technique

quick hand soldering for prototyping and small volume production. If the recommended pad guidelines have been followed, the pads will protrude slightly past the edge of the module. Use a fine soldering tip to heat the board pad and the castellation, then introduce solder to the pad at the module's edge. The solder will wick underneath the module, providing reliable attachment. Tack one module corner first and then work around the device, taking care not to exceed the times in Figure 36.

Warning: Pay attention to the absolute maximum solder times.

Absolute Maximum Solder Times

Hand Solder Temperature: +427°C for 10 seconds for lead-free alloys

Reflow Oven: +255°C max (see Figure 37)

Figure 36: Absolute Maximum Solder Times

Automated Assembly

For high-volume assembly, the modules are generally auto-placed. The modules have been designed to maintain compatibility with reflow processing techniques; however, due to their hybrid nature, certain aspects of the assembly process are far more critical than for other component types. Following are brief discussions of the three primary areas where caution must be observed.

Reflow Temperature Profile

The single most critical stage in the automated assembly process is the reflow stage. The reflow profile in Figure 37 should not be exceeded because excessive temperatures or transport times during reflow will irreparably damage the modules. Assembly personnel need to pay careful attention to the oven's profile to ensure that it meets the requirements necessary to successfully reflow all components while still remaining within the limits mandated by the modules. The figure below shows the recommended reflow oven profile for the modules.

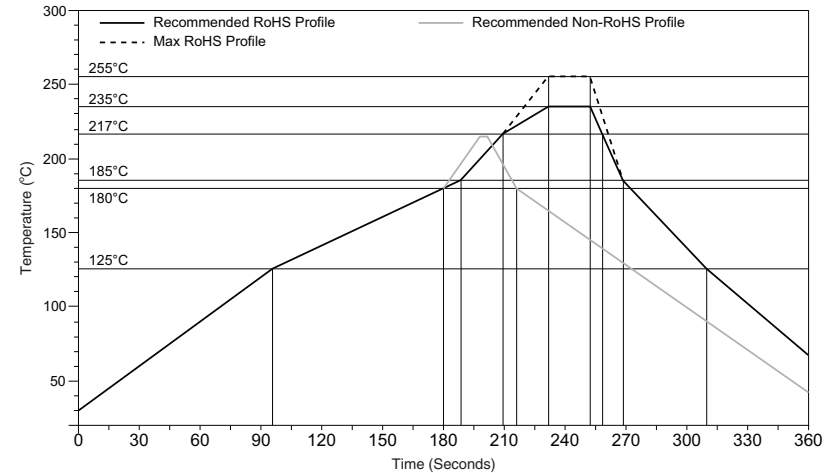

Figure 37: Maximum Reflow Temperature Profile

Shock During Reflow Transport

Since some internal module components may reflow along with the components placed on the board being assembled, it is imperative that the modules not be subjected to shock or vibration during the time solder is liquid. Should a shock be applied, some internal components could be lifted from their pads, causing the module to not function properly.

Washability

The modules are wash-resistant, but are not hermetically sealed. Linx recommends wash-free manufacturing; however, the modules can be subjected to a wash cycle provided that a drying time is allowed prior to applying electrical power to the modules. The drying time should be sufficient to allow any moisture that may have migrated into the module to evaporate, thus eliminating the potential for shorting damage during power-up or testing. If the wash contains contaminants, the performance may be adversely affected, even after drying.

General Antenna Rules

The following general rules should help in maximizing antenna performance.

1. Proximity to objects such as a user's hand, body or metal objects will cause an antenna to detune. For this reason, the antenna shaft and tip should be positioned as far away from such objects as possible.
2. Optimum performance is obtained from a $\frac{1}{4}$ - or $\frac{1}{2}$ -wave straight whip mounted at a right angle to the ground plane (Figure 38). In many cases, this isn't desirable for practical or ergonomic reasons, thus, an alternative antenna style such as a helical, loop or patch may be utilized and the corresponding sacrifice in performance accepted.

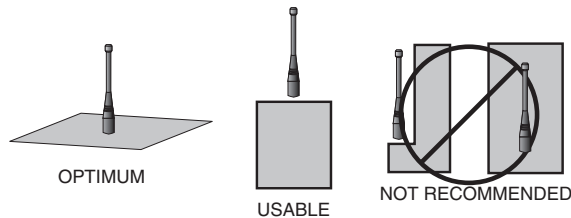

Figure 38: Ground Plane Orientation

3. If an internal antenna is to be used, keep it away from other metal components, particularly large items like transformers, batteries, PCB tracks and ground planes. In many cases, the space around the antenna is as important as the antenna itself. Objects in close proximity to the antenna can cause direct detuning, while those farther away will alter the antenna's symmetry.
4. In many antenna designs, particularly $\frac{1}{4}$ -wave whips, the ground plane acts as a counterpoise, forming, in essence, a $\frac{1}{2}$ -wave dipole (Figure 39). For this reason, adequate ground plane area is essential. The ground plane can be a metal case or ground-fill areas on a circuit board. Ideally, it should have a surface area less than or equal to the overall length of the $\frac{1}{4}$ -wave radiating element. This is often not practical due to size and configuration constraints. In these instances, a designer must make the best use of the area available to create as much ground

VERTICAL $\lambda/4$ GROUNDED ANTENNA (MARCONI)

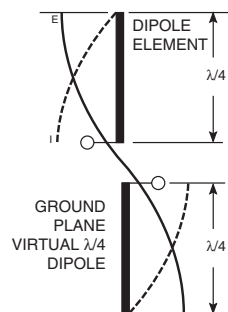

Figure 39: Dipole Antenna

plane as possible in proximity to the base of the antenna. In cases where the antenna is remotely located or the antenna is not in close proximity to a circuit board, ground plane or grounded metal case, a metal plate may be used to maximize the antenna's performance.

5. Remove the antenna as far as possible from potential interference sources. Any frequency of sufficient amplitude to enter the receiver's front end will reduce system range and can even prevent reception entirely. Switching power supplies, oscillators or even relays can also be significant sources of potential interference. The single best weapon against such problems is attention to placement and layout. Filter the module's power supply with a high-frequency bypass capacitor. Place adequate ground plane under potential sources of noise to shunt noise to ground and prevent it from coupling to the RF stage. Shield noisy board areas whenever practical.
6. In some applications, it is advantageous to place the module and antenna away from the main equipment (Figure 40). This can avoid interference problems and allows the antenna to be oriented for optimum performance. Always use 50Ω coax, like RG-174, for the remote feed.

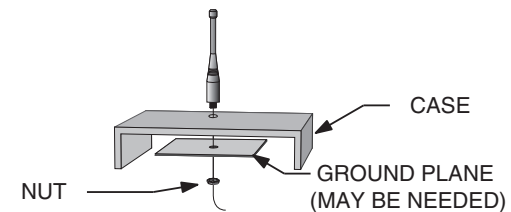

Figure 40: Remote Ground Plane

Common Antenna Styles

There are hundreds of antenna styles and variations that can be employed with Linx RF modules. Following is a brief discussion of the styles most commonly utilized. Additional antenna information can be found in Linx Application Notes AN-00100, AN-00140, AN-00500 and AN-00501. Linx antennas and connectors offer outstanding performance at a low price.

Whip Style

A whip style antenna (Figure 41) provides outstanding overall performance and stability. A low-cost whip can be easily fabricated from a wire or rod, but most designers opt for the consistent performance and cosmetic appeal of a professionally-made model. To meet this need, Linx offers a wide variety of straight and reduced height whip style antennas in permanent and connectorized mounting styles.



Figure 41: Whip Style Antennas

The wavelength of the operational frequency determines an antenna's overall length. Since a full wavelength is often quite long, a partial 1/2- or 1/4-wave antenna is normally employed. Its size and natural radiation resistance make it well matched to Linx modules. The proper length for a straight 1/4-wave can be easily determined using the formula in Figure 42. It is also possible to reduce the overall height of the antenna by using a helical winding. This reduces the antenna's bandwidth but is a great way to minimize the antenna's physical size for compact applications. This also means that the physical appearance is not always an indicator of the antenna's frequency.

$$L = \frac{234}{F_{\text{MHz}}}$$

Figure 42:
L = length in feet of quarter-wave length
F = operating frequency in megahertz

Specialty Styles

Linx offers a wide variety of specialized antenna styles (Figure 43). Many of these styles utilize helical elements to reduce the overall antenna size while maintaining reasonable performance. A helical antenna's bandwidth is often quite narrow and the antenna can detune in proximity to other objects, so care must be exercised in layout and placement.



Figure 43: Specialty Style Antennas

Loop Style

A loop or trace style antenna is normally printed directly on a product's PCB (Figure 44). This makes it the most cost-effective of antenna styles. The element can be made self-resonant or externally resonated with discrete components, but its actual layout is usually product specific. Despite the cost advantages, loop style antennas are generally inefficient and useful only for short range applications. They are also very sensitive to changes in layout and PCB dielectric, which can cause consistency issues during production. In addition, printed styles are difficult to engineer, requiring the use of expensive equipment including a network analyzer. An improperly designed loop will have a high VSWR at the desired frequency which can cause instability in the RF stage.



Figure 44: Loop or Trace Antenna

Linx offers low-cost planar (Figure 45) and chip antennas that mount directly to a product's PCB. These tiny antennas do not require testing and provide excellent performance despite their small size. They offer a preferable alternative to the often problematic "printed" antenna.



Figure 45: SP Series "Splatch" Antenna

Regulatory Considerations

Note: Linx RF modules are designed as component devices that require external components to function. The purchaser understands that additional approvals may be required prior to the sale or operation of the device, and agrees to utilize the component in keeping with all laws governing its use in the country of operation.

When working with RF, a clear distinction must be made between what is technically possible and what is legally acceptable in the country where operation is intended. Many manufacturers have avoided incorporating RF into their products as a result of uncertainty and even fear of the approval and certification process. Here at Linx, our desire is not only to expedite the design process, but also to assist you in achieving a clear idea of what is involved in obtaining the necessary approvals to legally market a completed product.

For information about regulatory approval, read AN-00142 on the Linx website or call Linx. Linx designs products with worldwide regulatory approval in mind.

In the United States, the approval process is actually quite straightforward. The regulations governing RF devices and the enforcement of them are the responsibility of the Federal Communications Commission (FCC). The regulations are contained in Title 47 of the United States Code of Federal Regulations (CFR). Title 47 is made up of numerous volumes; however, all regulations applicable to this module are contained in Volume 0-19. It is strongly recommended that a copy be obtained from the FCC's website, the Government Printing Office in Washington or from your local government bookstore. Excerpts of applicable sections are included with Linx evaluation kits or may be obtained from the Linx Technologies website, www.linxtechnologies.com. In brief, these rules require that any device that intentionally radiates RF energy be approved, that is, tested for compliance and issued a unique identification number. This is a relatively painless process. Final compliance testing is performed by one of the many independent testing laboratories across the country. Many labs can also provide other certifications that the product may require at the same time, such as UL, CLASS A / B, etc. Once the completed product has passed, an ID number is issued that is to be clearly placed on each product manufactured.

Questions regarding interpretations of the Part 2 and Part 15 rules or the measurement procedures used to test intentional radiators such as Linx RF modules for compliance with the technical standards of Part 15 should be addressed to:

Federal Communications Commission
Equipment Authorization Division
Customer Service Branch, MS 1300F2
7435 Oakland Mills Road
Columbia, MD, US 21046
Phone: + 1 301 725 585 | Fax: + 1 301 344 2050
Email: labinfo@fcc.gov

ETSI Secretaria
650, Route des Lucioles
06921 Sophia-Antipolis Cedex
FRANCE
Phone: +33 (0)4 92 94 42 00
Fax: +33 (0)4 93 65 47 16

International approvals are slightly more complex, although Linx modules are designed to allow all international standards to be met. If the end product is to be exported to other countries, contact Linx to determine the specific suitability of the module to the application.

All Linx modules are designed with the approval process in mind and thus much of the frustration that is typically experienced with a discrete design is eliminated. Approval is still dependent on many factors, such as the choice of antennas, correct use of the frequency selected and physical packaging. While some extra cost and design effort are required to address these issues, the additional usefulness and profitability added to a product by RF makes the effort more than worthwhile.

Achieving a Successful RF Implementation

Adding an RF stage brings an exciting new dimension to any product. It also means that additional effort and commitment will be needed to bring the product successfully to market. By utilizing pre-made RF modules the design and approval process is greatly simplified. It is still important, however, to have an objective view of the steps necessary to ensure a successful RF integration. Since the capabilities of each customer vary widely, it is difficult to recommend one particular design path, but most projects follow steps similar to those shown in Figure 46.

In reviewing this sample design path, you may notice that Linx offers a variety of services (such as antenna design and FCC pre-qualification) that are unusual for a high-volume component manufacturer. These services, along with an exceptional level of technical support, are offered because we recognize that RF is a complex science requiring the highest caliber of products and support. “Wireless Made Simple” is more than just a motto: it’s our commitment. By choosing Linx as your RF partner and taking advantage of the resources we offer, you will not only survive implementing RF, you may even find the process enjoyable.

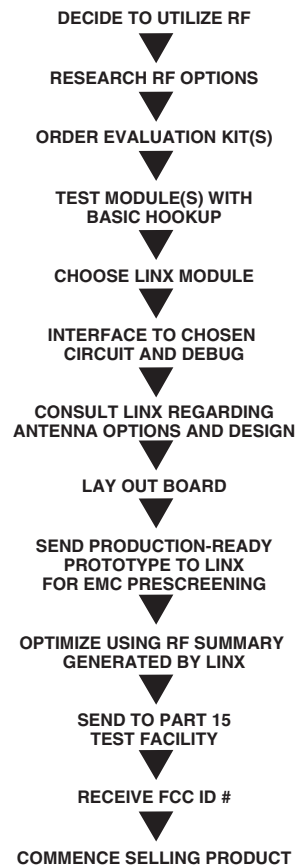

Figure 46: Typical Steps for Implementing RF

Helpful Application Notes From Linx

It is not the intention of this manual to address in depth many of the issues that should be considered to ensure that the modules function correctly and deliver the maximum possible performance. As you proceed with your design, you may wish to obtain one or more of the following application notes which address in depth key areas of RF design and application of Linx products. These applications notes are available online at www.linxtechnologies.com or by contacting the Linx literature department.

Helpful Application Note Titles	
Note Number	Note Title
AN-00100	RF 101: Information for the RF Challenged
AN-00126	Considerations for Operation Within the 902–928MHz Band
AN-00130	Modulation Techniques for Low-Cost RF Data Links
AN-00140	The FCC Road: Part 15 from Concept to Approval
AN-00160	Considerations for Sending Data Over a Wireless Link
AN-00500	Antennas: Design, Application, Performance
AN-00501	Understanding Antenna Specifications and Operation

Figure 47: Helpful Application Note Titles



Linx Technologies
159 Ort Lane
Merlin, OR, US 97532

Phone: +1 541 471 6256
Fax: +1 541 471 6251

www.linxtechnologies.com

Disclaimer

Linx Technologies is continually striving to improve the quality and function of its products. For this reason, we reserve the right to make changes to our products without notice. The information contained in this Data Guide is believed to be accurate as of the time of publication. Specifications are based on representative lot samples. Values may vary from lot-to-lot and are not guaranteed. "Typical" parameters can and do vary over lots and application. Linx Technologies makes no guarantee, warranty, or representation regarding the suitability of any product for use in any specific application. It is the customer's responsibility to verify the suitability of the part for the intended application. **NO LINX PRODUCT IS INTENDED FOR USE IN ANY APPLICATION WHERE THE SAFETY OF LIFE OR PROPERTY IS AT RISK.**

Linx Technologies **DISCLAIMS ALL WARRANTIES OF MERCHANTABILITY AND FITNESS FOR A PARTICULAR PURPOSE. IN NO EVENT SHALL LINX TECHNOLOGIES BE LIABLE FOR ANY OF CUSTOMER'S INCIDENTAL OR CONSEQUENTIAL DAMAGES ARISING IN ANY WAY FROM ANY DEFECTIVE OR NON-CONFORMING PRODUCTS OR FOR ANY OTHER BREACH OF CONTRACT BY LINX TECHNOLOGIES.** The limitations on Linx Technologies' liability are applicable to any and all claims or theories of recovery asserted by Customer, including, without limitation, breach of contract, breach of warranty, strict liability, or negligence. Customer assumes all liability (including, without limitation, liability for injury to person or property, economic loss, or business interruption) for all claims, including claims from third parties, arising from the use of the Products. The Customer will indemnify, defend, protect, and hold harmless Linx Technologies and its officers, employees, subsidiaries, affiliates, distributors, and representatives from and against all claims, damages, actions, suits, proceedings, demands, assessments, adjustments, costs, and expenses incurred by Linx Technologies as a result of or arising from any Products sold by Linx Technologies to Customer. Under no conditions will Linx Technologies be responsible for losses arising from the use or failure of the device in any application, other than the repair, replacement, or refund limited to the original product purchase price. Devices described in this publication may contain proprietary, patented, or copyrighted techniques, components, or materials. Under no circumstances shall any user be conveyed any license or right to the use or ownership of such items.

©2018 Linx Technologies. All rights reserved.

The stylized Linx logo, Wireless Made Simple, WISE, CipherLinx and the stylized CL logo are trademarks of Linx Technologies.