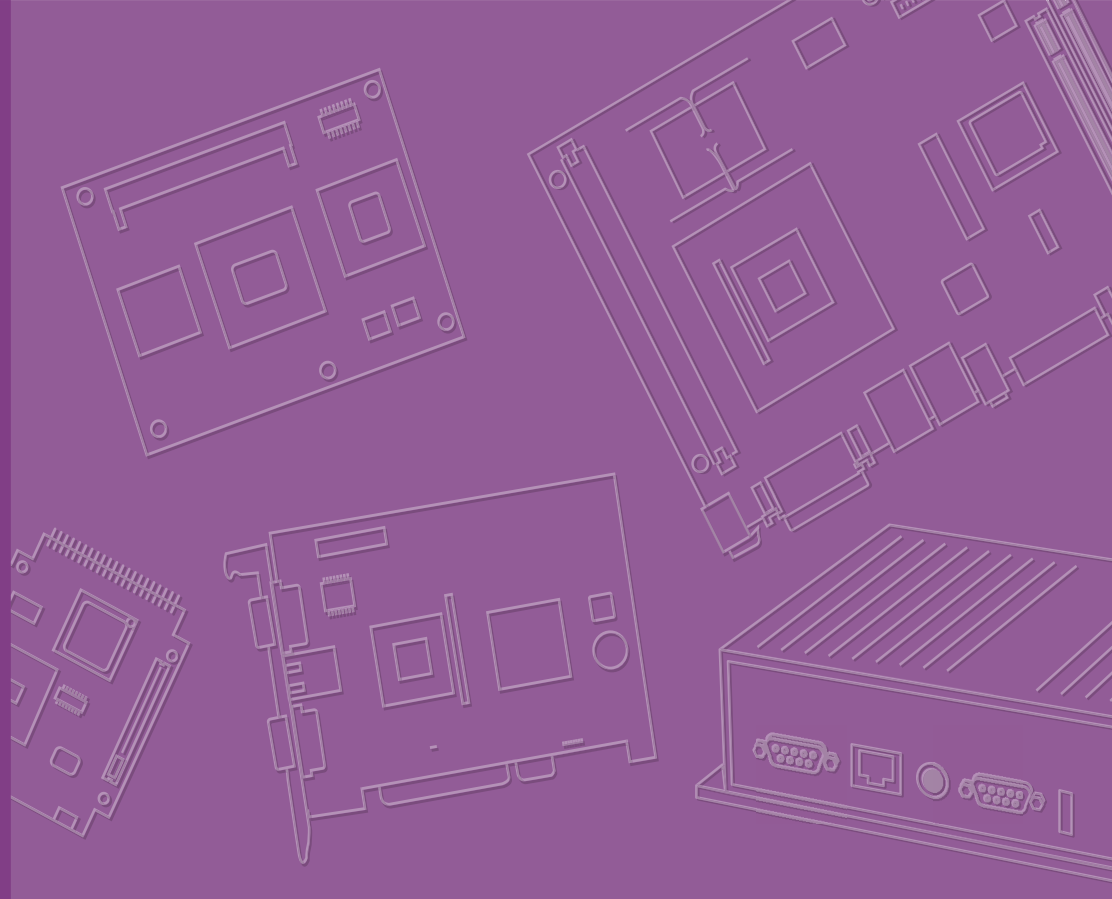




**User Manual**



## **AIMB-275**

**Intel® Core™ i7/i5/i3/Pentium/  
Celeron LGA1151 Mini-ITX with  
CRT/LVDS/HDMI/DP++, 2 COM,  
Dual LAN, PCIe x16, 12 ~ 24 V  
DCIN**

**ADVANTECH**

*Enabling an Intelligent Planet*

---

## Copyright

The documentation and the software included with this product are copyrighted 2016 by Advantech Co., Ltd. All rights are reserved. Advantech Co., Ltd. reserves the right to make improvements in the products described in this manual at any time without notice.

No part of this manual may be reproduced, copied, translated or transmitted in any form or by any means without the prior written permission of Advantech Co., Ltd. Information provided in this manual is intended to be accurate and reliable. However, Advantech Co., Ltd. assumes no responsibility for its use, nor for any infringements of the rights of third parties, which may result from its use.

## Acknowledgements

IBM and PC are trademarks of International Business Machines Corporation.

Intel® Core™ i7/i5/i3, Pentium, Celeron® is trademark of Intel Corporation

All other product names or trademarks are properties of their respective owners.

# A Message to the Customer

## Advantech Customer Services

Each and every Advantech product is built to the most exacting specifications to ensure reliable performance in the harsh and demanding conditions typical of industrial environments. Whether your new Advantech equipment is destined for the laboratory or the factory floor, you can be assured that your product will provide the reliability and ease of operation for which the name Advantech has come to be known. Your satisfaction is our primary concern. Here is a guide to Advantech's customer services. To ensure you get the full benefit of our services, please follow the instructions below carefully.

## Technical Support

We want you to get the maximum performance from your products. So if you run into technical difficulties, we are here to help. For the most frequently asked questions, you can easily find answers in your product documentation. These answers are normally a lot more detailed than the ones we can give over the phone.

So please consult this manual first. If you still cannot find the answer, gather all the information or questions that apply to your problem, and with the product close at hand, call your dealer. Our dealers are well trained and ready to give you the support you need to get the most from your Advantech products. In fact, most problems reported are minor and are able to be easily solved over the phone.

In addition, free technical support is available from Advantech engineers every business day. We are always ready to give advice on application requirements or specific information on the installation and operation of any of our products.

---

# Declaration of Conformity

## FCC Class B

This device complies with the requirements in part 15 of the FCC rules:

Operation is subject to the following two conditions:

- This device may not cause harmful interference
- This device must accept any interference received, including interference that may cause undesired operation.

This equipment has been tested and found to comply with the limits for a Class B digital device, pursuant to Part 15 of the FCC Rules. These limits are designed to provide reasonable protection against harmful interference when the equipment is operated in a commercial environment. This equipment generates, uses, and can radiate radio frequency energy and, if not installed and used in accordance with the instruction manual, may cause harmful interference to radio communications. Operation of this device in a residential area is likely to cause harmful interference in which case the user will be required to correct the interference at his/her own expense. The user is advised that any equipment changes or modifications not expressly approved by the party responsible for compliance would void the compliance to FCC regulations and therefore, the user's authority to operate the equipment.

**Caution!** *There is a danger of a new battery exploding if it is incorrectly installed. Do not attempt to recharge, force open, or heat the battery. Replace the battery only with the same or equivalent type recommended by the manufacturer. Discard used batteries according to the manufacturer's instructions.*



## CPU Compatibility

Processor_Number	Max Frequency Speed	Cache	ES/QS/MP	Lithography
i7-6700	3.4GHz	8MB	MP	14nm
i5-6600	3.3GHz	6MB	MP	14nm
i5-6500	3.2GHz	6MB	MP	14nm
i7-6700TE	2.4GHz	8MB	MP	14nm
i5-6500TE	2.3GHz	6MB	MP	14nm
i3-6100	3.7GHz	4MB	QS	14nm
i3-6100TE	2.7GHz	4MB	QS	14nm
G4400	3.3GHz	2MB	MP	14nm

## Memory Compatibility

Category	Speed (MHz)	Capacity	Vendor	Chip_PN	ECG ANTECH PN
DDR4	2133	16G	Trandscend	SEC 534 K4A8G08 5WB BCPB	AQD-SD4U16E21-SE
DDR4	2133	8G	Trandscend	SEC 452 BCPB K4A4G085WD	AQD-SD4U8GE21-SG
DDR4	2133	8G	Trandscend	SEC 449 BCPB K4A4G085WD	AQD-SD4U8GN21-SG
DDR4	2133	8G	ATP	A4F08QG8BLPBME/40A77	N/A
DDR4	2133	8G	ADATA	H5AN8G8NMFR TFC	N/A
DDR4	2133	4G	Trandscend	SEC 501 BCPB K4A4G085WD	AQD-SD4U4GN21-SG
DDR4	2133	4G	ATP	40A77 D9RGQ	N/A
DDR4	2133	4G	ADATA	H5AN4G8NMFR TFC	N/A
DDR4	2133	4G	Innodisk	SEC 446 BCPB K4A4G085WD	N/A

## Ordering Information

P/N	Chipset	DP	VGA	LVDS/ eDP	HDMI	GbE LAN	COM	SATAIII	SATA DOM	USB3.0/ 2.0	M.2	MiniP-Cle	PClex 16	TPM	AMP
AIMB-275G2-00A1E	Q170	1	1	1 / (1)	1 (2.0)	2	2	2	1	6 / 4	1	1 (F/S)	1	(1)	(1)
AIMB-275VG-00A1E	Q170	1	1	0	1 (1.2)	1	2	2	0	4 / 4	0	1 (F/S)	1	(1)	(1)
AIMB-275L-00A1E	H110	1	1	0	1 (1.2)	1	2	2	0	4 / 4	0	1 (F/S)	1	(1)	(1)

\*( ) BOM options available on MP version

---

## Product Warranty (2 years)

Advantech warrants to you, the original purchaser, that each of its products will be free from defects in materials and workmanship for two years from the date of purchase.

This warranty does not apply to any products which have been repaired or altered by persons other than repair personnel authorized by Advantech, or which have been subject to misuse, abuse, accident or improper installation. Advantech assumes no liability under the terms of this warranty as a consequence of such events.

Because of Advantech's high quality-control standards and rigorous testing, most of our customers never need to use our repair service. If an Advantech product is defective, it will be repaired or replaced at no charge during the warranty period. For out-of-warranty repairs, you will be billed according to the cost of replacement materials, service time and freight. Please consult your dealer for more details.

If you think you have a defective product, follow these steps:

1. Collect all the information about the problem encountered. (For example, CPU speed, Advantech products used, other hardware and software used, etc.) Note anything abnormal and list any onscreen messages you get when the problem occurs.
2. Call your dealer and describe the problem. Please have your manual, product, and any helpful information readily available.
3. If your product is diagnosed as defective, obtain an RMA (return merchandise authorization) number from your dealer. This allows us to process your return more quickly.
4. Carefully pack the defective product, a fully-completed Repair and Replacement Order Card and a photocopy proof of purchase date (such as your sales receipt) in a shippable container. A product returned without proof of the purchase date is not eligible for warranty service.
5. Write the RMA number visibly on the outside of the package and ship it prepaid to your dealer.

## Initial Inspection

Before you begin installing your motherboard, please make sure that the following materials have been shipped:

- 1 x AIMB-275 Intel Core™ i7/i5/i3 LGA1151 Mini-ITX motherboard
- 1 x SATA HDD cable
- 1 x SATA Power cable
- 1 x Serial port cable
- 1 x I/O port bracket
- 1 x 3-to-20 Pin ATX Power cable
- 1 x Startup manual
- 1 x Warranty card

If any of these items are missing or damaged, contact your distributor or sales representative immediately. We have carefully inspected the AIMB-275 mechanically and electrically before shipment. It should be free of marks and scratches and in perfect working order upon receipt. As you unpack the AIMB-275, check it for signs of shipping damage. (For example, damaged box, scratches, dents, etc.) If it is damaged or it fails to meet the specifications, notify our service department or your local sales representative immediately. Also notify the carrier. Retain the shipping carton and packing material for inspection by the carrier. After inspection, we will make arrangements to repair or replace the unit.





# Contents

## Chapter 1 General Information .....1

1.1	Introduction .....	2
1.2	Features .....	2
1.3	Specifications .....	2
1.3.1	System .....	2
1.3.2	Memory .....	2
1.3.3	Input/Output .....	2
1.3.4	Graphics.....	3
1.3.5	Ethernet LAN .....	3
1.3.6	Industrial features .....	3
1.3.7	Mechanical and environmental specifications.....	3
1.4	Jumpers and Connectors .....	4
	Table 1.1: Connector and Header List.....	4
	Table 1.2: Jumper List.....	5
1.5	Board layout: Jumper and Connector Locations .....	5
	Figure 1.1 Jumper and Connector Location (Top Side).....	5
	Figure 1.2 Jumper and Connector Location (Bottom Side) .....	6
1.6	AIMB-275 Board Diagram .....	7
	Figure 1.3 AIMB-275 Board Diagram .....	7
1.7	Safety Precautions .....	8
1.8	Jumper Settings .....	8
1.8.1	How to Set Jumpers.....	8
1.8.2	CMOS Clear (CMOS1) .....	9
	Table 1.3: CMOS1 .....	9
1.8.3	Power Switch/HDD LED/SMBUS/Speaker Pin Header (JFP1) ....	9
	Table 1.4: Power Switch/HDD LED/SMBUS/Speaker Pin Header (JFP1).....	9
1.8.4	Power LED and Keyboard Lock Pin Header (JFP2).....	9
	Table 1.5: Power LED and Keyboard Lock Pin Header (JFP2)...	9
1.8.5	Watchdog Timer Output and OBS Beep (JWDT1+JOBS1).....	10
	Table 1.6: Watchdog Timer Output and OBS Beep (JWDT1+JOBS1).....	10
1.8.6	ATX/AT Mode Selection (PSON1).....	10
	Table 1.7: ATX/AT Mode Selection (PSON1).....	10
1.8.7	LVDS Panel Voltage Selection (JLVDS1).....	11
	Table 1.8: LVDS Panel Voltage Selection (JLVDS1) .....	11
1.8.8	COM2 RI# Pin RI#/5V/12V Select (JSETCOM2_V1) .....	11
	Table 1.9: COM2 RI# Pin RI#/5V/12V Select (JSETCOM2_V1)11	
1.9	System Memory .....	11
1.10	Memory Installation Procedures.....	12
1.11	Cache Memory.....	12
1.12	Processor Installation.....	12

## Chapter 2 Connecting Peripherals .....13

2.1	Introduction .....	14
2.2	USB Ports (LAN1_USB12/LAN2_USB34/USB56/USB78/USB910).....	14
	Table 2.1: LAN LED Indicator.....	14
2.3	VGA Connector(VGA1) .....	15
2.4	Serial Ports (COM1~COM2) .....	16
2.5	PS/2 Keyboard and Mouse Connector (KBMS1) .....	17
2.6	CPU Fan Connector (CPU_FAN1).....	17
2.7	System FAN Connector (SYSFAN1/2).....	18
2.8	Power Switch/HDD LED/SMBUS/Speaker Pin Header (JFP1) & Power	

	LED and Keyboard Lock Pin Header (JFP2) .....	19
2.8.1	ATX soft power switch (JFP1/PWR_SW) .....	19
2.8.2	Reset (JFP1/RESET).....	19
2.8.3	HDD LED (JFP1/HDDLED) .....	19
2.8.4	External speaker (JFP1/SPEAKER).....	19
2.8.5	Power LED and keyboard lock connector (JFP2/PWR_LED & KEY LOCK).....	20
	Table 2.2: ATX power supply LED status (No support for AT power).....	20
2.9	Display Port and HDMI Common Connector (DP-HDMI1) .....	20
2.10	DC Input Phoenix Connector (DCIN1).....	21
2.11	SATA Signal Connector (SATA1 ~ SATA3).....	21
2.12	SATA_PWR1/2 .....	22
2.13	HD Analog Audio Interface (AUDIO1, FPAUD1) .....	22
2.14	PCI-E x16 Slot (PCIEX16_1) .....	23
2.15	LVDS Panel Connector (LVDS1).....	23
2.16	LVDS Backlight Inverter Power Connector (INV1).....	24
2.17	Embedded Display Port Connector (EDP1), BOM optional .....	25
2.18	MINIPCIE and mSATA Connector (MINIPCIE1).....	25
2.19	Front Next Generation Form Factor (M.2_1) .....	26
2.20	HD Digital Audio Interface (SPDIF1).....	26
2.21	Audio Amplifier Output Connector (AMP1), BOM optional .....	27
2.22	General Purpose I/O Pin Header (GPIO1).....	27
2.23	SPI BIOS Flash Socket (SPI1).....	28
2.24	SPI Programming Pin Header (SPI_CN1) .....	28
2.25	Low Pin Count Header (LPC1) .....	29
2.26	Case-Open Detect Connector (JCASE1).....	29
2.27	ATX 12V Power Supply Connector (ATX12V1) & ATX Power Supply Connector (ATXPWR1).....	30
2.28	Battery Holder (BAT1).....	30
2.29	CPU Socket (CPU1) .....	31
2.30	DDR4 SO-DIMM Socket (DIMMA1, DIMMB1).....	31

## **Chapter 3 BIOS Operation ..... 33**

3.1	Introduction .....	34
3.2	BIOS Setup .....	34
3.2.1	Main Menu .....	34
3.2.2	Advanced BIOS Features .....	35
3.2.3	Chipset Configuration Setting .....	65
3.2.4	Security Setting.....	82
3.2.5	Boot Setting .....	84
3.2.6	Save & Exit Configuration.....	85

## **Chapter 4 Software Introduction & Service ..... 87**

4.1	Introduction .....	88
4.2	Value-Added Software Services .....	88
4.2.1	Software API.....	88
4.2.2	Software Utility.....	90

## **Chapter 5 Chipset Software Installation Utility 91**

5.1	Before You Begin.....	92
5.2	Introduction .....	92

<b>Chapter 6</b>	<b>USB Setup .....</b>	<b>95</b>
6.1	Introduction .....	96
6.2	Win 7 / 8 USB 3.0 Driver installation .....	96
<b>Chapter 7</b>	<b>VGA Setup .....</b>	<b>99</b>
7.1	Introduction .....	100
7.2	Windows 7/8/10 VGA Driver Installation .....	100
<b>Chapter 8</b>	<b>LAN Configuration.....</b>	<b>103</b>
8.1	Introduction .....	104
8.2	Features .....	104
8.3	Installation .....	104
8.4	Windows® 7/8/10 Driver Setup (Intel I219LM / I211AT) .....	105
<b>Appendix A</b>	<b>I/O Pin Assignments.....</b>	<b>107</b>
A.1	DC input Phoenix Connector (DCIN1) .....	108
A.2	COM Port (COM1) .....	108
A.3	Video Graphics Array Connector (VGA1) .....	108
A.4	DisplayPort + High Definition Multimedia Interface (DP1+HDMI1) .....	109
A.5	RJ45+USB 3.0 Stack Connector (LAN1_USB12) RJ45+USB 3.0 Stack Connector (LAN2_USB34) .....	110
A.6	HD Analog Audio Interface (AUDIO1).....	111
A.7	Audio Amplifier Output Connector (AMP1) .....	111
A.8	Front HD Analog Audio Interface (FPAUD1).....	111
A.9	HD Digital Audio Interface (SPDIF1).....	112
A.10	PCI-E x16 Slot (PCIEX16_1) .....	112
A.11	SMBUS Programming INFINEON for +Vcore Controller (JSMB1) .....	114
A.12	CPU FAN Power Connector (CPUFAN1) .....	115
A.13	SYSTEM FAN Power Connector (SYSFAN2).....	115
A.14	SPI Programming Pin Header (SPI_CN1) .....	115
A.15	USB 3.0 Connector (USB56) .....	116
A.16	USB 2.0 Connector (USB78/ USB910).....	116
A.17	SPI BIOS Flash Socket (SPI1).....	116
A.18	SATA Signal Connector (SATA1/ 2) .....	117
A.19	SATA/SATA-DOM Signal Connector (SATA3) .....	117
A.20	General Purpose I/O Pin Header (GPIO1).....	118
A.21	Low Pin Count Header (LPC1).....	118
A.22	PS/2 Keyboard and Mouse Connector (KBMS1).....	118
A.23	ATX Power supply (5VSB) connector (ATX_5VSB1).....	119
A.24	MINIPCIE and mSATA Connector (MINI-PCIE1).....	119
A.25	COM Port (COM2) .....	120
A.26	eDP/LVDS Backlight Inverter Power Connector (INV1).....	121
A.27	Embedded Display Port Connector (EDP1).....	121
A.28	SYSTEM FAN Power Connector (SYSFAN1).....	122
A.29	SATA Power Connector (SATA_PWR1/ SATA_PWR2) .....	122
A.30	LVDS Panel Connector (LVDS1) .....	122
A.31	ATX 12V Power Supply Connector (ATX12V1) .....	123
A.32	Next Generation Form Factor (M.2_1).....	124
A.33	M.2 Screw_42*22mm & 42*30mm (M.2_2) M.2 Screw_80*22mm (M.2_3) .....	125
A.34	LVDS VESA, JEIDA format selection pin header (JLVDS_VCON1).....	125
A.35	Case open selection pin header (JCASEOP_SW1).....	126
A.36	Case-Open Detect Connector (JCASE1).....	126

---

A.37	Watchdog Timer Output and OBS Beep (JWDT1+JOBS1).....	126
A.38	SATA Power connector (JSATAPWR1).....	127

# Chapter 1

General Information

## 1.1 Introduction

AIMB-275 is designed with the Intel® Q170 PCH for industrial applications that require both performance computing and enhanced power management capabilities. The motherboard supports Intel desktop Core i7/i5/i3/Pentium/Celeron processor up to 8 MB L3 cache and 2 DDR4 2133MHz SO-DIMM, up to 32 GB. A rich I/O connectivity of 2 serial ports, 10 USB, dual GbE LAN, 3 SATA, 1 miniPCIe and 1 NGFF (M.2\_B Key) Connector.

## 1.2 Features

- **Rich I/O connectivity:** 2 serial ports, 6 USB 3.0, 4 USB 2.0, 3 SATA, 1 MINIP-CIE colay with MSATA, 1 M.2 NGFF connector, Dual GbE LAN and 1 PCIe x16
- **Standard Mini-ITX form factor with industrial feature:** The AIMB-275 is a full-featured Mini-ITX motherboard with balanced expandability and performance
- **Wide selection of storage devices:** SATA HDD, mSATA, M.2 (B key), customers benefit from the flexibility of using the most suitable storage device for larger capacity
- **Optimized integrated graphic solution:** With Intel® Graphics Flexible, it supports versatile display options and 32/64 bit 3D graphics engine

## 1.3 Specifications

### 1.3.1 System

- **CPU:** LGA1151 Intel desktop Core i7/i5/i3/Pentium/Celeron processors compliant
- **BIOS:** AMI EFI 128 Mbit SPI BIOS
- **System chipset:** Intel® Q170
- **SATA hard disk drive interface:**
  - Three on-board SATA connector with data transmission rate up to 600 MB

### 1.3.2 Memory

- **RAM:** 2 x 260-pins SODIMM socket support dual channel DDR4 2133MHz SDRAM, up to 32GB Max.

### 1.3.3 Input/Output

- **PCI bus:** 1 PCIe x16 slot
- **Serial ports:** Two serial ports, 1 x RS-232 & 1 x RS-232/422/485
- **Keyboard and PS/2 mouse connector:** Supports one standard PS/2 keyboard, one standard PS/2 mouse
- **USB port:** Supports up to ten USB ports with transmission rate up to 625 MB, 6 on board pin header with USB 3.0 and 4 external ports with USB 2.0

**Note!** *Under Window 7 OS, all of USB 2.0/3.0 ports are not workable before XHCI driver is installed. Suggest to use PS/2 keyboard & mouse for XHCI driver install first.*



- **GPIO connector:** 8-bit general purpose Input/Output

### 1.3.4 Graphics

- **Controller:** Intel® HD graphics
- **Display memory:** 1 GB maximum shared memory with 2GB and above system memory installed
- **VGA:** Supports VGA up to resolution 1920 x 1200 @ 60 Hz refresh rate
- **LVDS:** Supports LVDS up to resolution 1920 x 1200
- **HDMI:** Supports HDMI up to resolution 4096 x 2304 @ 60Hz
- **Displayport1.2:** Supports Display port up to resolution 3840 x 2160 @ 60Hz
- **eDP:** Supports up to resolution 4096 x 2160 @ 60Hz

### 1.3.5 Ethernet LAN

- Supports dual 10/100/1000 Mbps Ethernet port (s) via PCI Express x1 bus which provides 500 MB/s data transmission rate
- **Controller:** LAN1: Intel i219LM; LAN2: Intel i211AT

### 1.3.6 Industrial features

- **Watchdog timer:** Can generate a system reset. The watchdog timer is programmable, with each unit equal to one second or one minute (255 levels)

### 1.3.7 Mechanical and environmental specifications

- **Operating temperature:** 0 ~ 60° C (32 ~ 140° F, Depending on CPU)
- **Storage temperature:** -40 ~ 85° C (-40 ~ 185° F)
- **Humidity:** 5 ~ 95% non-condensing
- **Power supply voltage:** 12~24V DC Input
- **Power consumption:**  
Intel Core i7-6700 3.4GHz, 2pcs 16GB DDR4 2133MHz SDRAM, 24V @4.45A  
Measure the maximum current value which system under maximum load (CPU: Top speed, RAM & Graphic: Full loading)
- **Board size:** 170 mm x 170 mm (6.69" x 6.69")
- **Board weight:** 0.365 kg

## 1.4 Jumpers and Connectors

Connectors on the AIMB-275 motherboard link it to devices such as hard disk drives and a keyboard. In addition, the board has a number of jumpers used to configure your system for your application.

The tables below list the function of each of the board jumpers and connectors. Later sections in this chapter give instructions on setting jumpers. Chapter 2 gives instructions for connecting external devices to your motherboard.

**Table 1.1: Connector and Header List**

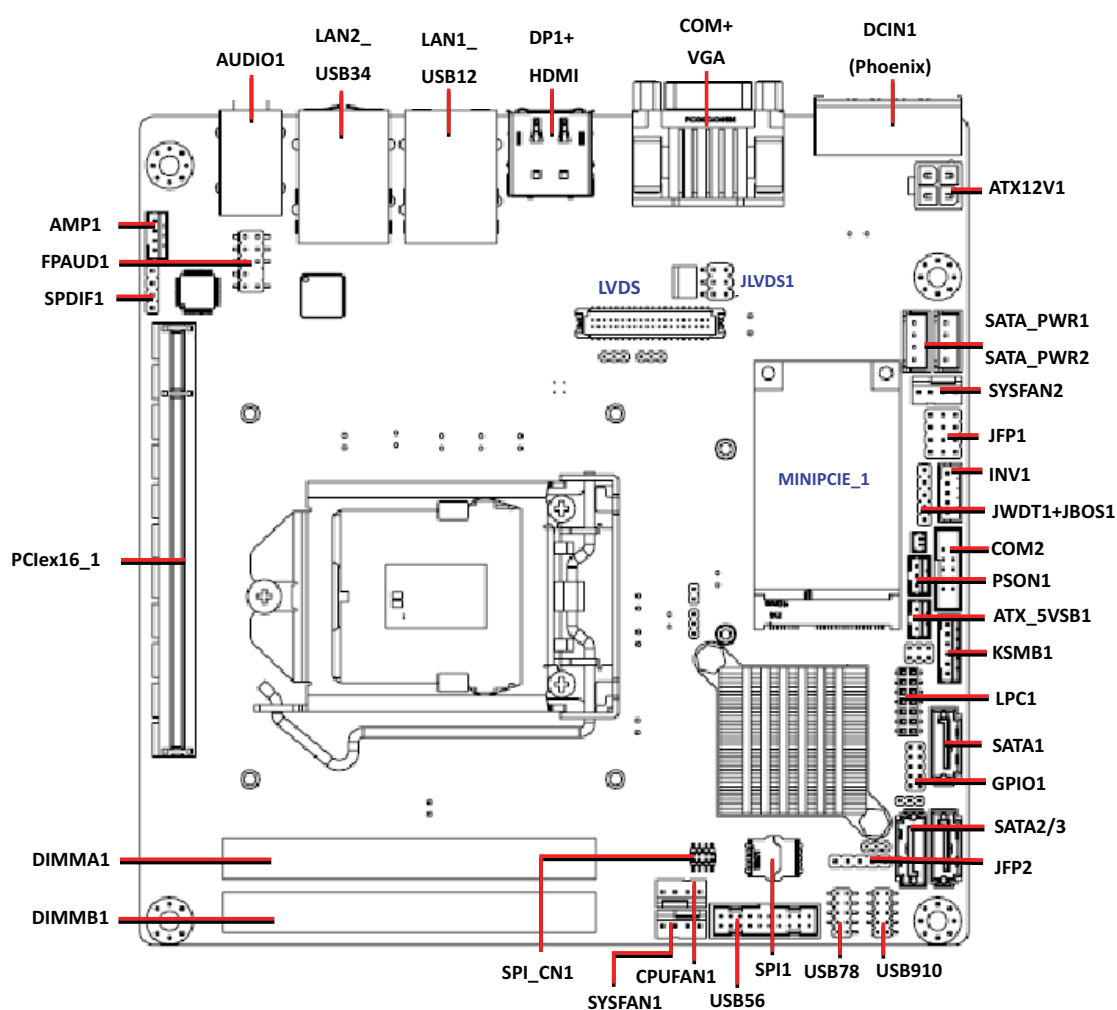
<b>Label</b>	<b>Function</b>
SATA1~SATA3	SATA Signal Connector
SATA_PWR1, SATA_PWR2	SATA Power Connector
MINIPCIE1	MINIPCIE and mSATA Connector
M.2_1	Next Generation Form Factor (M.2 B Key) Connector
M.2_3	NGFF (M.2) screw -80*22mm
M.2_2	NGFF (M.2) screw -42*22mm & 42*30mm
DP1+HDMI1	Display Port and HDMI Common Connector
VGA1	VGA Connector
LVDS1	LVDS Panel Connector
INV1	LVDS Backlight Inverter Power Connector
EDP1	Embedded Display Port Connector
USB56	USB 3.0 Pin Header
USB78, USB910	USB 2.0 Pin Header
LAN1_USB12, LAN2_USB34	RJ45+USB 3.0 Stack Connector
PCIEX16_1	PCI-E x16 Slot
SPDIF1	HD Digital Audio Interface
AUDIO1, FPAUD1	HD Analog Audio Interface
AMP1	Audio Amplifier Output Connector
GPIO1	General Purpose I/O Pin Header
SPI1	SPI BIOS Flash Socket
SPI_CN1	SPI Programming Pin Header
LPC1	Low Pin Count Header
JSMB1	SMBUS Programming I/F for Vcore Controller
JCASE1	Case-Open Detect Connector
KBMS1	PS/2 Keyboard and Mouse Connector
COM1, COM2	COM Port
CPUFAN1	CPU FAN Power Connector
SYSFAN1, SYSFAN2	SYSTEM FAN Power Connector
ATX12V1	ATX 12V Power Supply Connector
ATX_5VSB1	ATX Power supply (5VSB) connector
BAT1	Battery Holder
CPU1	CPU Socket
DIMMA1, DIMMB1	DDR4 SO-DIMM Socket



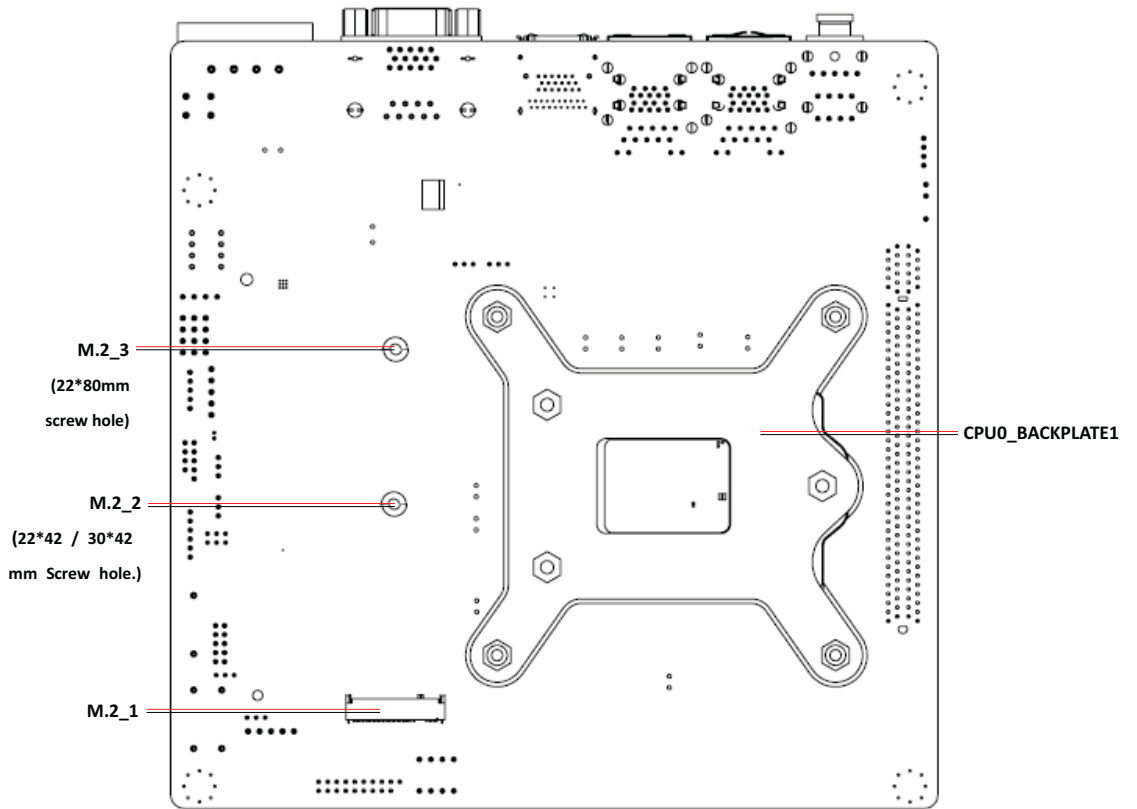
**Table 1.2: Jumper List**

Label	Function
CMOS1	CMOS Clear Jumper
JFP1	Power Switch/HDD LED/SMBUS/Speaker Pin Header
JFP2	Power LED and Keyboard Lock Pin Header
JWDT1+JOBS1	Watchdog Timer Output and OBS Beep
PSON1	ATX/AT Mode Selection
JLVDS1	LVDS Panel Voltage Selection
JCOM1	COM1 RI# pin RI#/5V/12V Select

## 1.5 Board layout: Jumper and Connector Locations

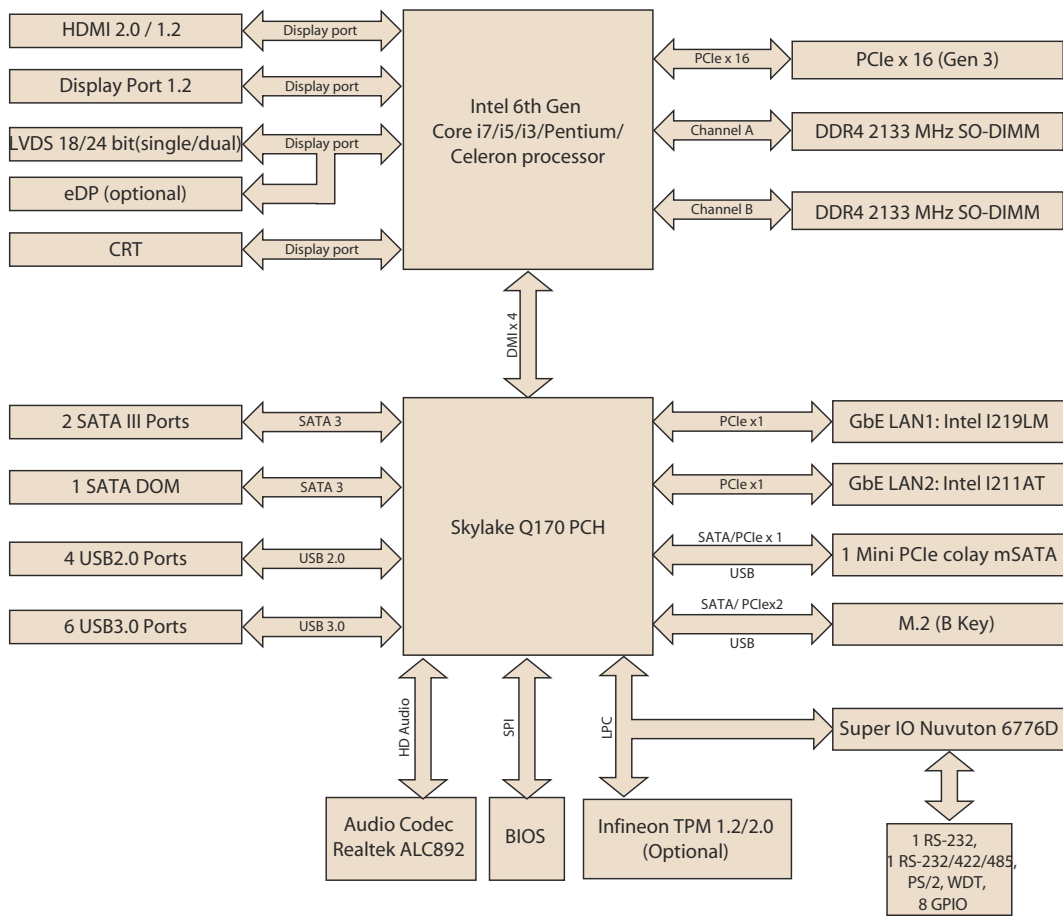


**Figure 1.1 Jumper and Connector Location (Top Side)**



**Figure 1.2 Jumper and Connector Location (Bottom Side)**

## 1.6 AIMB-275 Board Diagram



**Figure 1.3 AIMB-275 Board Diagram**

---

## 1.7 Safety Precautions

**Warning!** *Always completely disconnect the power cord from chassis whenever you work with the hardware. Do not make connections while the power is on. Sensitive electronic components can be damaged by sudden power surges. Only experienced electronics personnel should open the PC chassis.*



**Caution!** *Always ground yourself to remove any static charge before touching the motherboard. Modern electronic devices are very sensitive to electrostatic discharges. As a safety precaution, use a grounding wrist strap at all times. Place all electronic components on a static-dissipative surface or in a static-shielded bag when they are not in the chassis.*



**Caution!** *The computer is provided with a battery-powered real-time clock circuit. There is a danger of explosion if battery is incorrectly replaced. Replace only with same or equivalent type recommended by the manufacturer. Discard used batteries according to manufacturer's instructions.*



**Caution!** *There is a danger of a new battery exploding if it is incorrectly installed. Do not attempt to recharge, force open, or heat the battery. Replace the battery only with the same or equivalent type recommended by the manufacturer. Discard used batteries according to the manufacturer's instructions.*



## 1.8 Jumper Settings

This section provides instructions on how to configure your motherboard by setting the jumpers. It also includes the motherboards's default settings and your options for each jumper.


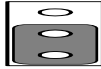
### 1.8.1 How to Set Jumpers

You can configure your motherboard to match the needs of your application by setting the jumpers. A jumper is a metal bridge that closes an electrical circuit. It consists of two metal pins and a small metal clip (often protected by a plastic cover) that slides over the pins to connect them. To “close” (or turn ON) a jumper, you connect the pins with the clip. To “open” (or turn OFF) a jumper, you remove the clip. Sometimes a jumper consists of a set of three pins, labeled 1, 2, and 3. In this case you connect either pins 1 and 2, or 2 and 3. A pair of needle-nose pliers may be useful when setting jumpers.

## 1.8.2 CMOS Clear (CMOS1)

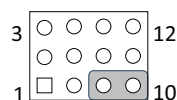
The AIMB-275 motherboard contains a jumper that can erase CMOS data and reset the system BIOS information. Normally this jumper should be set with pins 1-2 closed. If you want to reset the CMOS data, set CMOS1 to 2-3 closed for just a few seconds, and then move the jumper back to 1-2 closed. This procedure will reset the CMOS to its default setting.

**Table 1.3: CMOS1**

Function	Jumper Setting
	1    2    3
*Keep CMOS data	 <span style="margin-left: 10px;">1-2 closed</span>
	1    2    3
Clear CMOS data	 <span style="margin-left: 10px;">2-3 closed</span>

\* Default

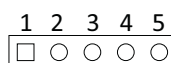
## 1.8.3 Power Switch/HDD LED/SMBUS/Speaker Pin Header (JFP1)



**Table 1.4: Power Switch/HDD LED/SMBUS/Speaker Pin Header (JFP1)**

Pin	Signal	Pin	Signal
1	+5V	2	HDDLED+
3	Power Button+	4	NC
5	HDDLED-	6	Power Button-
7	SPK_P3	8	SMB_DATA
9	System Reset+	10	SPK_P4
11	SMB_CLK	12	System Reset-

## 1.8.4 Power LED and Keyboard Lock Pin Header (JFP2)

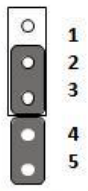
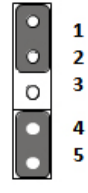


**Table 1.5: Power LED and Keyboard Lock Pin Header (JFP2)**

Pin	Signal
1	LED Power
2	NC
3	GND
4	Keyboard LOCK#
5	GND



## 1.8.5 Watchdog Timer Output and OBS Beep (JWDT1+JOBS1)

**Table 1.6: Watchdog Timer Output and OBS Beep (JWDT1+JOBS1)**

Function	Jumper Setting
Watchdog Timer Output(2-3) (Default) OBS BEEP(4-5) (Default)	 <p>(2 and 3)+(4 and 5)</p>
Watchdog Timer Disable (1-2) OBS BEEP(4-5) (Default)	 <p>(1 and 2)+(4 and 5)</p>

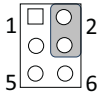
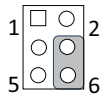
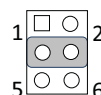
## 1.8.6 ATX/AT Mode Selection (PSON1)

**Table 1.7: ATX/AT Mode Selection (PSON1)**

Function	Jumper Setting
AT Mode	<p>1    2    3</p>  <p>1-2 closed</p>
ATX Mode (Default)	<p>1    2    3</p>  <p>2-3 closed</p>

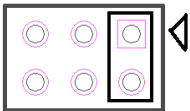
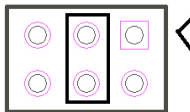
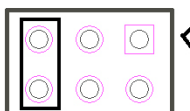
## 1.8.7 LVDS Panel Voltage Selection (JLVDS1)

**Table 1.8: LVDS Panel Voltage Selection (JLVDS1)**

Function	Jumper Setting
Jumper position for 5V	 JLVDS1 (2-4)
Jumper position for 3.3V (Default)	 JLVDS1 (4-6)
Jumper position for 12V	 JLVDS1 (3-4)

## 1.8.8 COM2 RI# Pin RI#/5V/12V Select (JSETCOM2\_V1)

**Table 1.9: COM2 RI# Pin RI#/5V/12V Select (JSETCOM2\_V1)**

Function	Jumper Setting
Jumper position for RI#(Default)	 1 and 2
Jumper position for 5V	 3 and 4
Jumper position for 12V	 5 and 6

## 1.9 System Memory

AIMB-275 has two sockets for a 260 pins DDR4 SO-DIMM. This socket uses a 1.2 V unbuffered double data rate synchronous DRAM (DDR SDRAM). DRAM is available in capacities of 4GB, 8GB and 16GB. The sockets can be filled in any combination with SODIMMs of any size, giving a total memory size between 4GB, 8GB, 16GB, and up to max 32GB. AIMB-275 does NOT support ECC (error checking and correction).

---

## 1.10 Memory Installation Procedures

To install SODIMMs, first make sure the two handles of the SODIMM socket are in the “open” position, i.e., the handles lean outward. Slowly slide the SODIMM module along the plastic guides on both ends of the socket. Then firmly but gently (avoid pushing down too hard) press the SODIMM module well down into the socket, until you hear a click when the two handles have automatically locked the memory module into the correct position of the SODIMM socket. To remove the memory module, just push both handles outward, and the memory module will be ejected by the mechanism.

## 1.11 Cache Memory

The AIMB-275 supports a CPU with one of the following built-in full speed Last Level Cache:

8MB for Intel Core i7-6700 / i7-6700TE

6MB for Intel Core i5-6500 / i5-6500TE

4MB for Intel Core i3-6100 / i3-6100TE

3MB for Pentium G4400 / G4400GE

2MB for Celeron G3900 / G3900GE

The built-in second-level cache in the processor yields much higher performance than conventional external cache memories.

## 1.12 Processor Installation

The AIMB-275 is designed to supported Intel 6th Gen LGA1151, Core i7/Core i5/ Core i3, Pentium, Celeron processor.



# Chapter 2

Connecting  
Peripherals

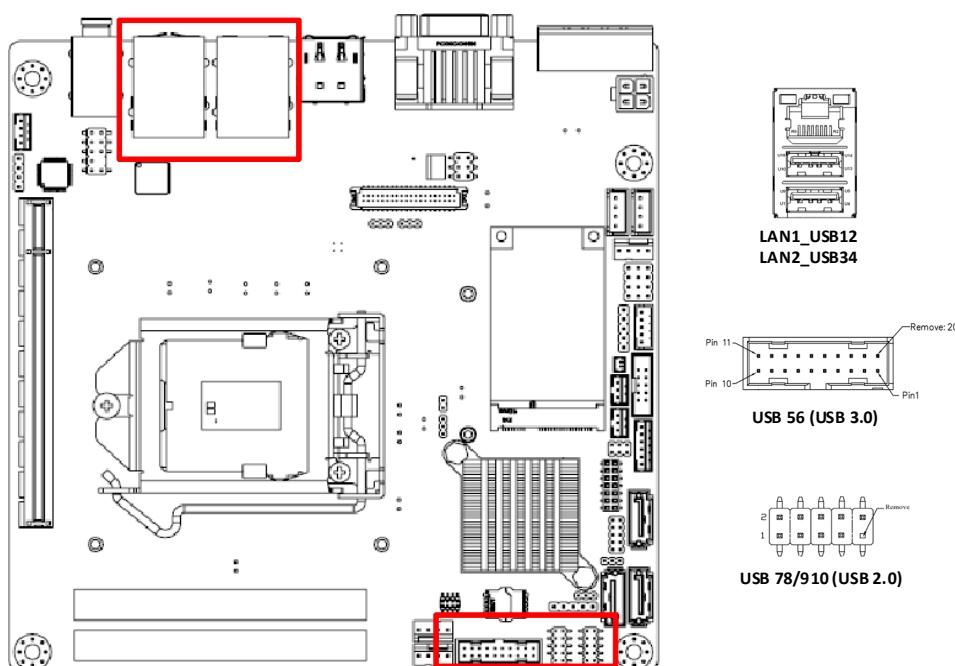
## 2.1 Introduction

You can access most of the connectors from the top of the board as it is being installed in the chassis. If you have a number of cards installed or have a packed chassis, you may need to partially remove the card to make all the connections.

## 2.2 USB Ports (LAN1\_USB12/LAN2\_USB34/USB56/USB78/USB910)

The AIMB-275 provides up to ten USB ports. Four USB3.0 on the rear side and six pin header on the board. The USB interface complies with USB Specification Rev. 2.0 and Rev. 3.0 supporting transmission rates up to 625 Mbps and is fuse protected. The USB interface can be disabled in the system BIOS setup.

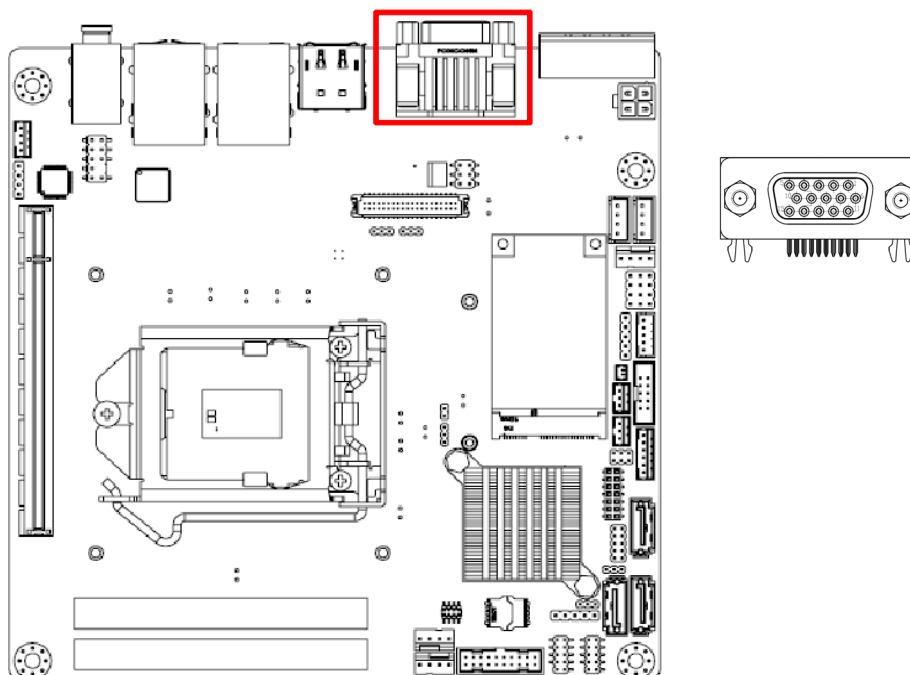
The AIMB-275 is equipped with two high-performance 1000 Mbps Ethernet LAN adapter, which are supported by all major network operating systems. The RJ-45 jacks on the rear panel provides for convenient LAN connection.



**Table 2.1: LAN LED Indicator**

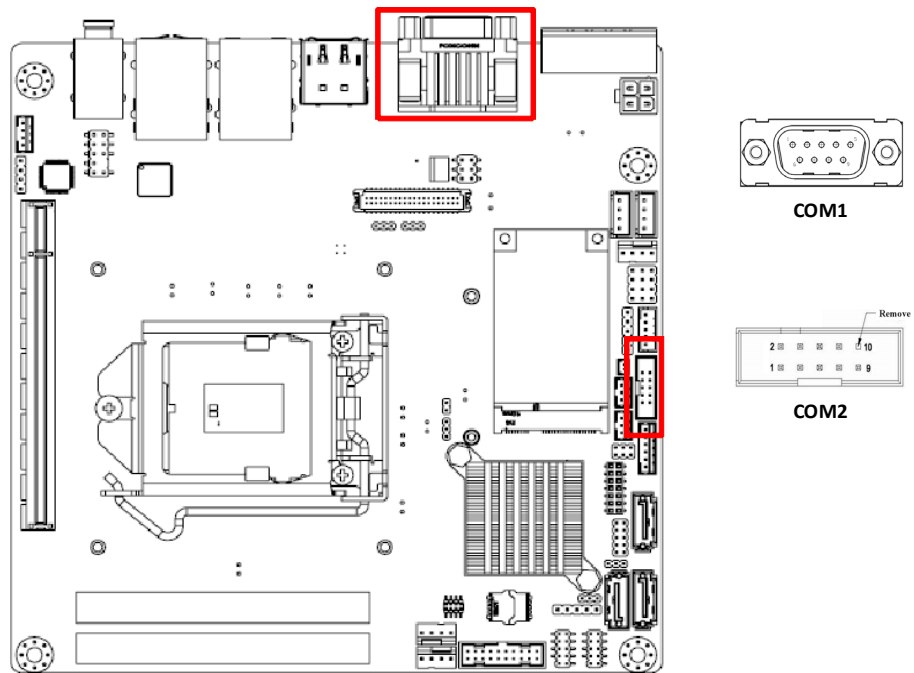
LAN Mode	LAN Indicator	
LAN1 indicator	LED1 (Right)	off for mal-link; Link (On) / Active (Flash)
	LED2 (Left)	100 Mbps (On) / 10 Mbps (Off); Color: Orange (10/100 Mbps)
	LED2 (Left)	1000 Mbps (On); Color: Green (1000 Mbps)
LAN2 indicator	LED1 (Right)	off for mal-link; Link (On) / Active (Flash)
	LED2 (Left)	100 Mbps (On) / 10 Mbps (Off); Color: Orange (10/100 Mbps)
	LED2 (Left)	1000 Mbps (On); Color: Green (1000 Mbps)

## 2.3 VGA Connector(VGA1)



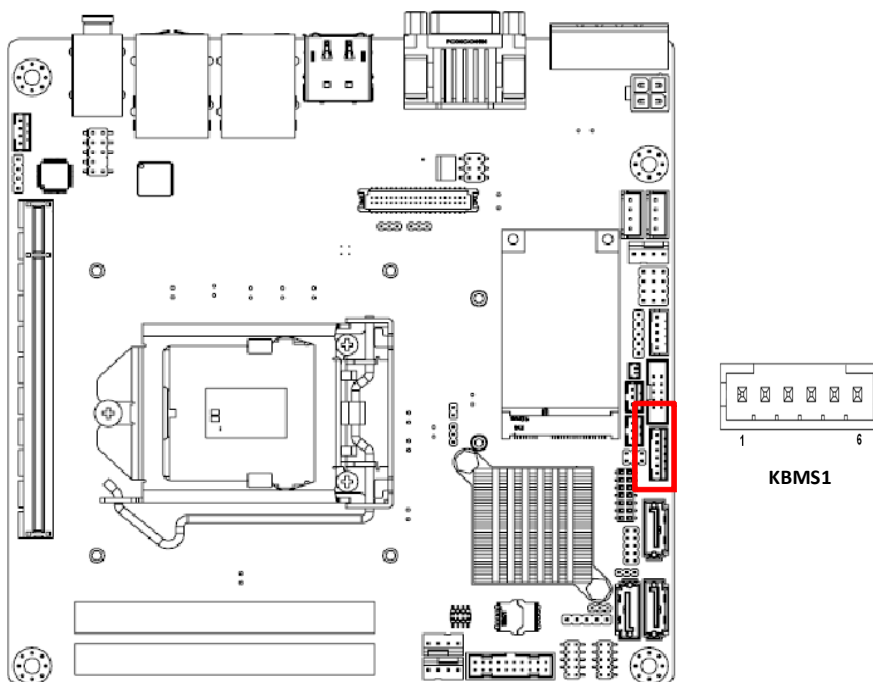
The AIMB-275 includes VGA interface that can drive conventional VGA displays. VGA1 is a standard 15-pin D-SUB connector commonly used for VGA.

## 2.4 Serial Ports (COM1~COM2)



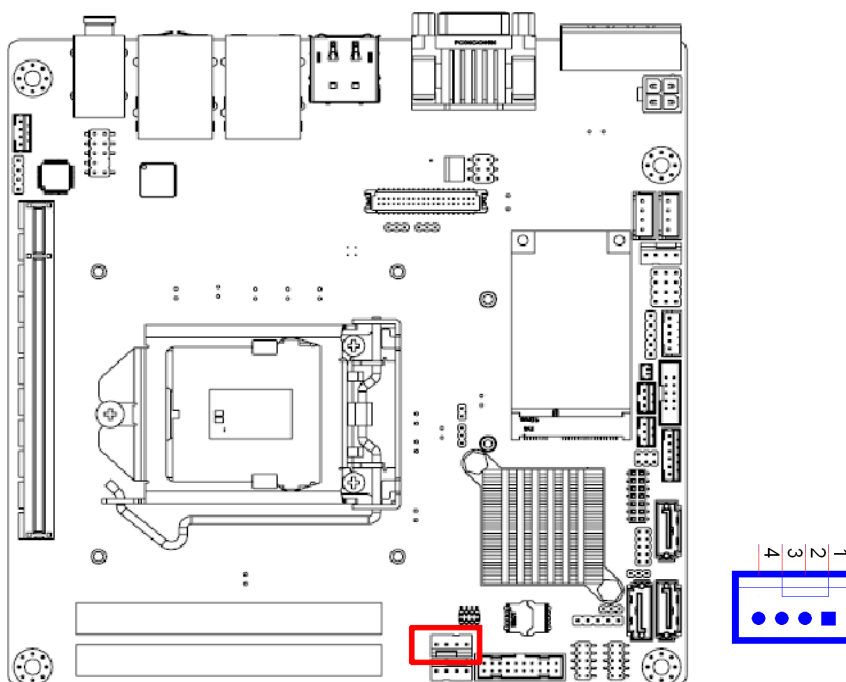
AIMB-275 supports two serial ports, COM1 supports RS-232 function, COM2 supports RS-232/422/485 function by BIOS selection. These ports can connect to serial devices, such as a mouse or a printer, or to a communications network. The IRQ and address ranges for both ports are fixed. However, if you want to disable the port or change these parameters later, you can do this in the system BIOS setup. Different devices implement the RS-232 standards in different ways. If you have problems with a serial device, be sure to check the pin assignments for the connector.

## 2.5 PS/2 Keyboard and Mouse Connector (KBMS1)



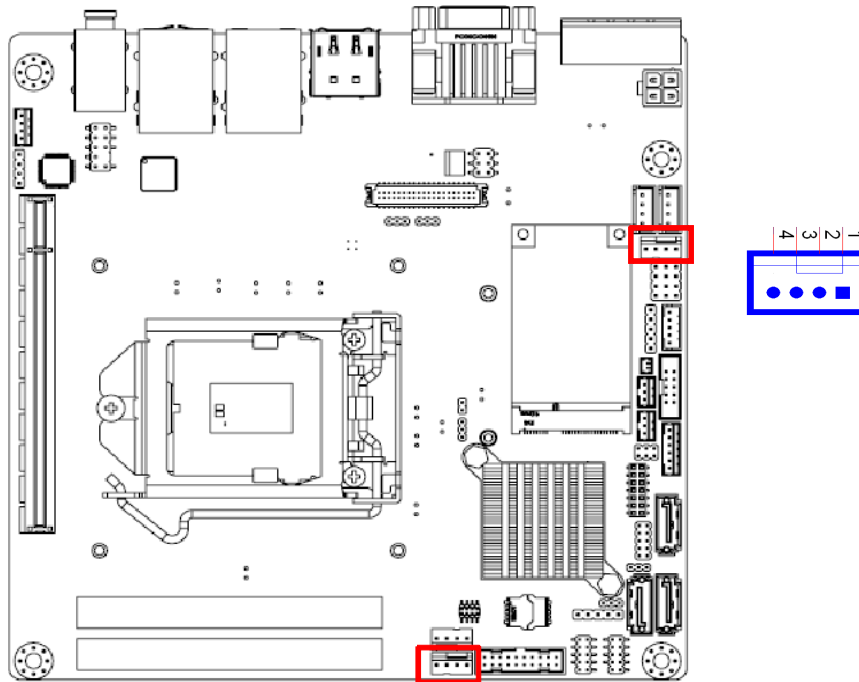
On board 6-pin wafer box connector, supports one standard PS/2 keyboard, one standard PS/2 mouse.

## 2.6 CPU Fan Connector (CPU\_FAN1)



If a fan is used, this connector supports cooling fans of 500 mA (6 W) or less.

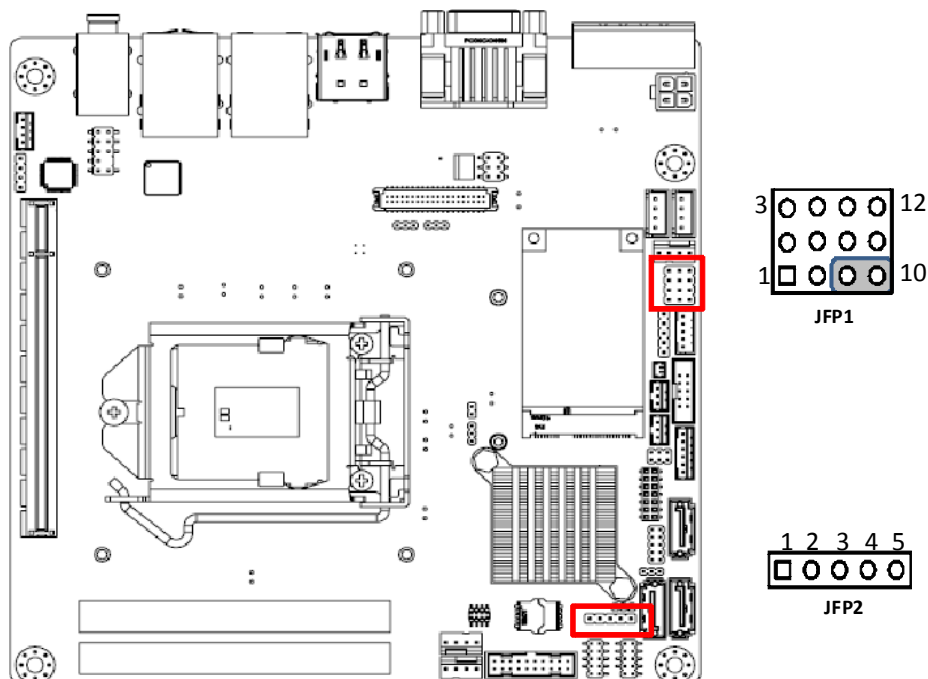
## 2.7 System FAN Connector (SYSFAN1/2)



If a fan is used, this connector supports cooling fans of 500 mA (6 W) or less.

## 2.8 Power Switch/HDD LED/SMBUS/Speaker Pin Header (JFP1) & Power LED and Keyboard Lock Pin Header (JFP2)

There are several headers for monitoring and controlling the AIMB-275.



### 2.8.1 ATX soft power switch (JFP1/PWR\_SW)

If your computer case is equipped with an ATX power supply, you should connect the power on/off button on your computer case to (JFP1/ PWR\_SW), for convenient power on and off.

### 2.8.2 Reset (JFP1/RESET)

Many computer cases offer the convenience of a reset button. Connect the wire for the reset button.

### 2.8.3 HDD LED (JFP1/HDDLED)

You can connect an LED to connector (JFP1/HDDLED) to indicate when the HDD is active.

### 2.8.4 External speaker (JFP1/SPEAKER)

JFP1/SPEAKER is a 4-pin connector for an external speaker. If there is no external speaker, the AIMB-275 provides an onboard buzzer as an alternative. To enable the buzzer, set pins 7 & 10 as closed.

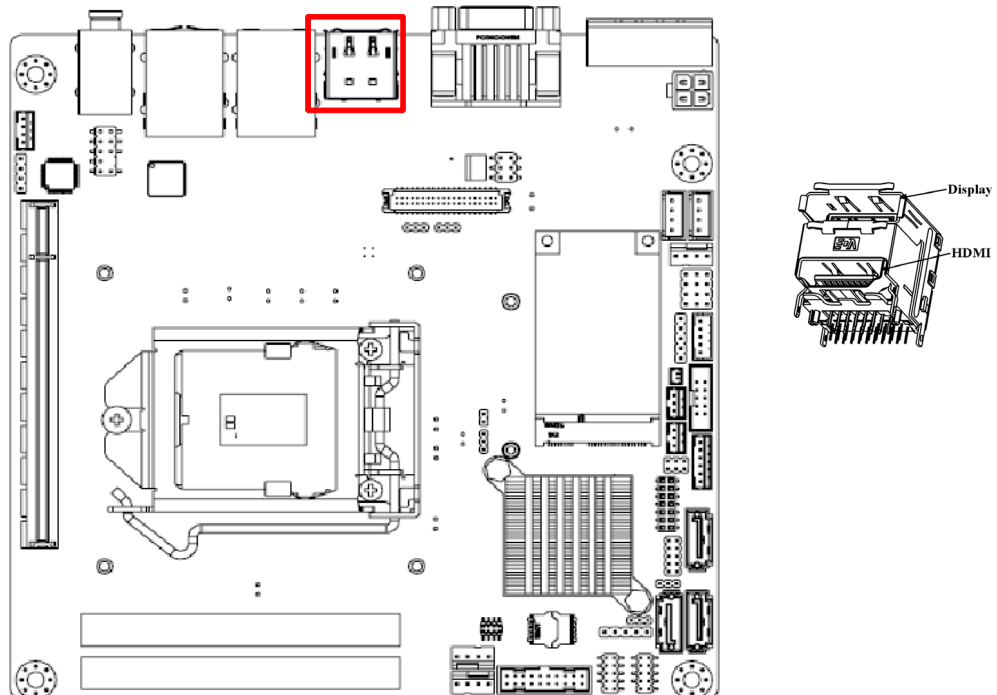
## 2.8.5 Power LED and keyboard lock connector (JFP2/PWR\_LED & KEY LOCK)

(JFP2/PWR\_LED & KEY LOCK) is a 5-pin connector for the power on LED and Key Lock function. Refer to Appendix B for detailed information on the pin assignments. The Power LED cable should be connected to pin 1-3. The key lock button cable should be connected to pin 4-5. There are 3 modes for the power supply connection. The first is “ATX power mode”; the system turns on/off by a momentary power button. The second is “AT Power Mode”; the system turns on/off via the power supply switch. The third is another “AT Power Mode” which makes use of the front panel power switch. The power LED status is indicated in the following table:

**Table 2.2: ATX power supply LED status (No support for AT power)**

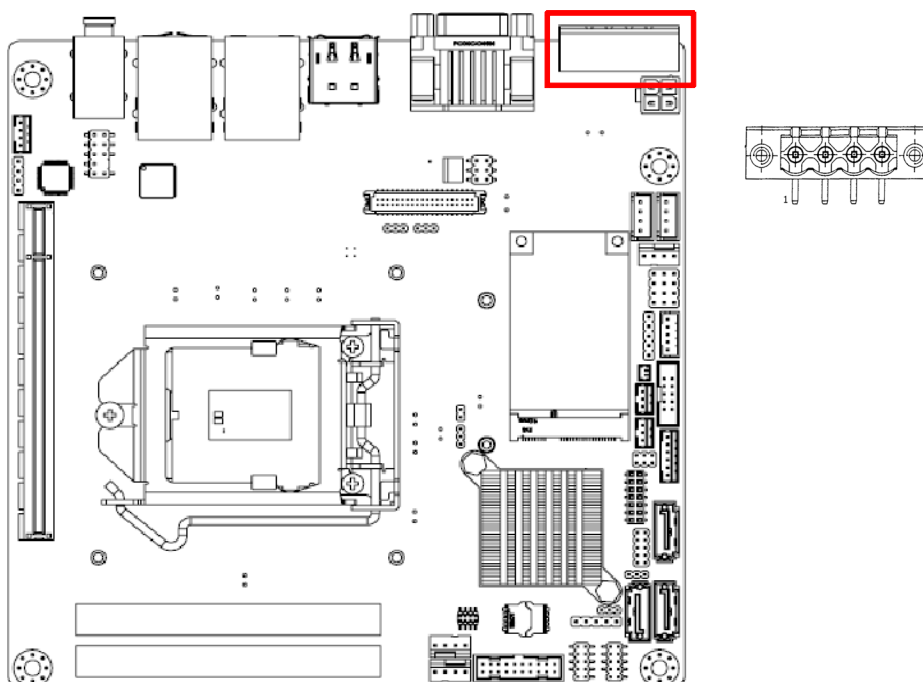
Power mode	LED (ATX Power Mode) (On/off by momentary button)	LED (AT power Mode) (On/off by switching power supply)	LED (AT power Mode) (On/off by front panel switch)
PSON1 (on back plane) jumper setting	pins 2-3 closed	pins 1-2 closed	Connect pins 1 & 2 to panel switch via cable
System On	On	On	On
System Off	Off ( Windows 7) Slow Flashes (Window 8)	Off	Off
System Suspend (S3)	Fast Flashes	NA	NA
System Suspend (S4)	Slow Flashes	NA	NA

## 2.9 Display Port and HDMI Common Connector (DP-HDMI1)

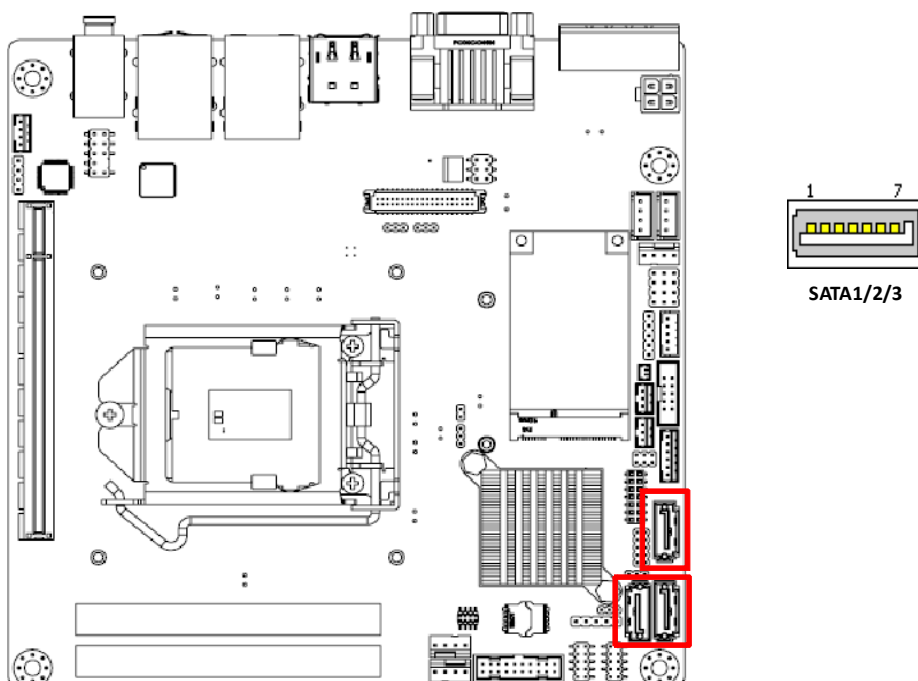




## 2.10 DC Input Phoenix Connector (DCIN1)

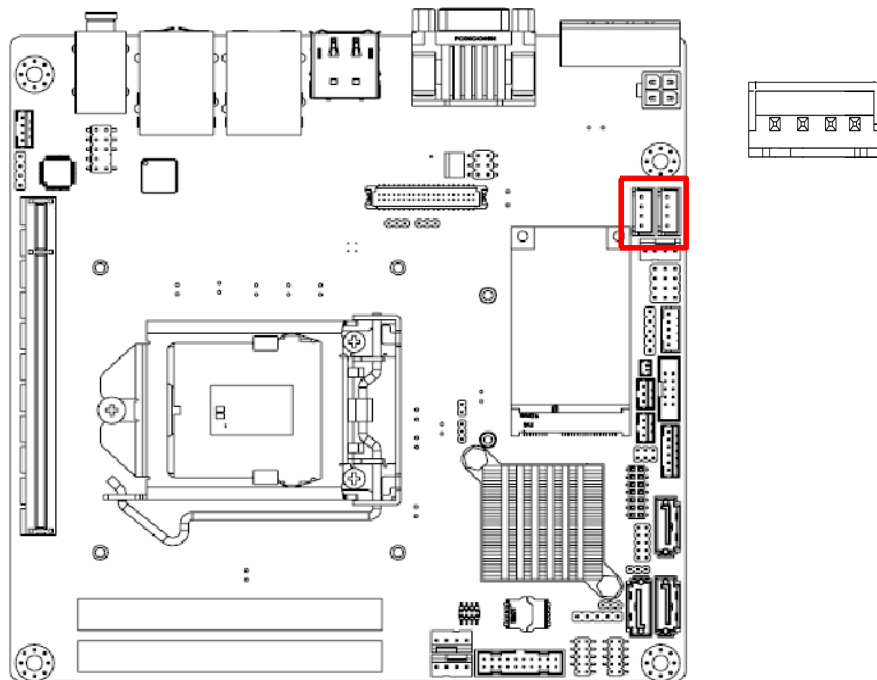


## 2.11 SATA Signal Connector (SATA1 ~ SATA3)



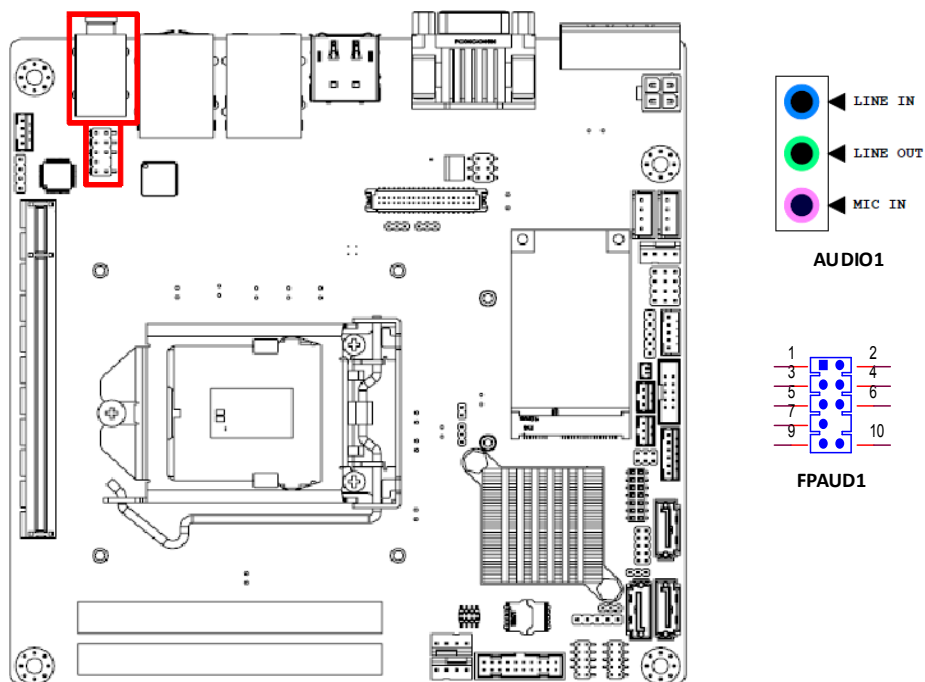
AIMB-275 features a high performance Serial ATA III interface (up to 600 MB/s) which eases hard drive cabling with thin, space-saving cables.

## 2.12 SATA\_PWR1/2



## 2.13 HD Analog Audio Interface (AUDIO1, FPAUD1)

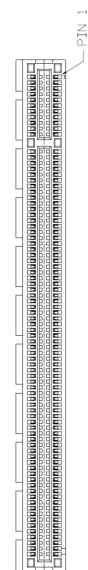
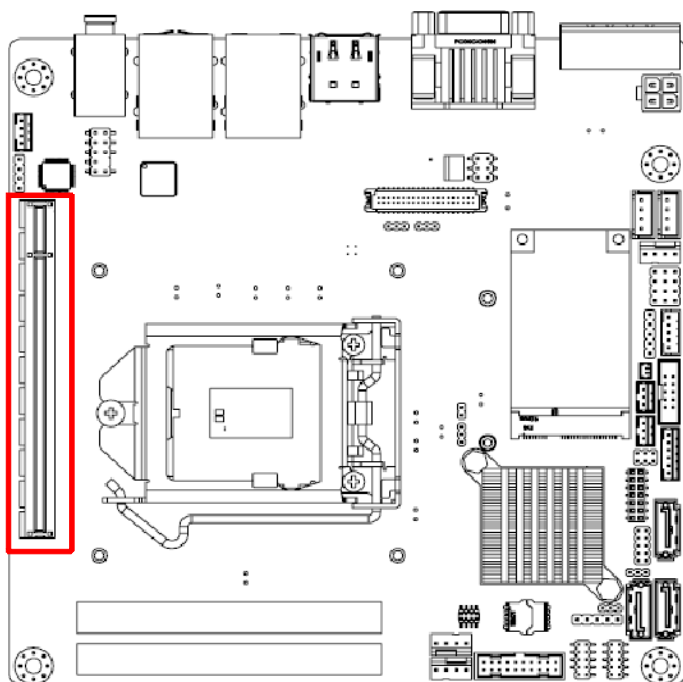
Front headphone connector (FPAUD1) is for a chassis-mounted front panel audio I/O module that supports either HD Audio or legacy AC'97 (optional) audio standard. Connect this connector with the front panel audio I/O module cable.



**Note!** *For motherboards with the optional HD Audio feature, we recommend that you connect a high-definition front panel audio module to this connector to take advantage of the motherboard's high definition audio capability.*

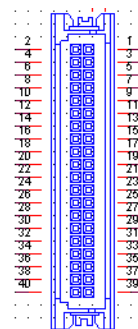
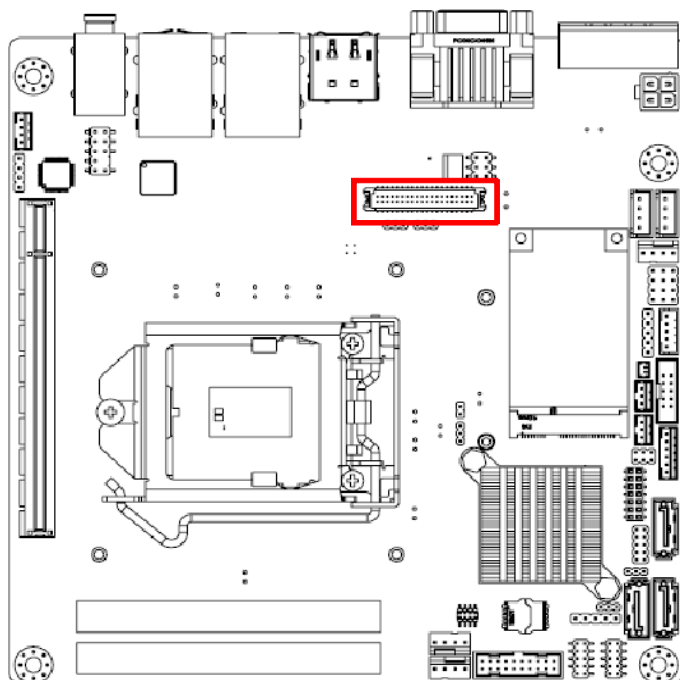


## 2.14 PCI-E x16 Slot (PCIEX16\_1)

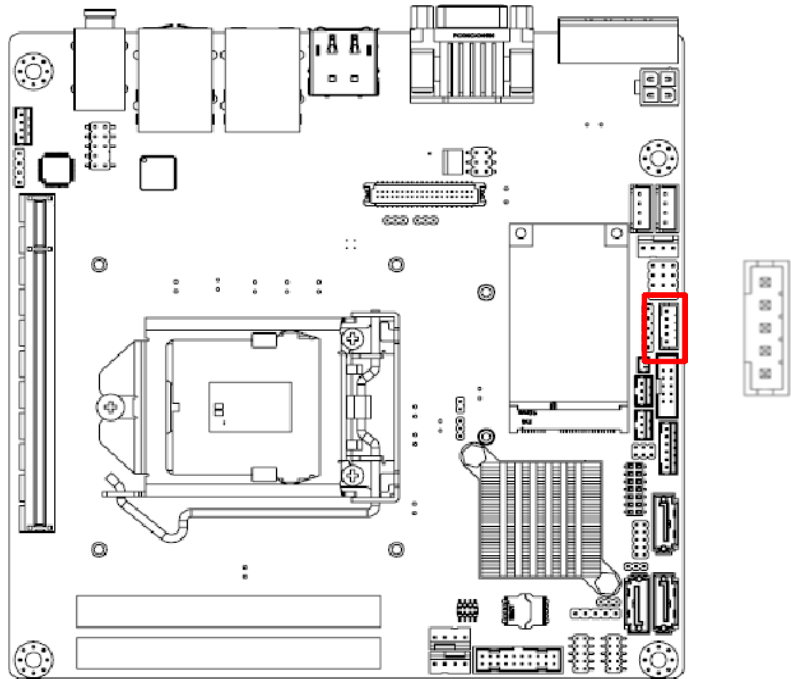


AIMB-275 provides 1 x PCI express x16 slot.

## 2.15 LVDS Panel Connector (LVDS1)



## 2.16 LVDS Backlight Inverter Power Connector (INV1)



**Note!** ■ **Signal Description**



**Signal**

VR

ENBKL

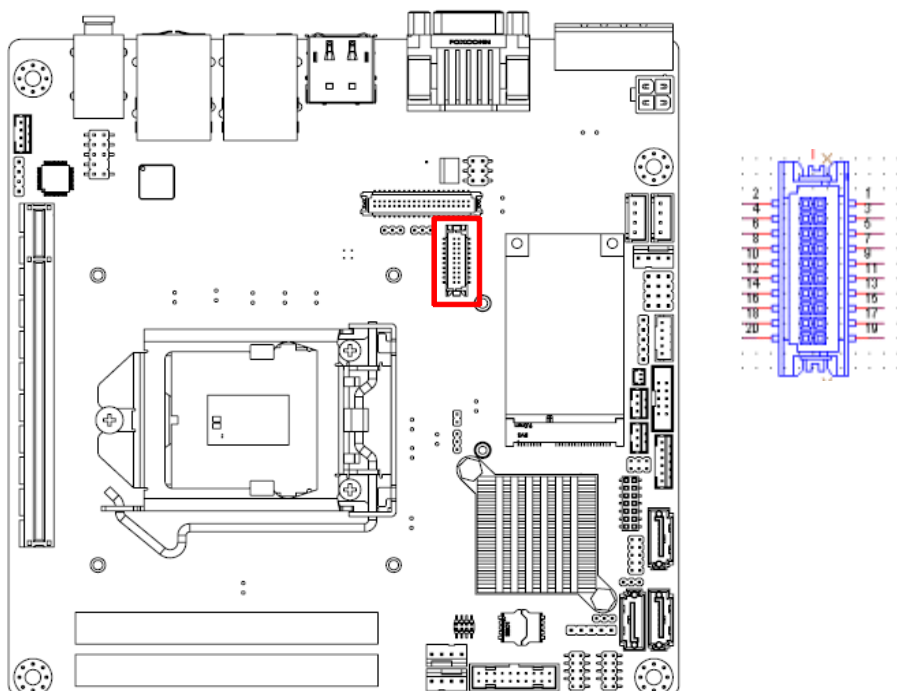
**Signal Description**

$V_{adj}=0.75\text{ V}$

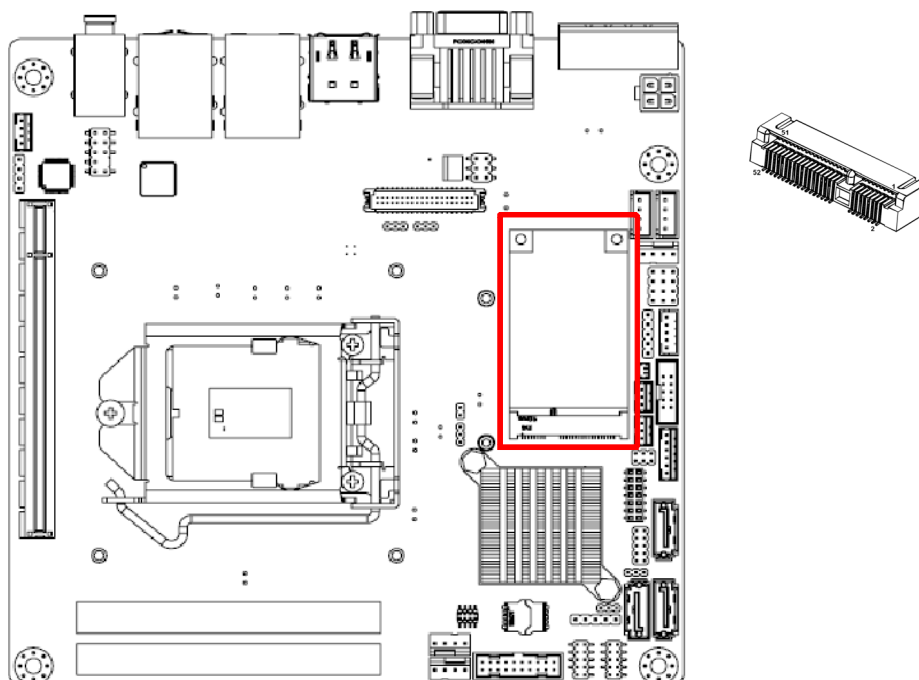
(Recommended:  $4.7\text{ K}\Omega$ ,  $>1/16\text{ W}$ )

LCD backlight ON/OFF control signal

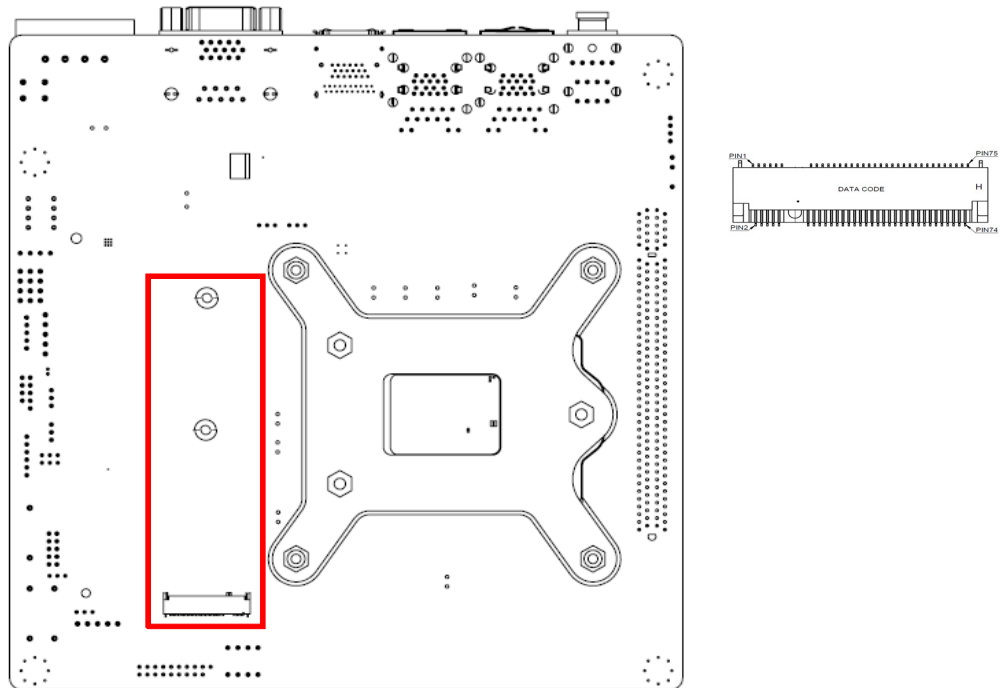
## 2.17 Embedded Display Port Connector (EDP1), BOM optional



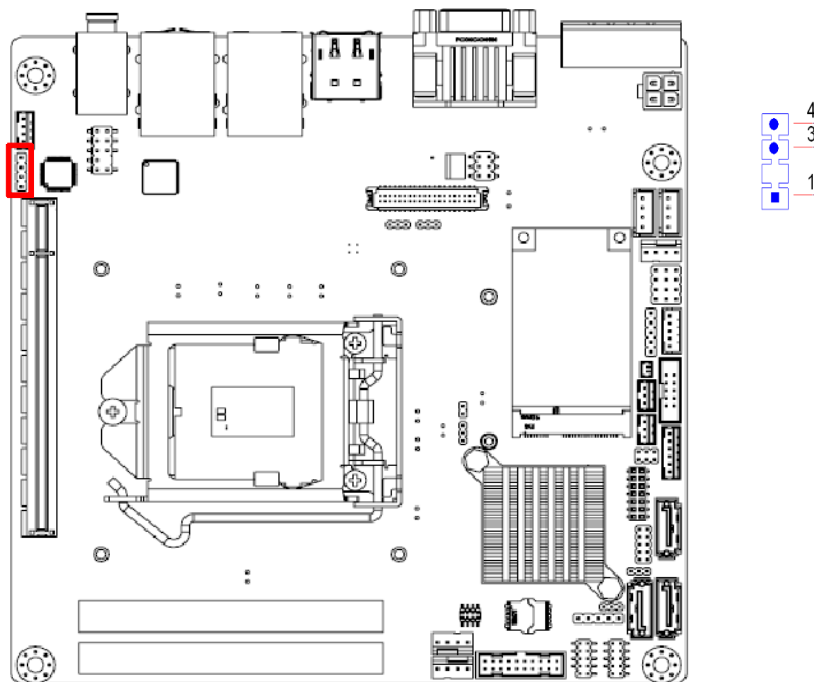
## 2.18 MINIPCIE and mSATA Connector (MINIPCIE1)



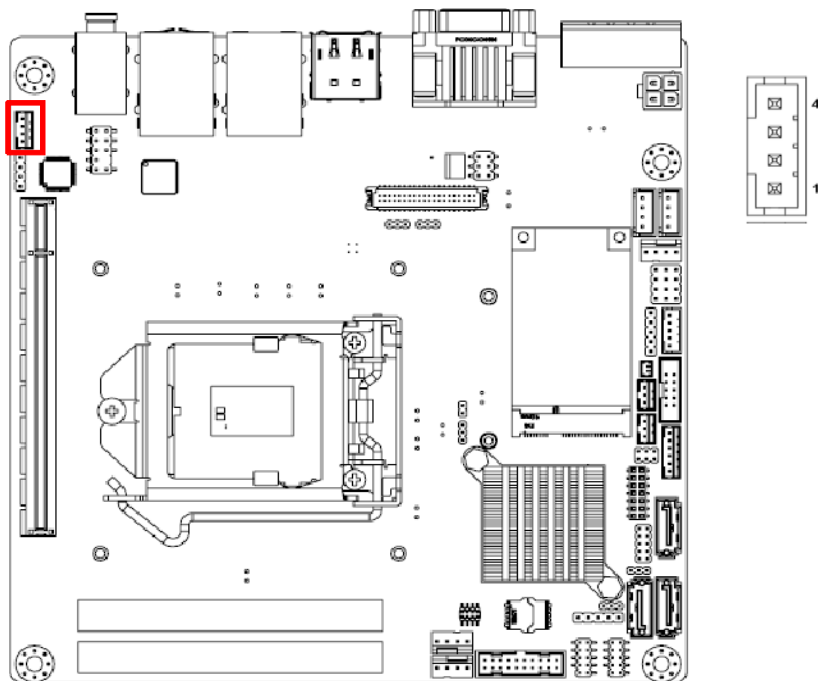
## 2.19 Front Next Generation Form Factor (M.2\_1)



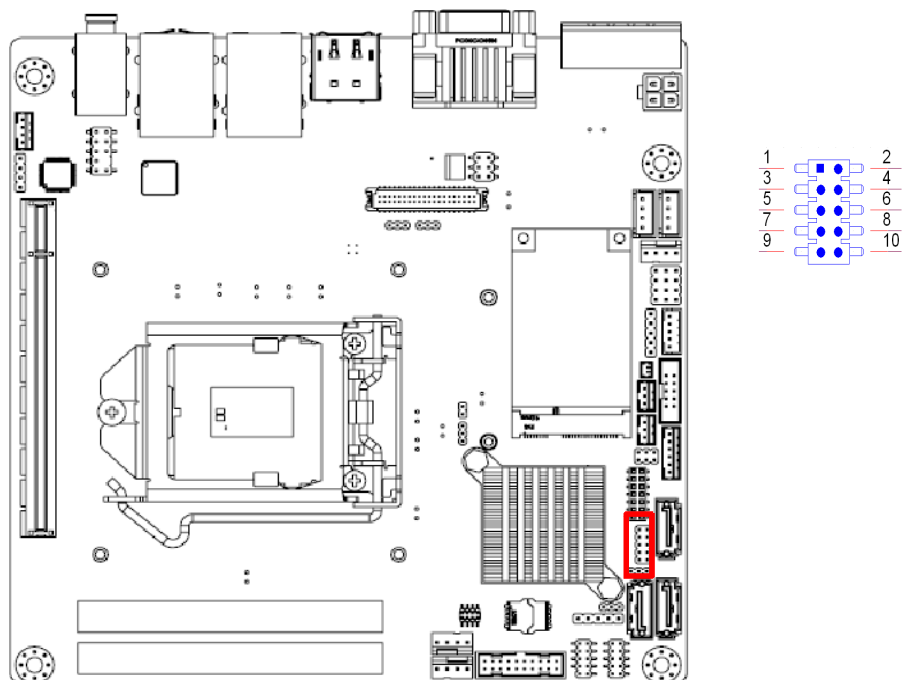
## 2.20 HD Digital Audio Interface (SPDIF1)



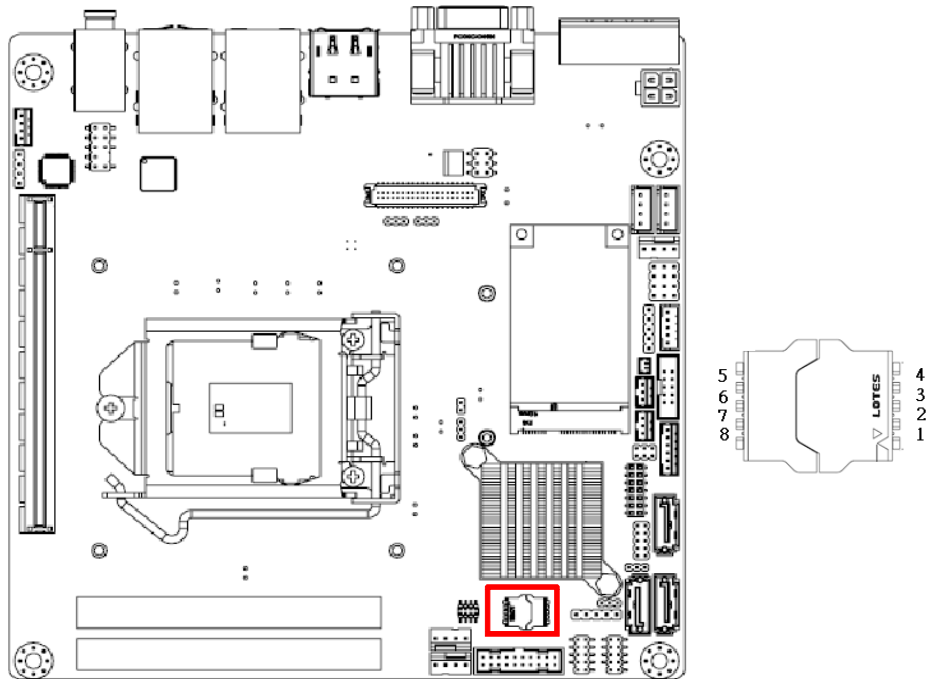
## 2.21 Audio Amplifier Output Connector (AMP1), BOM optional



## 2.22 General Purpose I/O Pin Header (GPIO1)

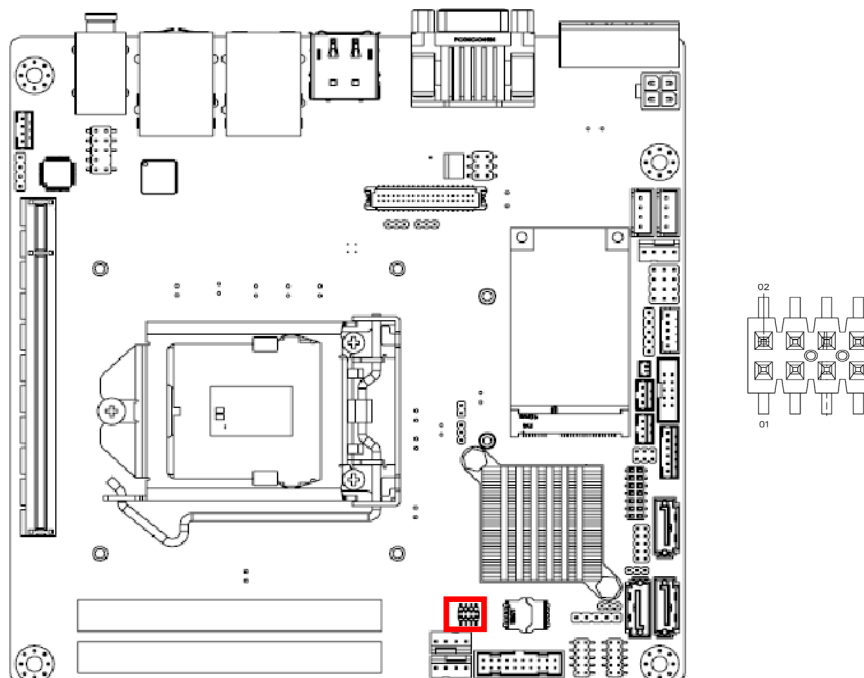


## 2.23 SPI BIOS Flash Socket (SPI1)



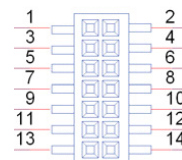
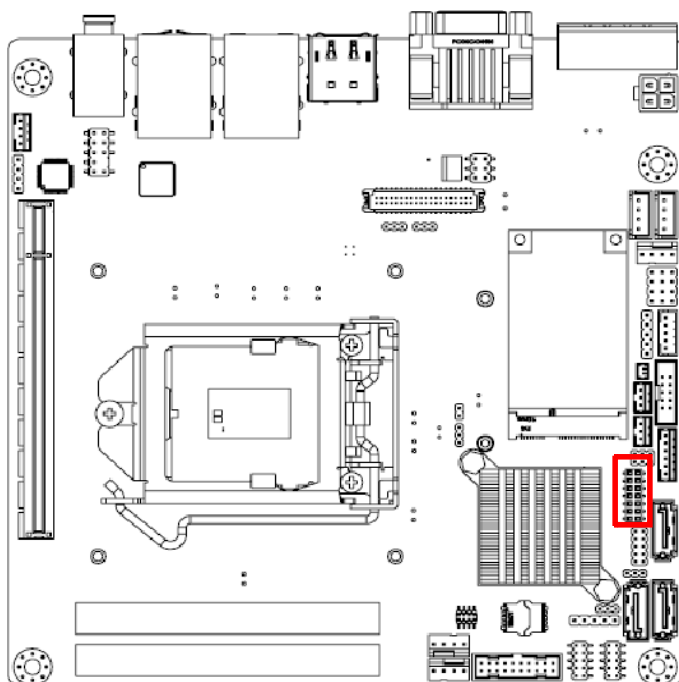
## 2.24 SPI Programming Pin Header (SPI\_CN1)

The SPI flash card pin header may be used to flash BIOS if the AIMB-275 cannot power on.

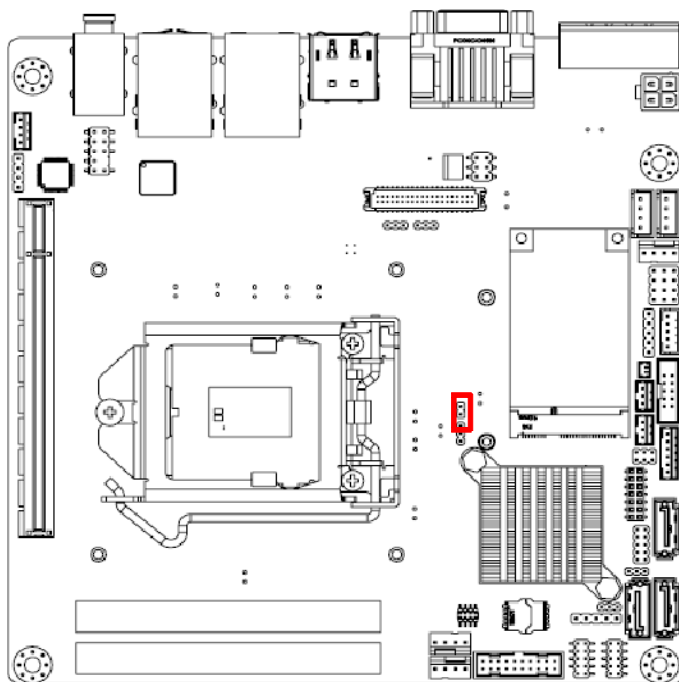




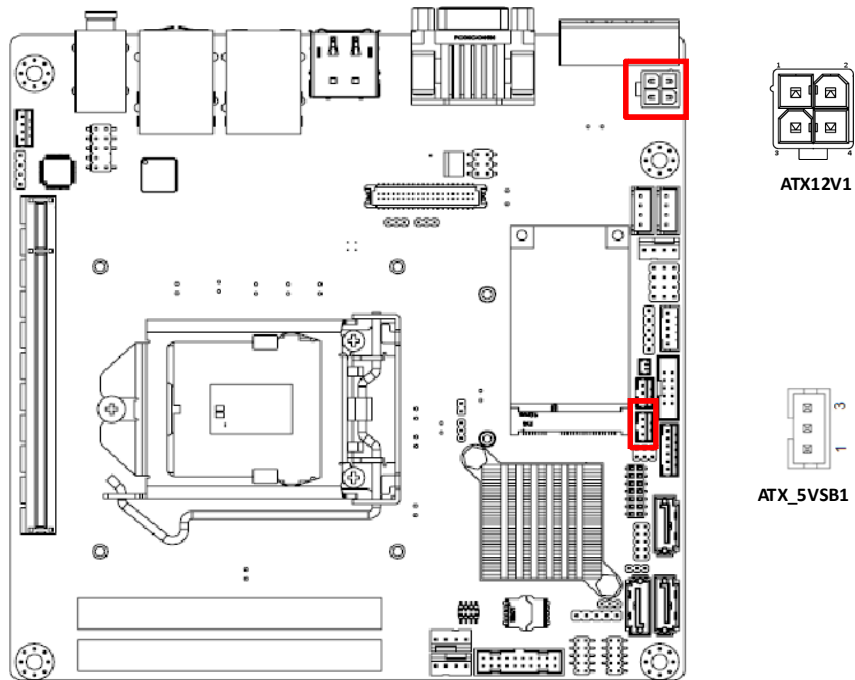
## 2.25 Low Pin Count Header (LPC1)



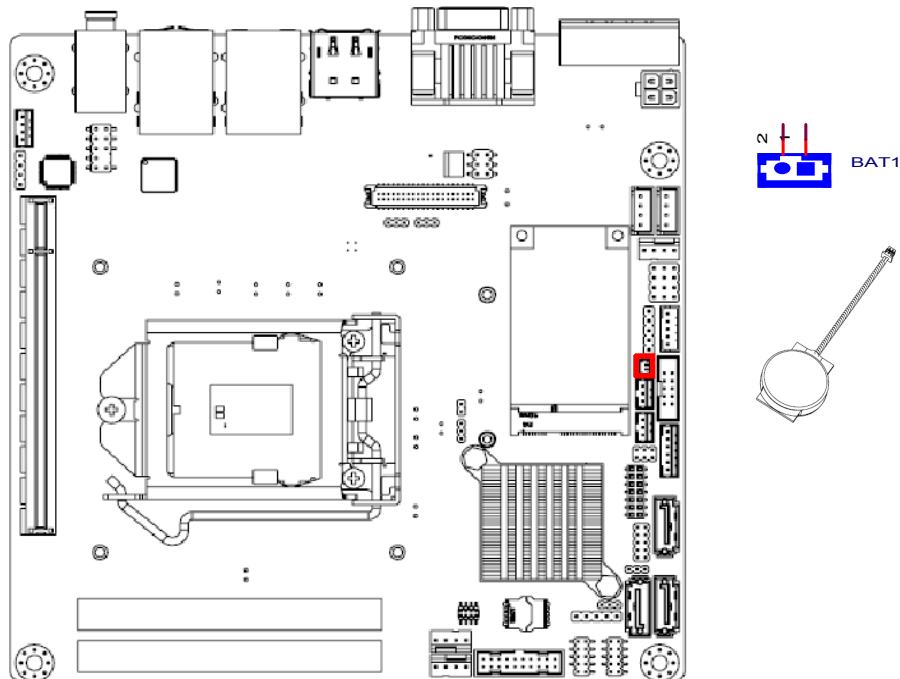
## 2.26 Case-Open Detect Connector (JCASE1)



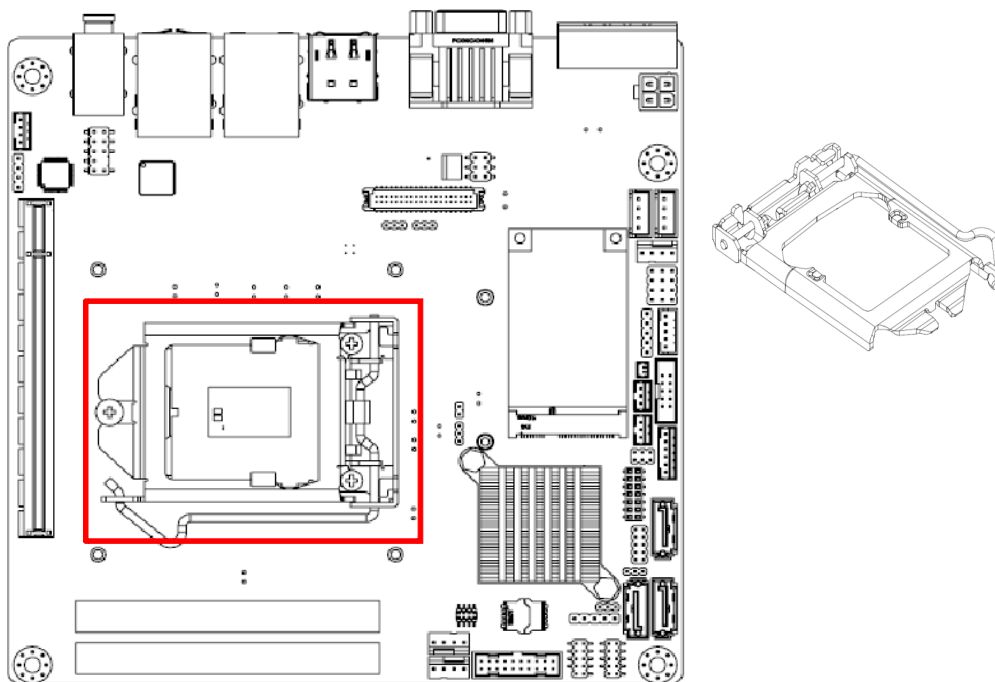
## 2.27 ATX 12V Power Supply Connector (ATX12V1) & ATX Power Supply Connector (ATXPWR1)



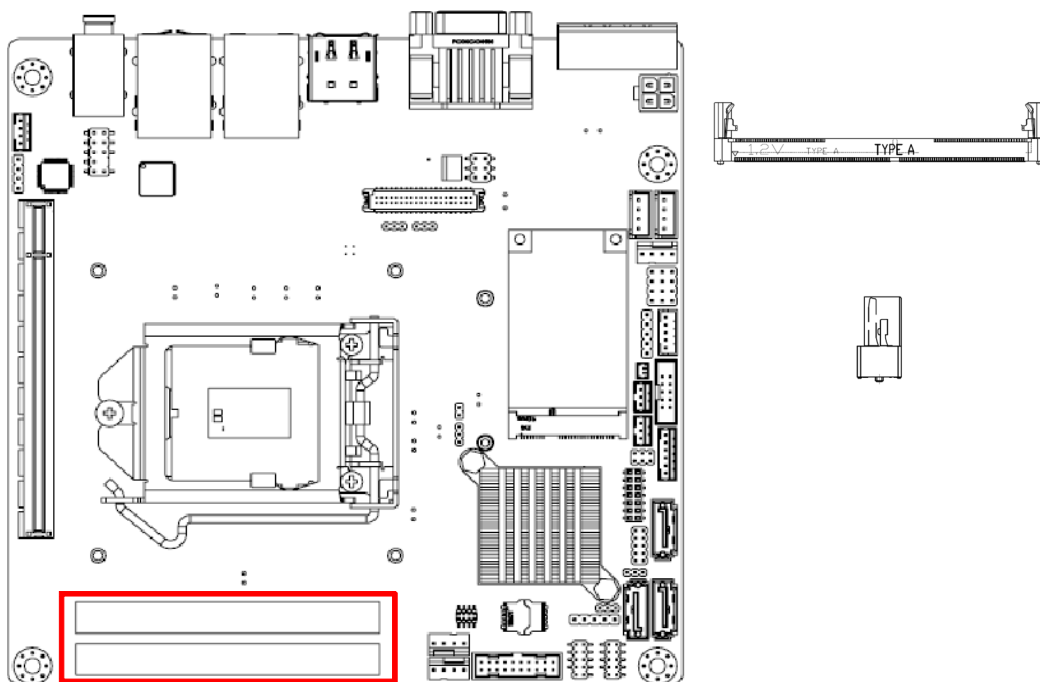
## 2.28 Battery Holder (BAT1)



## 2.29 CPU Socket (CPU1)



## 2.30 DDR4 SO-DIMM Socket (DIMMA1, DIMMB1)





# Chapter 3

BIOS Operation

## 3.1 Introduction

With the AMI BIOS Setup program, you can modify BIOS settings and control the special features of your computer. The Setup program uses a number of menus for making changes and turning special features on or off. This chapter describes the basic navigation of the AIMB-275 setup screens.

## 3.2 BIOS Setup

The AIMB-275 Series system has AMI BIOS built in, with a CMOS SETUP utility that allows users to configure required settings or to activate certain system features. The CMOS SETUP saves the configuration in the CMOS RAM of the motherboard. When the power is turned off, the battery on the board supplies the necessary power to preserve the CMOS RAM. When the power is turned on, press the <Del> button during the BIOS POST (Power-On Self Test) to access the CMOS SETUP screen.

### Control Keys

< ↑ >< ↓ >< ← >< → >	Move to select item
<Enter>	Select Item
<Esc>	Exit
<Page Up/+>	Increase the numeric value or make changes
<Page Down/->	Decrease the numeric value or make changes
<F1>	General help
<F2>	Previous Values
<F3>	Optimized Defaults
<F4>	Save & Exit

### 3.2.1 Main Menu

Press <Del> to enter AMI BIOS CMOS Setup Utility, the Main Menu will appear on the screen. Use arrow keys to select among the items and press <Enter> to accept or enter the sub-menu.



The Main BIOS setup screen has two main frames. The left frame displays all the options that can be configured. Grayed-out options cannot be configured; options in blue can. The right frame displays the key legend.

Above the key legend is an area reserved for a text message. When an option is selected in the left frame, it is highlighted in white. Often a text message will accompany it.

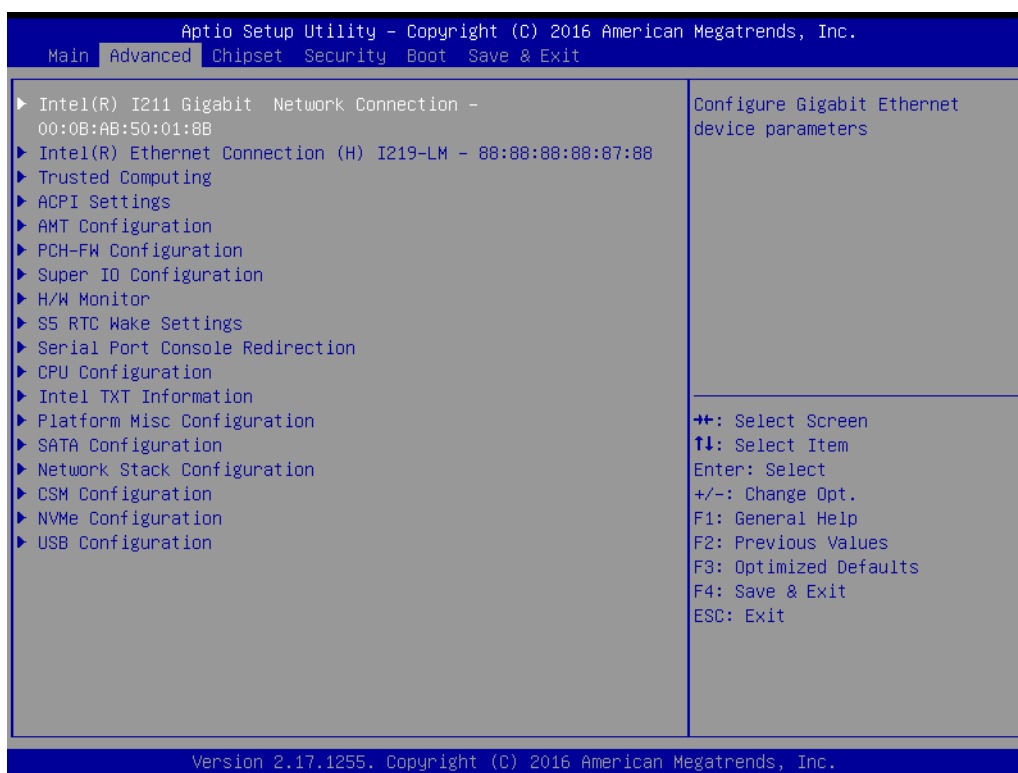
#### ■ System time / System date

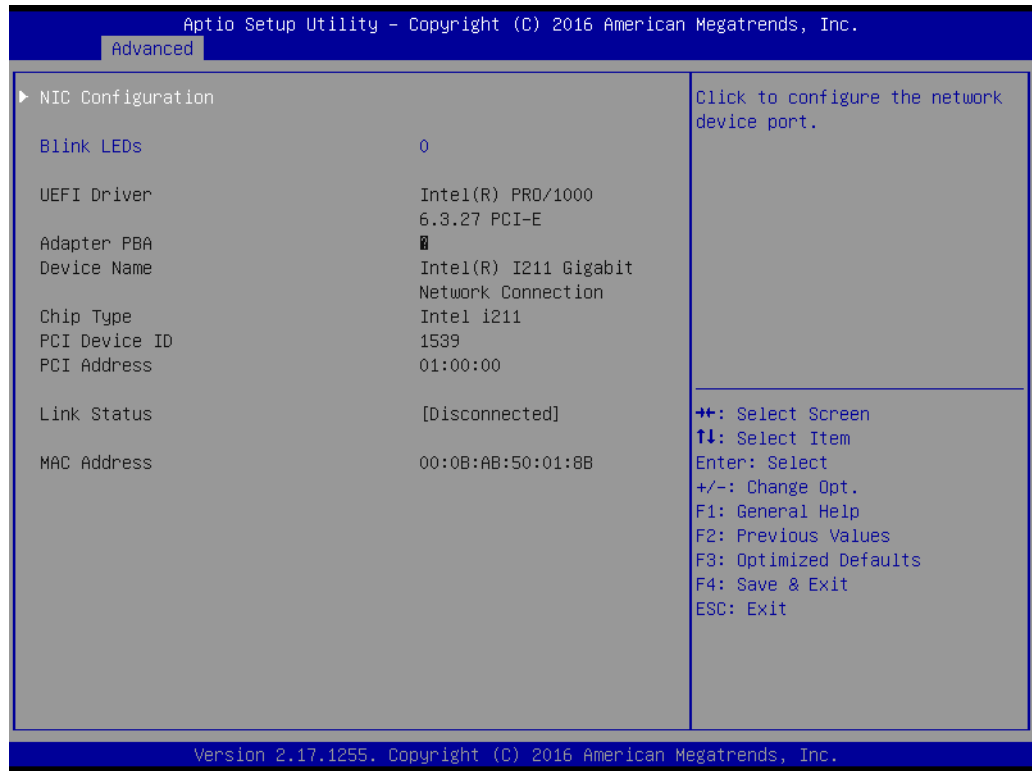
Use this option to change the system time and date. Highlight System Time or System Date using the <Arrow> keys. Enter new values through the keyboard. Press the <Tab> key or the <Arrow> keys to move between fields. The date must be entered in MM/DD/YY format. The time must be entered in HH:MM:SS format.

## 3.2.2 Advanced BIOS Features

Select the Advanced tab from the AIMB-275 setup screen to enter the Advanced BIOS Setup screen. You can select any of the items in the left frame of the screen, such as CPU Configuration, to go to the sub menu for that item. You can display an Advanced BIOS Setup option by highlighting it using the <Arrow> keys. All Advanced BIOS Setup options are described in this section. The Advanced BIOS Setup screen is shown below. The sub menus are described on the following pages.

### 3.2.2.1 Intel® I211 Gigabit Network Connection





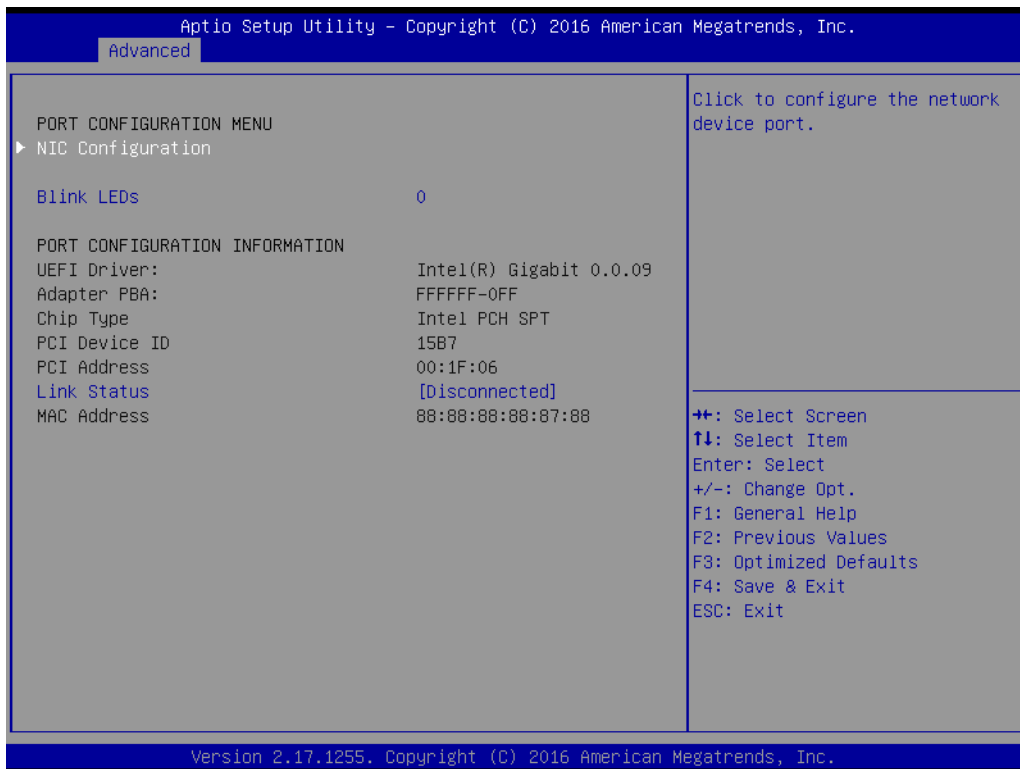
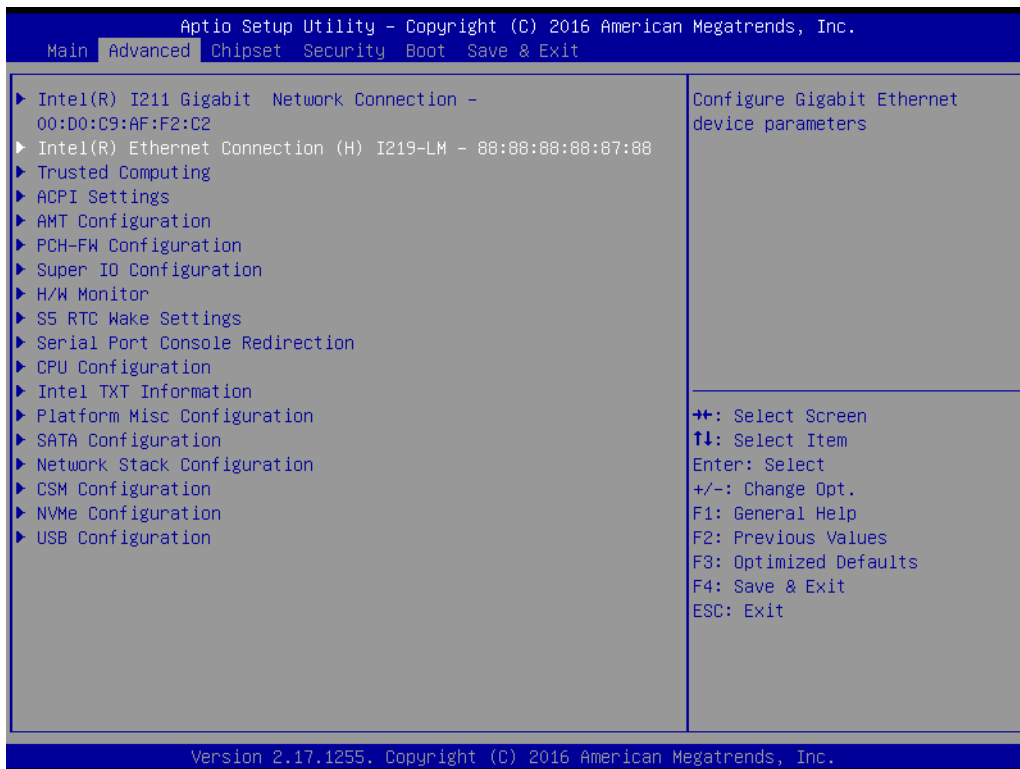
## NIC Configuration



- **Link Speed [ Auto Negotiated ]**  
The value specifies the port speed used for the selected boot protocol.
- **Wake on LAN [Enable]**  
Enables or Disables Wake on LAN (i211) function.



## 3.2.2.2 Intel® Ethernet Connection (H) I219-LM



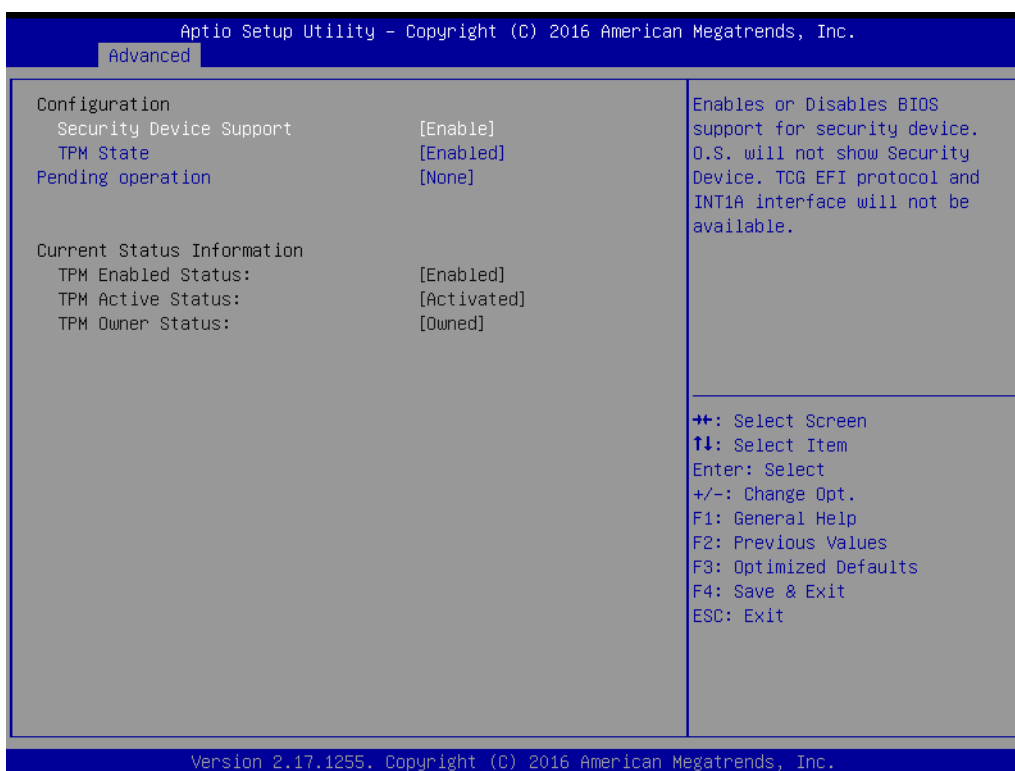
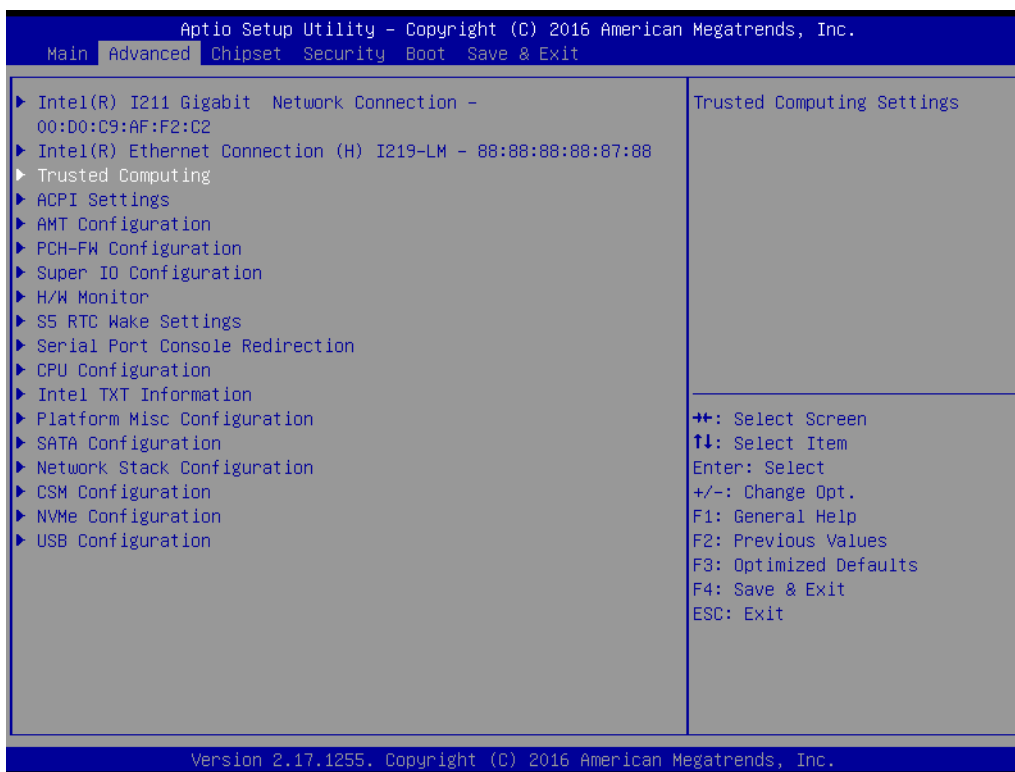
## NIC Configuration



- **Link Speed [ Auto Negotiated ]**  
The value specifies the port speed used for the selected boot protocol.
- **Wake on LAN [N/A]**

### 3.2.2.3 Trusted Computing

To enable/disable TPM (TPM 1.2) set up in BIOS. TPM (Trusted Platform Module) is a secure key generator and key cache management component, enables protected storage of encryption keys and authentication credentials for enhanced security capabilities.



- **Security Device Support [ Enabled ]**  
Enable or Disable BIOS support for security device.

**Note!** TCG EFI Protocol and INT1A interface will not be available.

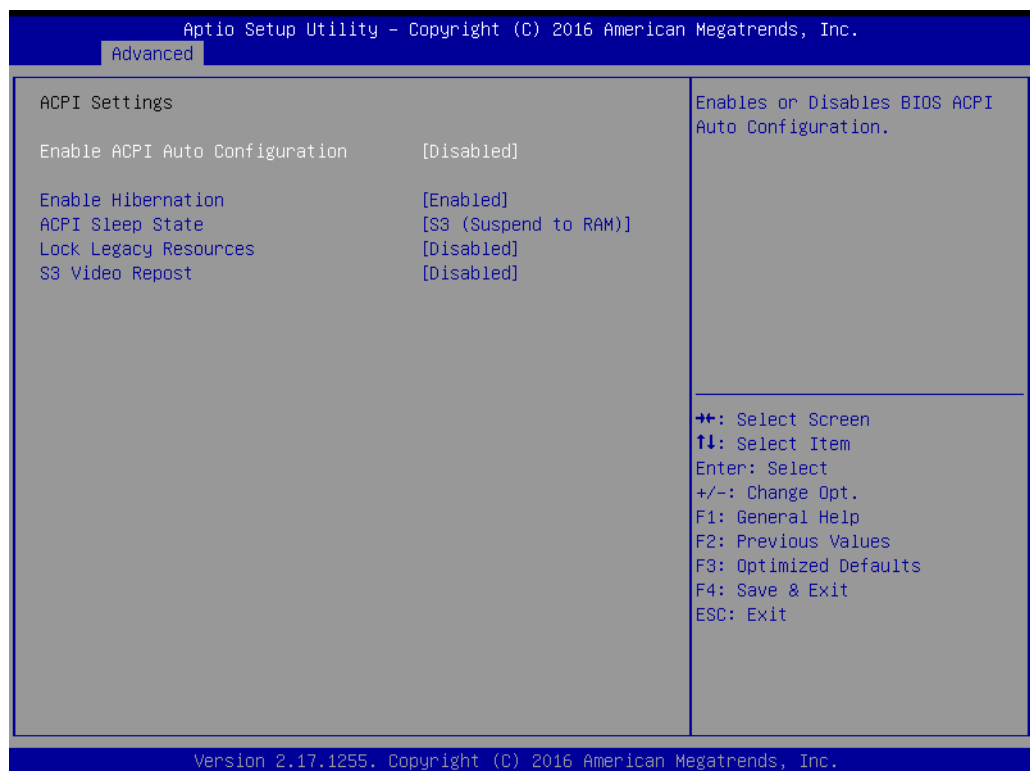
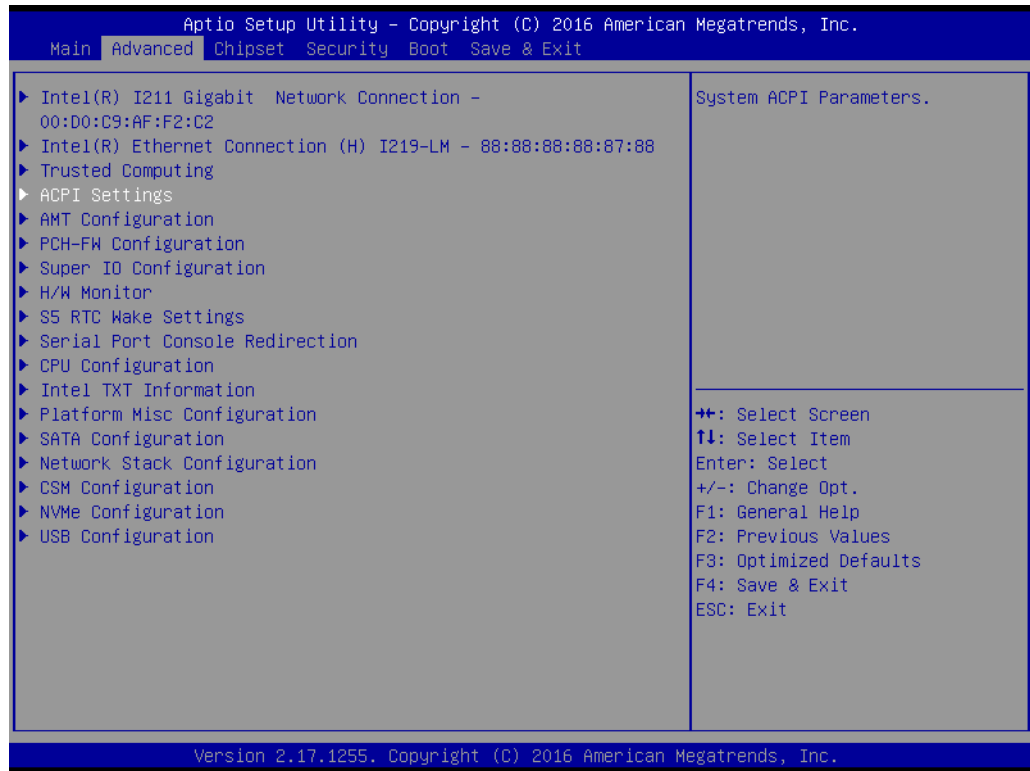


■ **TPM Enabled State [ Enabled ]**

**Note!** *TPM function requests Hardware design supported and BIOS enabled in parallel.*

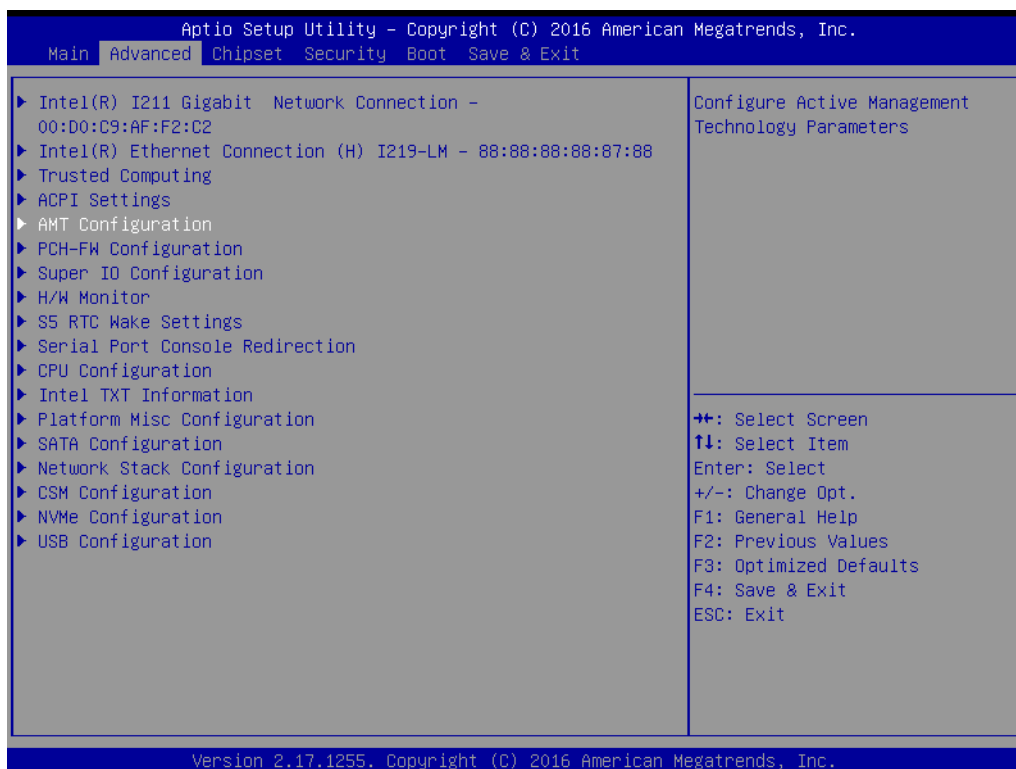


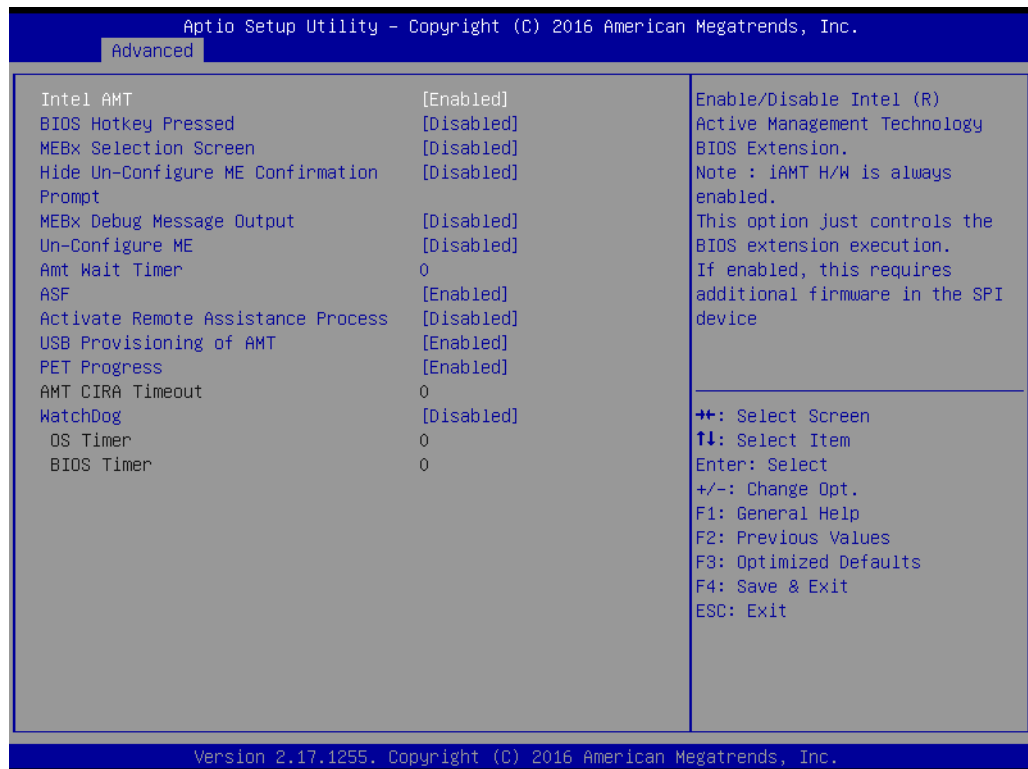
**3.2.2.4 ACPI Settings**



- **Enable ACPI Auto Configuration [ Disabled ]**
- **Enable Hibernation [ Enabled ]**  
Enables or Disables System ability to Hibernate (OS/S4 Sleep State). This option may be not effective with some OS.
- **ACPI Sleep State [ S3 (Suspend to RAM) ]**  
Select ACPI sleep state the system will enter when the SUSPEND button is pressed.
- **Lock Legacy Resources [ Disabled ]**  
S3 Video Repost [ Disabled ]

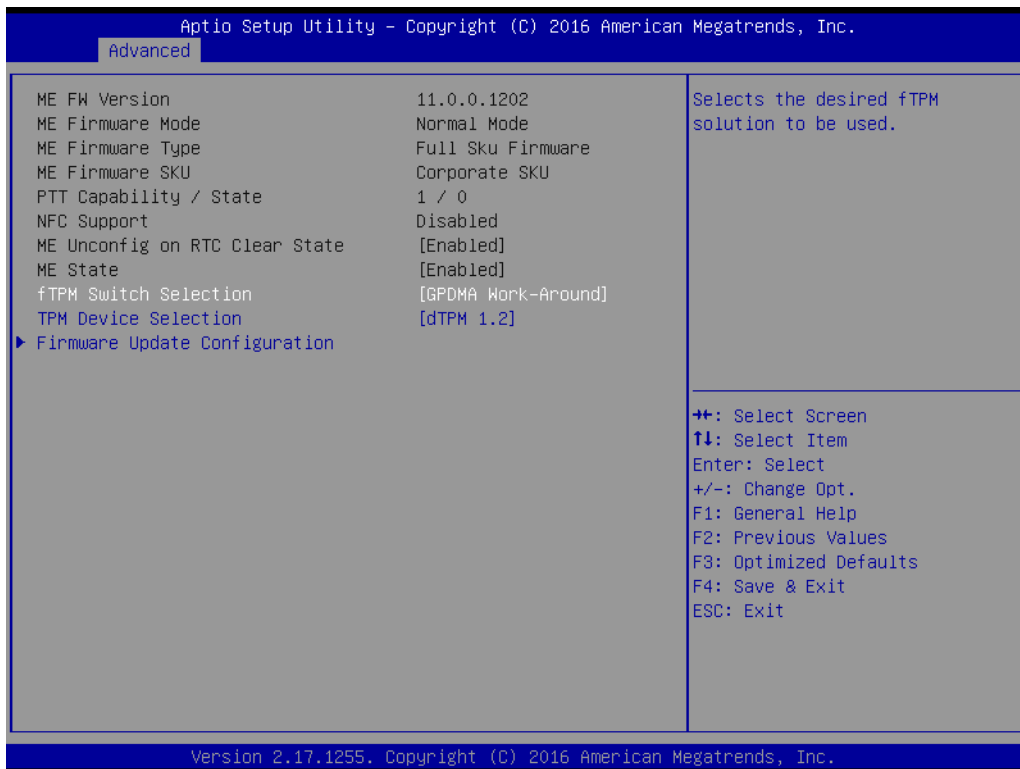
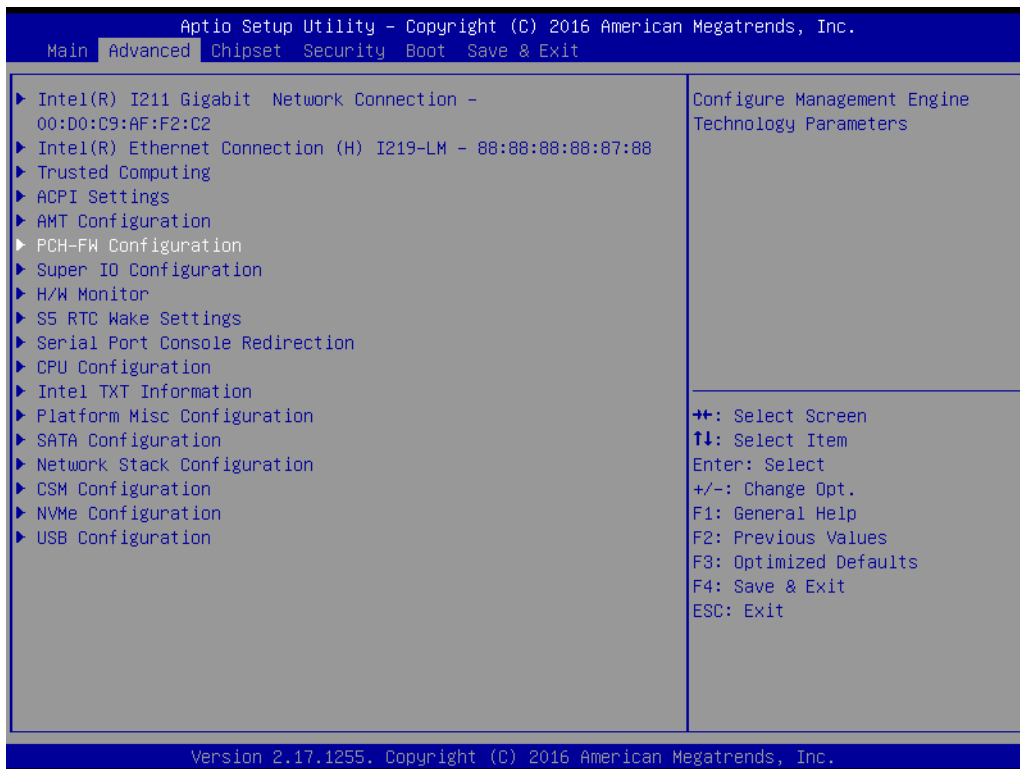
### 3.2.2.5 AMT Configuration





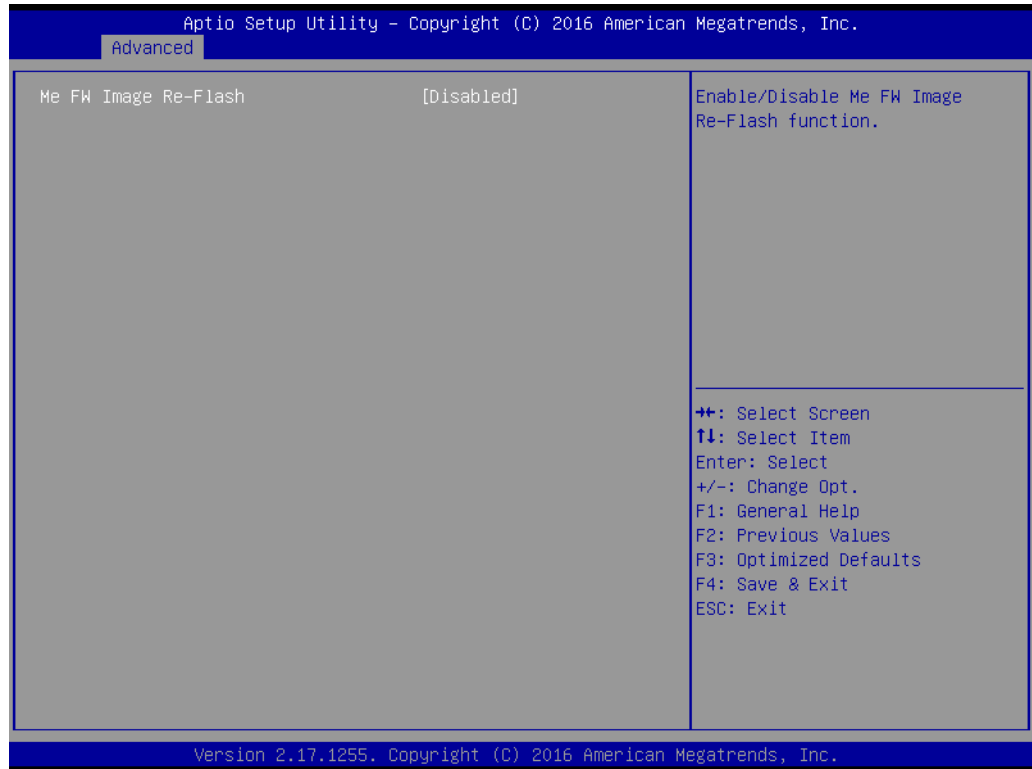
- **Intel AMT [ Enabled ]**  
This item allows users to enable or disable Intel AMT BIOS extension.
- **BIOS Hotkey Pressed [ Disabled ]**
- **MEBx Select Screen [ Disabled ]**
- **Hide Un-Configure ME Confirmation [ Disabled ]**  
Hide Un-Configure ME without password Confirmation Prompt
- **MEBx Debug Message Output [ Disabled ]**
- **Un-Configure ME [ Disabled ]**  
Sets this item to [Disabled] to unconfigure AMT/ME without using a password or set it as [Enabled] to use a password.
- **Amt Wait timer [ 0 ]**
- **ASF [ Enabled ]**  
Enable/Disable Alert Specification Format
- **Active Remote Assistance Process [ Disabled ]**  
Trigger CIRA boot.
- **USB Provisioning of AMT [ Enabled ]**
- **PET Progress [ Enable ]**  
User can Enable/Disable PET Events progress to receive PET events or not.
- **AMT CIRA Timeout [ 0 ]**  
OEM defined timeout for MPS connection to be established.
- **Watchdog [ Disabled ]**  
When set to [Enabled], the Watchdog timer will monitor the time taken for each task performed by a software or hardware.
  - **OS Timer [ 0 ]**  
Set OS watchdog timer
  - **BIOS Timer [ 0 ]**  
Set BIOS watchdog timer.

### 3.2.2.6 PCH-FW Configuration



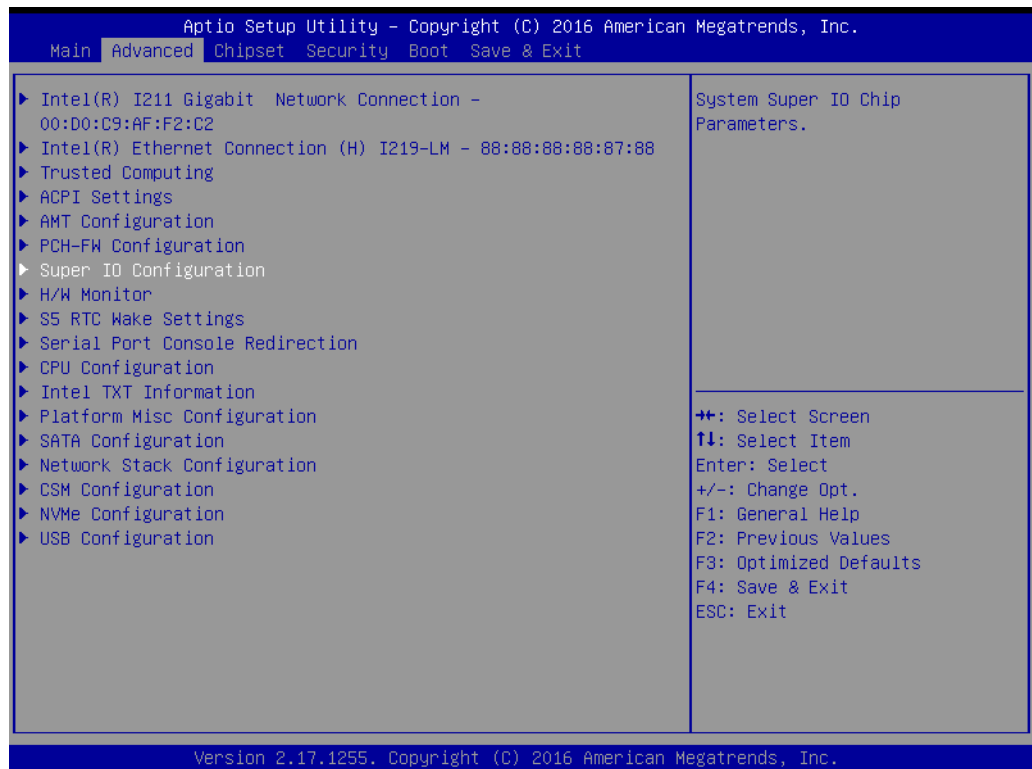
- **ME Unconfig on RTC Clear Status [ Enabled ]**
- **ME State [ Enabled ]**

## Firmware update Configuration

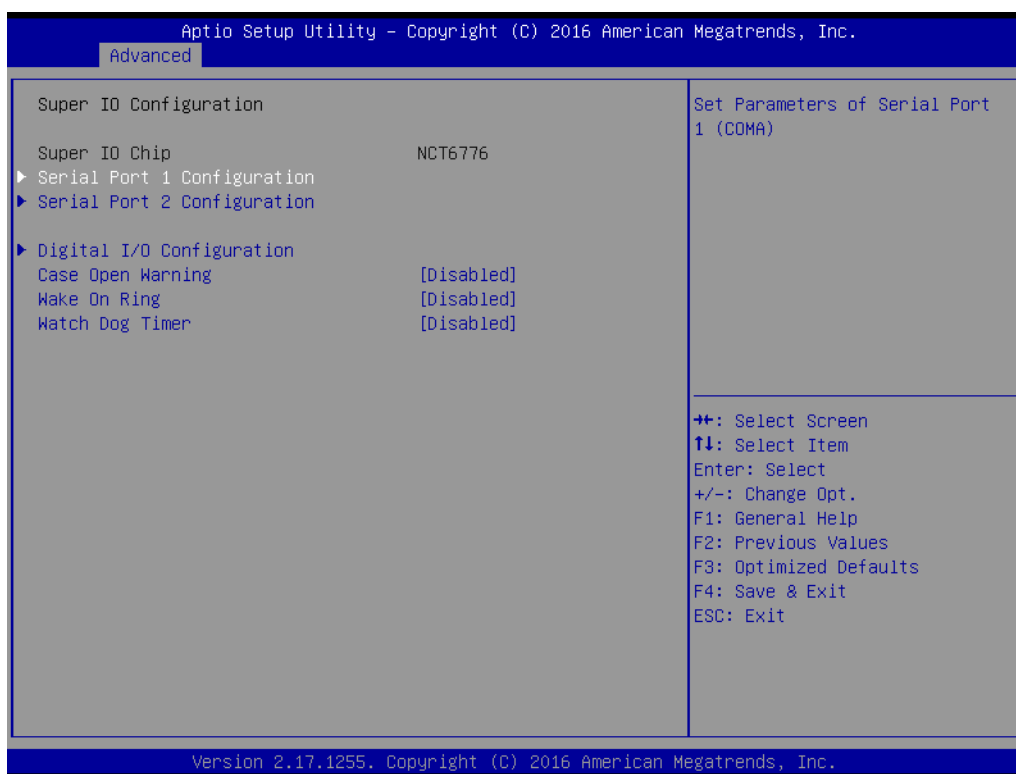


### ■ ME FW Image Re-Flash [ Disabled ]

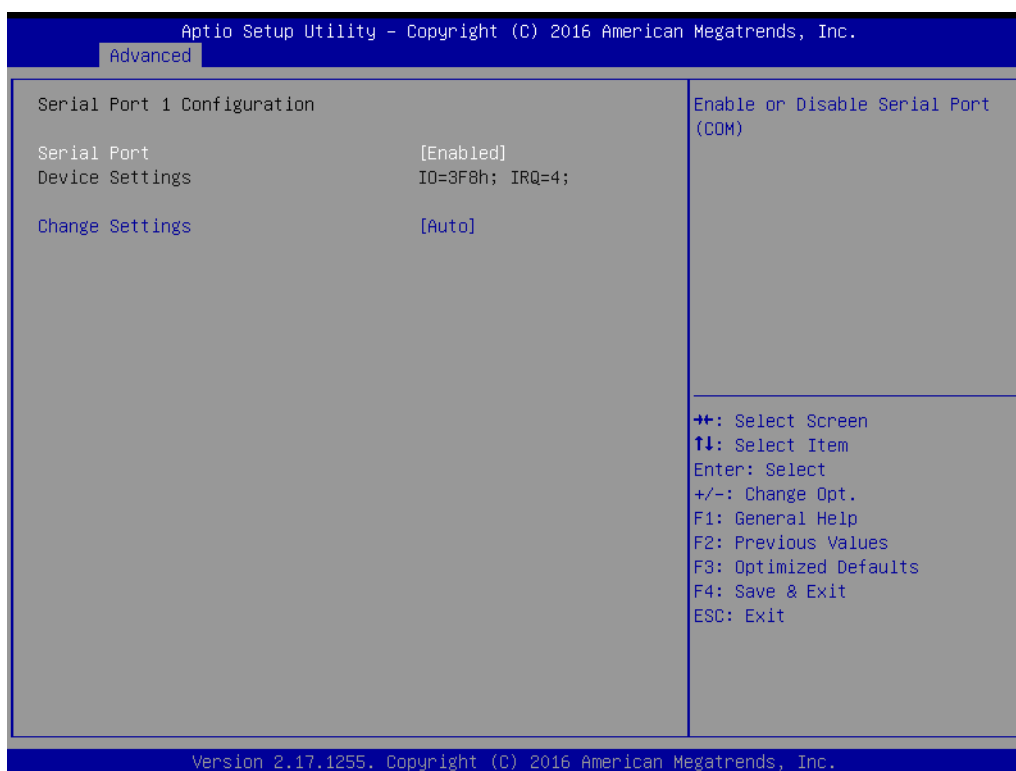
#### 3.2.2.7 Super IO Configuration





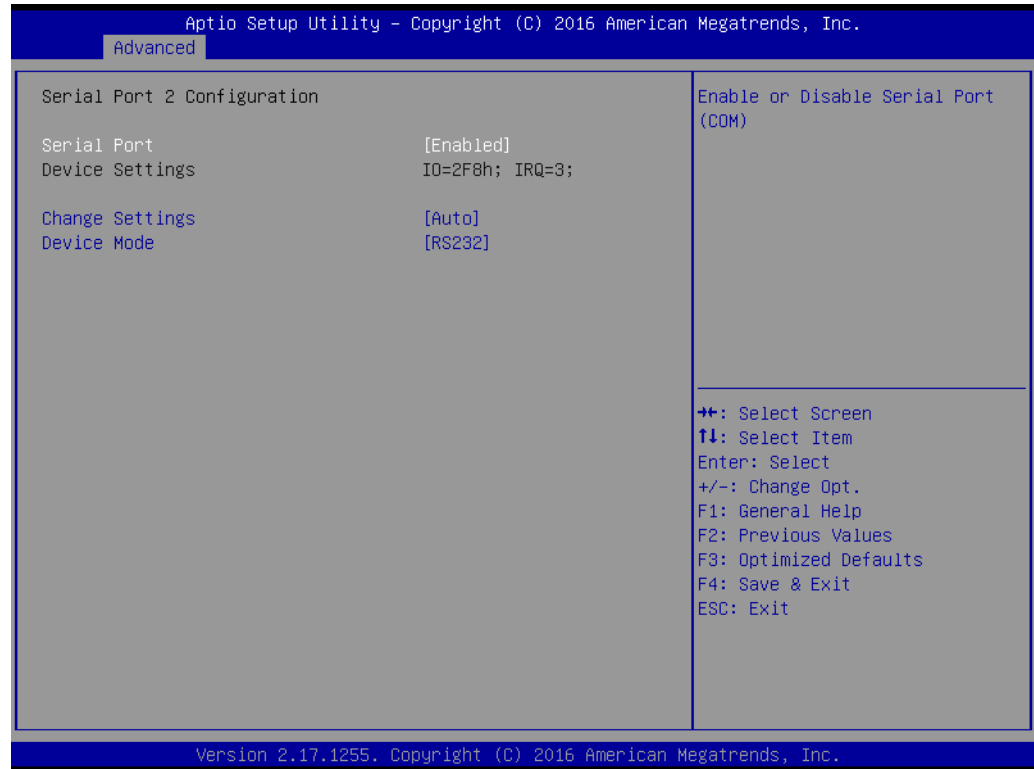


### ■ Serial Port 1 Configuration



- Serial Port [ Enabled ]
- Device Settings IO=3F8h; IRQ = 4
- Change Settings [ Auto ]

## Serial Port 2 Configuration

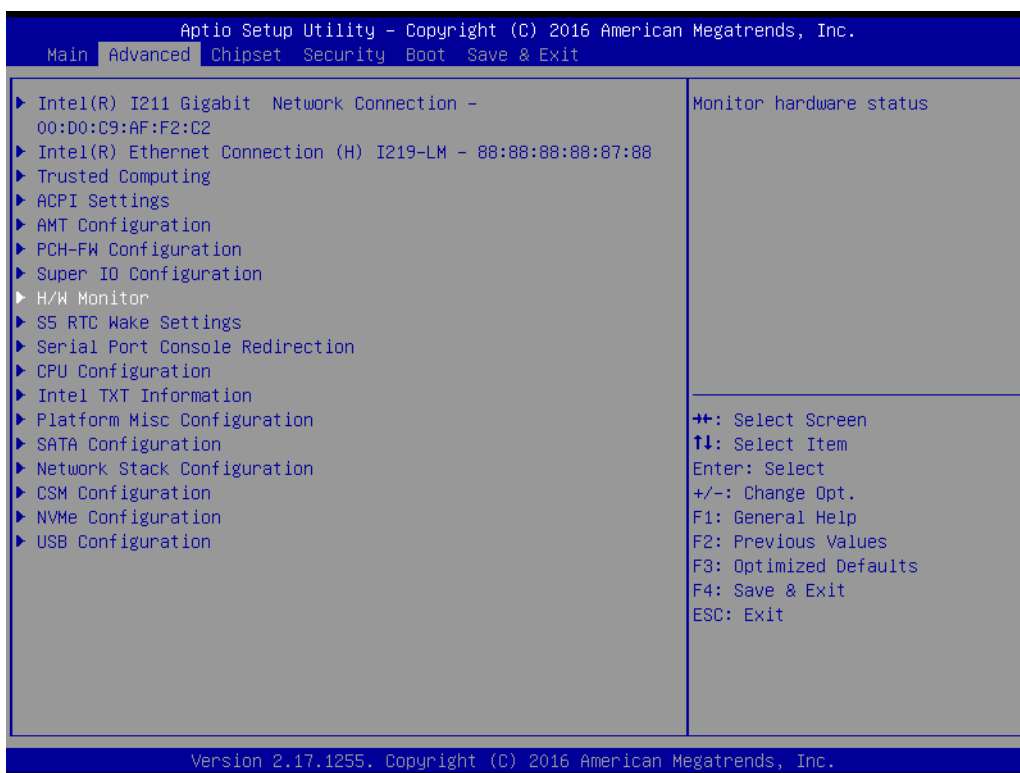


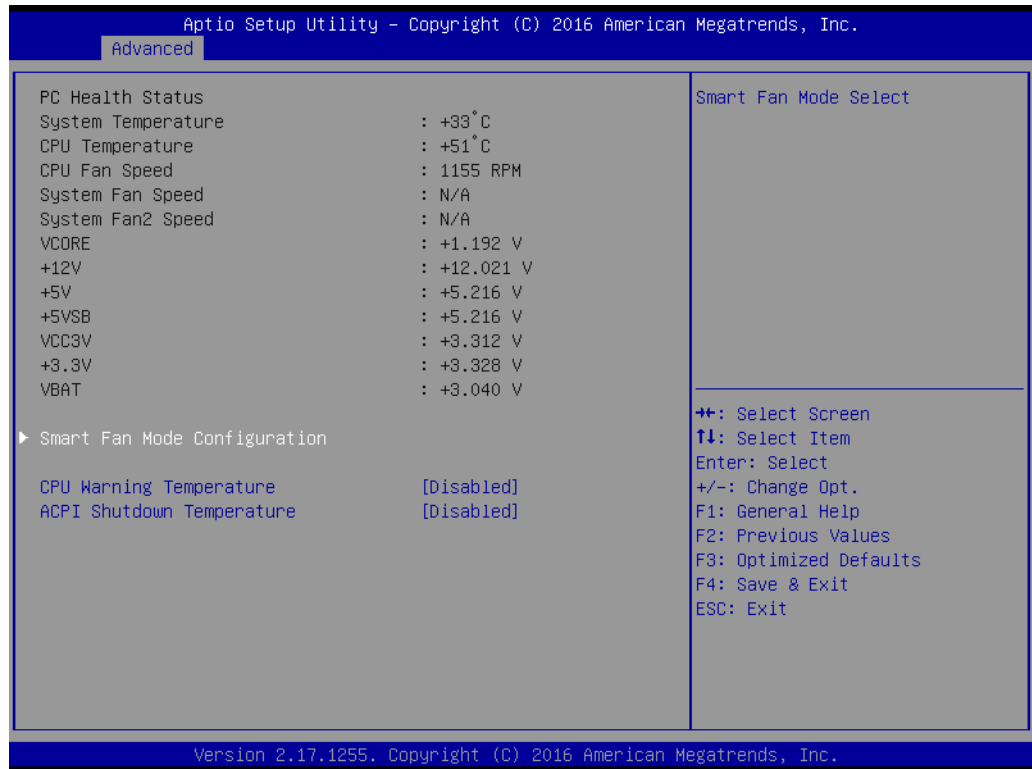
- **Serial Port [ Enabled ]**
- **Device Settings IO=2F8h; IRQ = 3**
- **Change Settings [ Auto ]**
- **Device Mode [ RS232 ]**

## Digital I/O Configuration



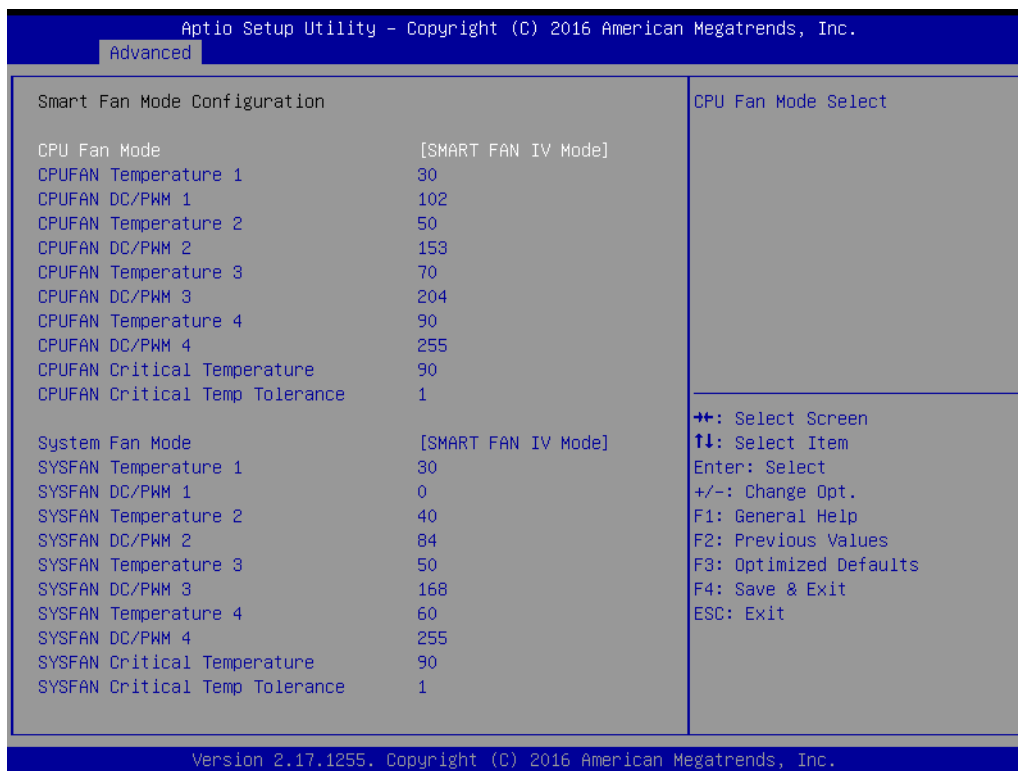
### 3.2.2.8 H/W Monitor





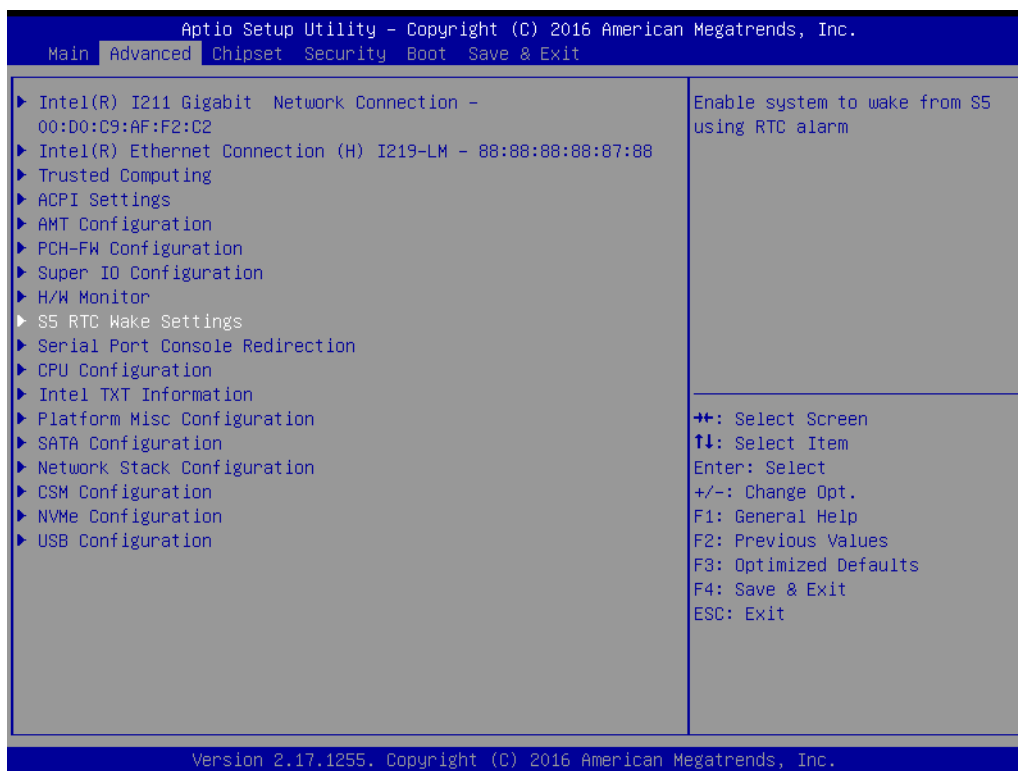
- **CPU Warning Temperature [ Disabled ]**  
 Use this to set the CPU warning temperature threshold. When the system reaches the warning temperature, the speaker will beep.
- **ACPI Shutdown Temperature [ Disabled ]**  
 Use this to set the ACPI shutdown temperature threshold. When the system reaches the shutdown temperature, it will be automatically shut down by ACPI OS to protect the system from overheating damage.

## Smart Fan Mode Configuration



### 3.2.2.9 S5 RTC Wake Settings

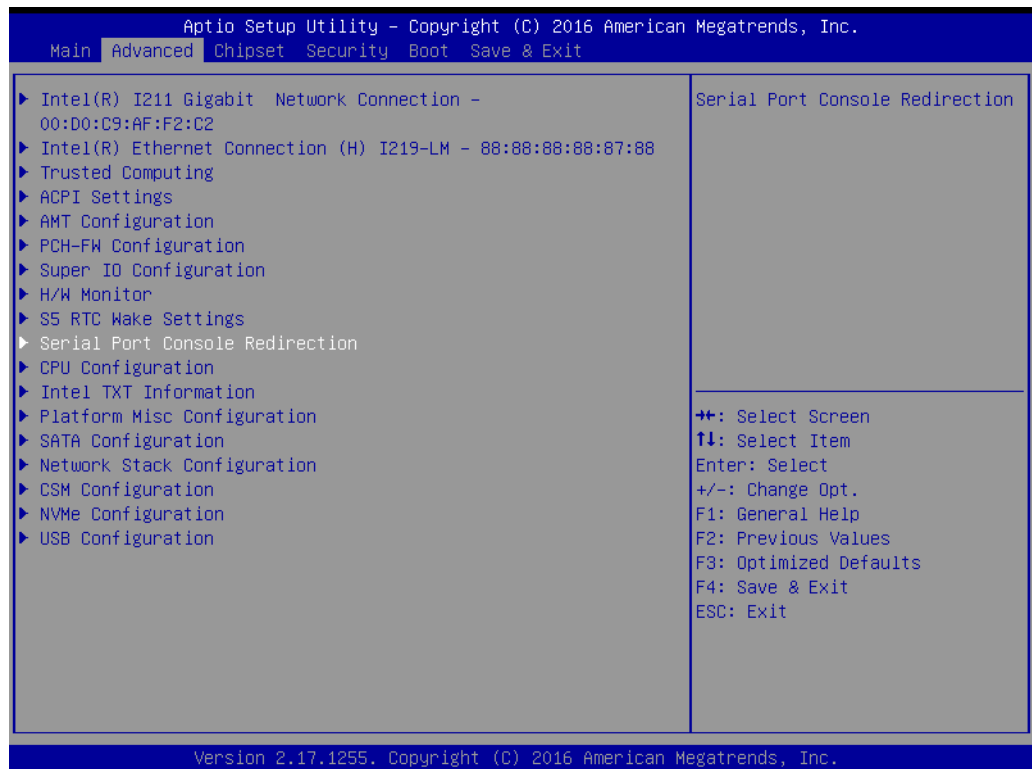
The item allows you enable or disable system wake up on alarm event.

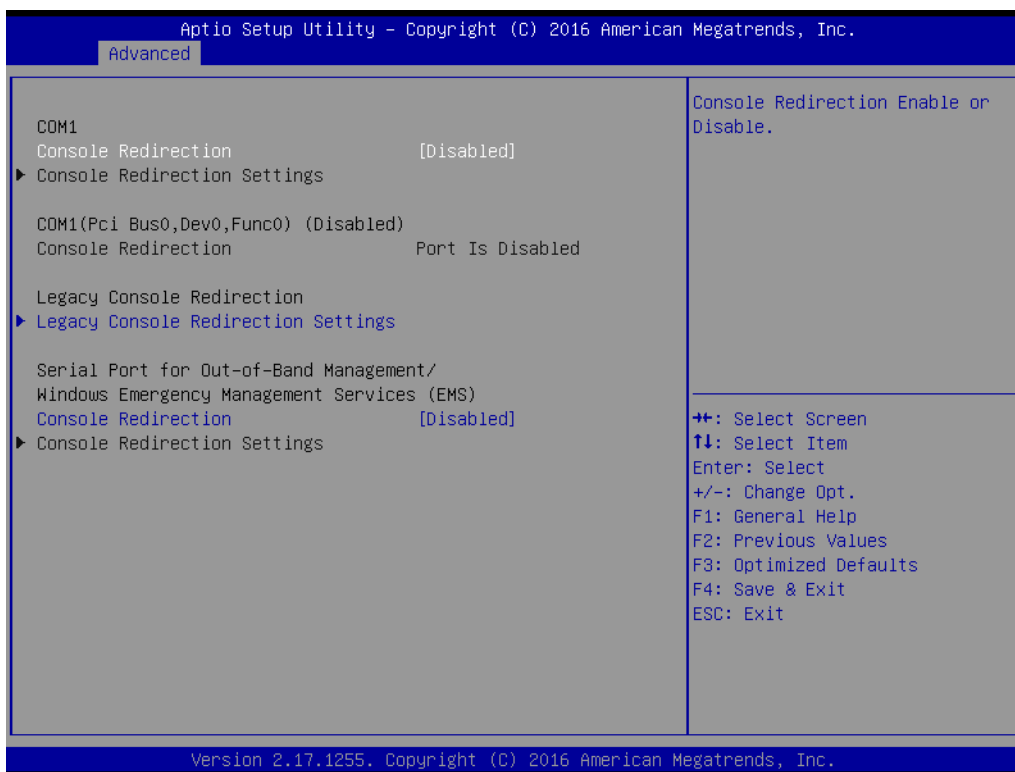




- **Wake system from S5 [ Disabled ]**  
 Enable or disable system wake on alarm event.
  - Select FixedTime: System will wake on the specific hr::min::sec.

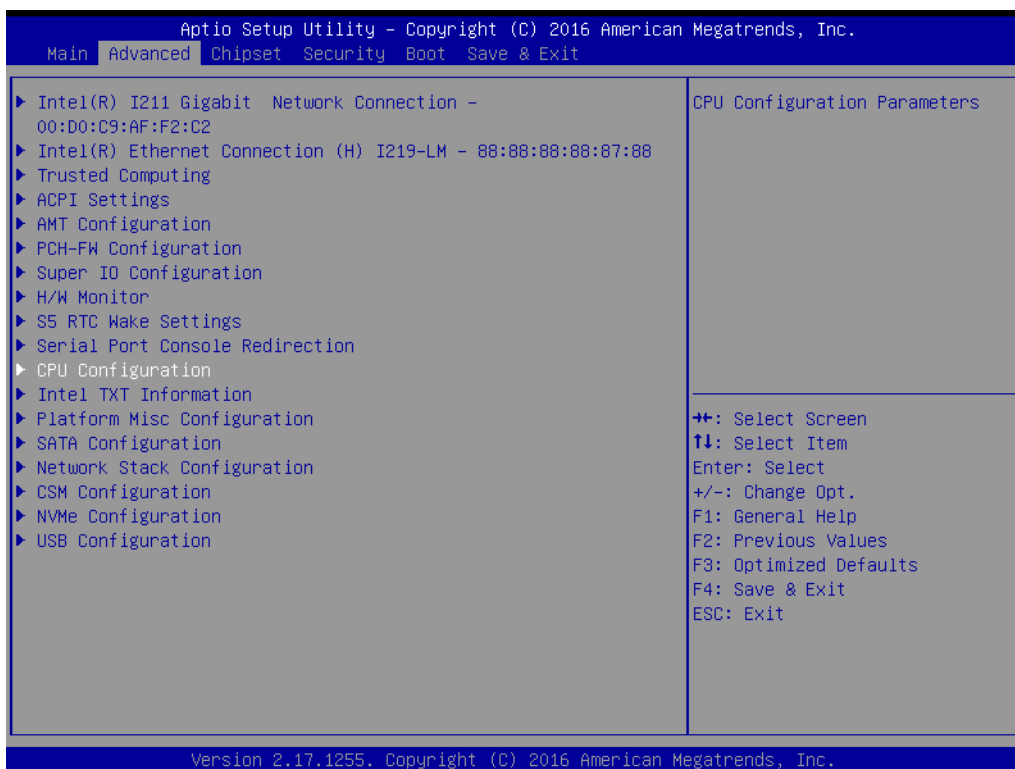
### 3.2.2.10 Serial Port Console Redirection





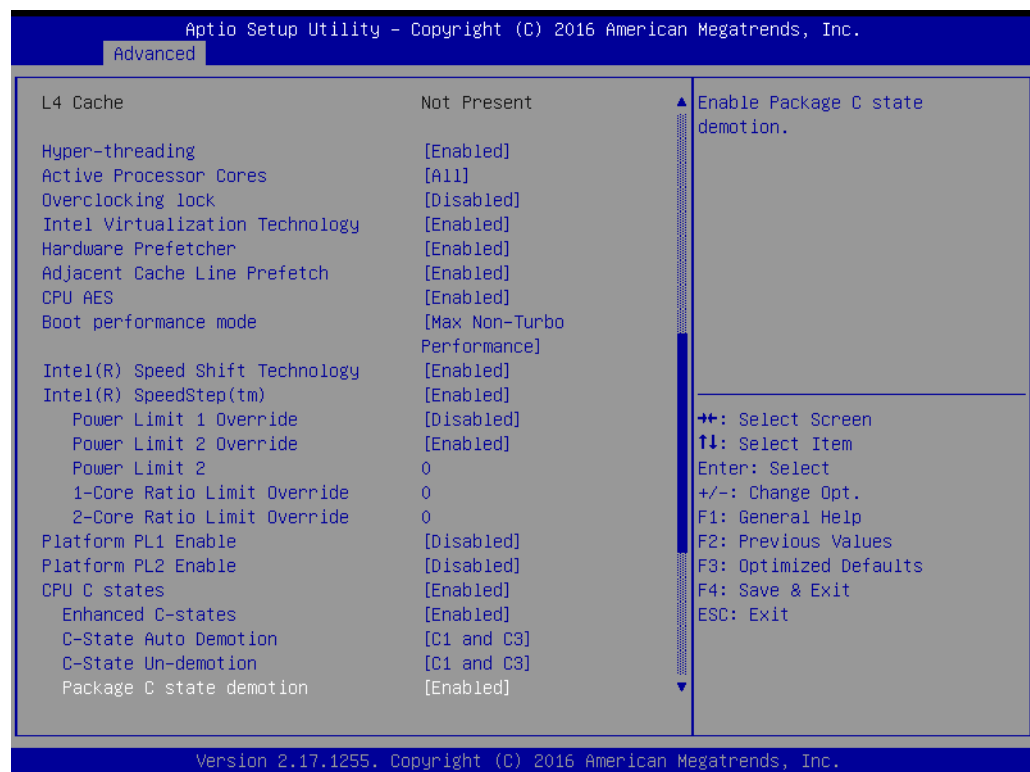
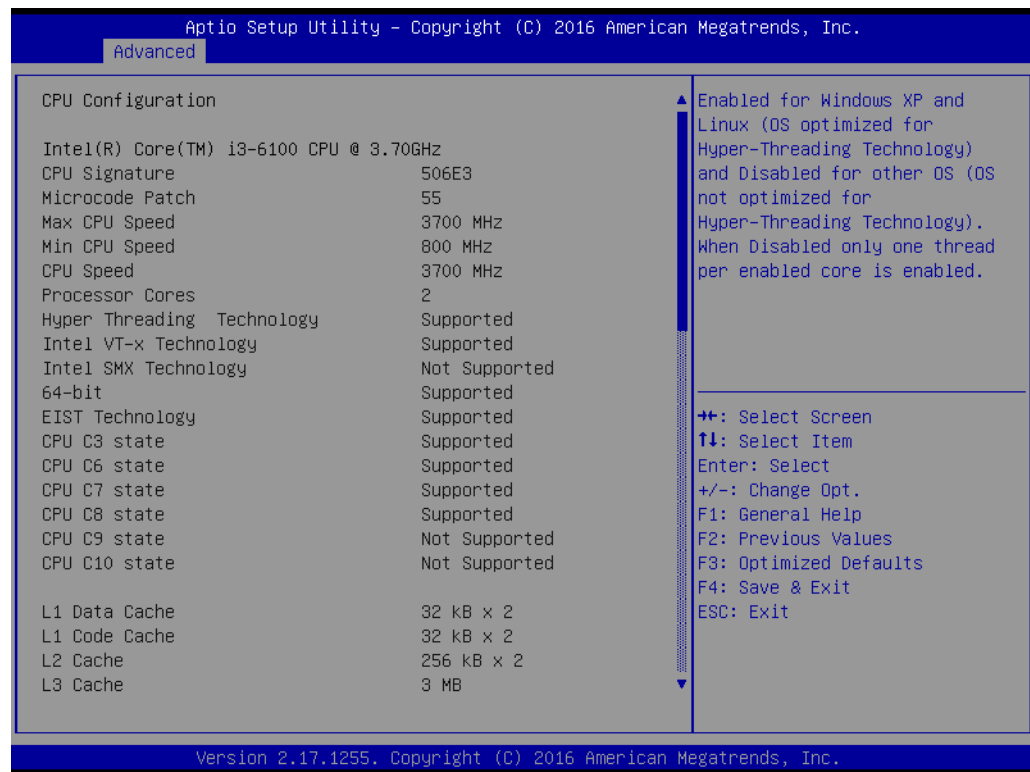
- **Console Redirection [ Disabled ]**  
Enable or disable the console redirection feature

### 3.2.2.11 CPU Configuration

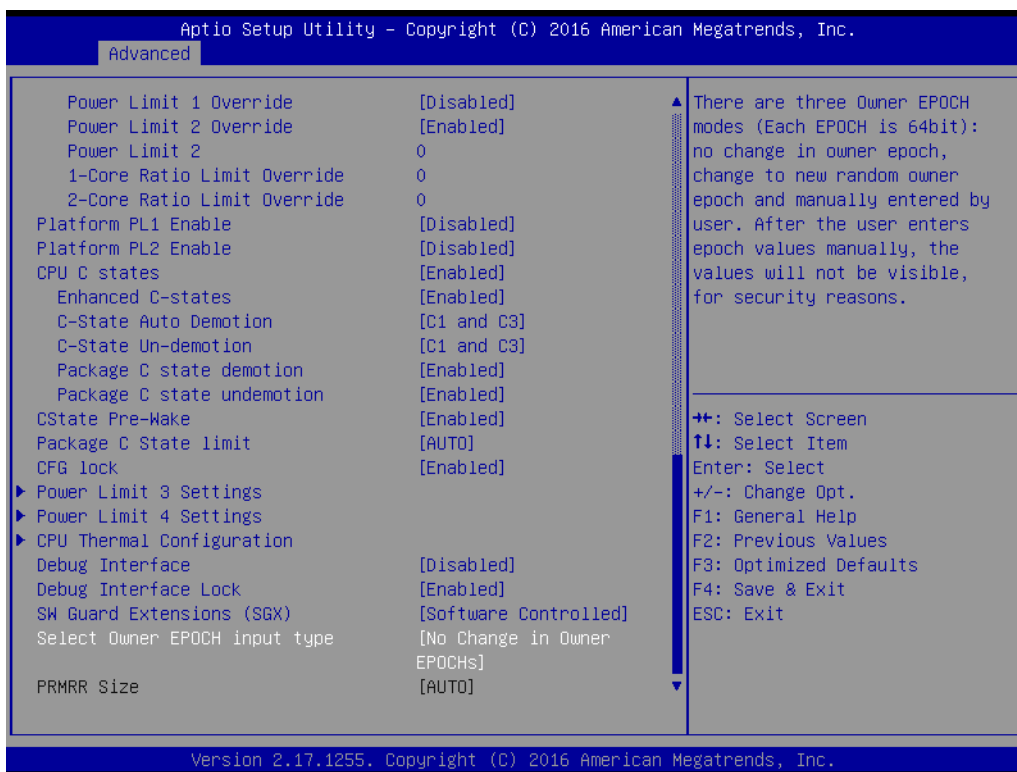


■ **CPU Configuration**

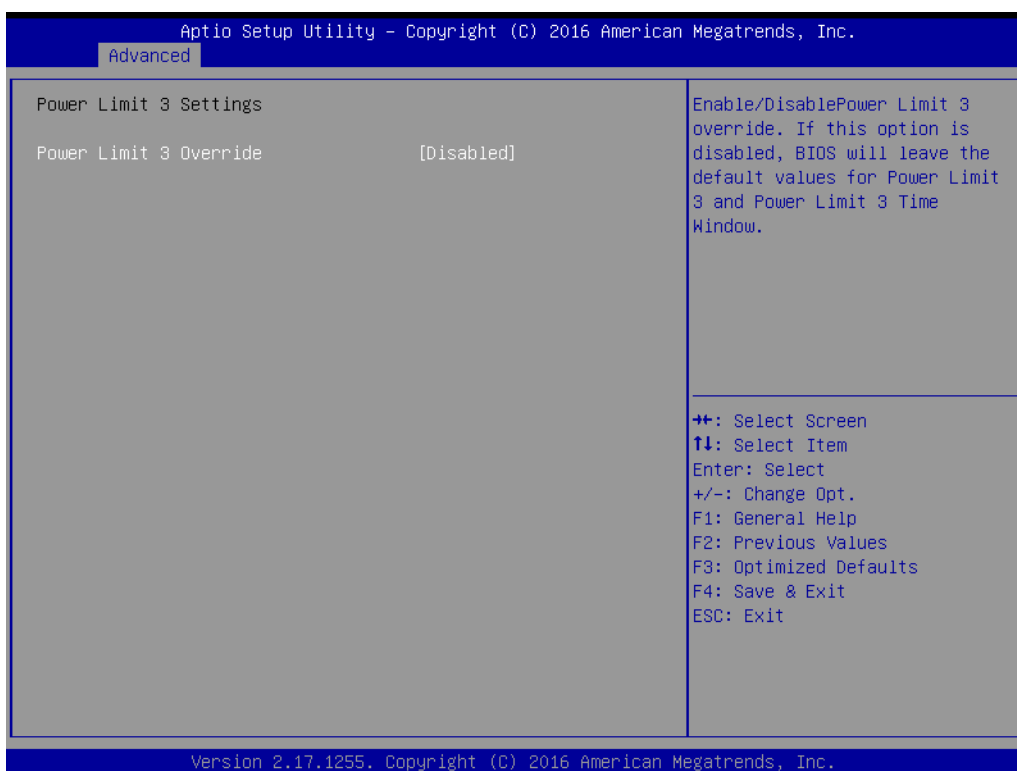
The item shows you CPU specification and feature; the content could be different by the different CPU.







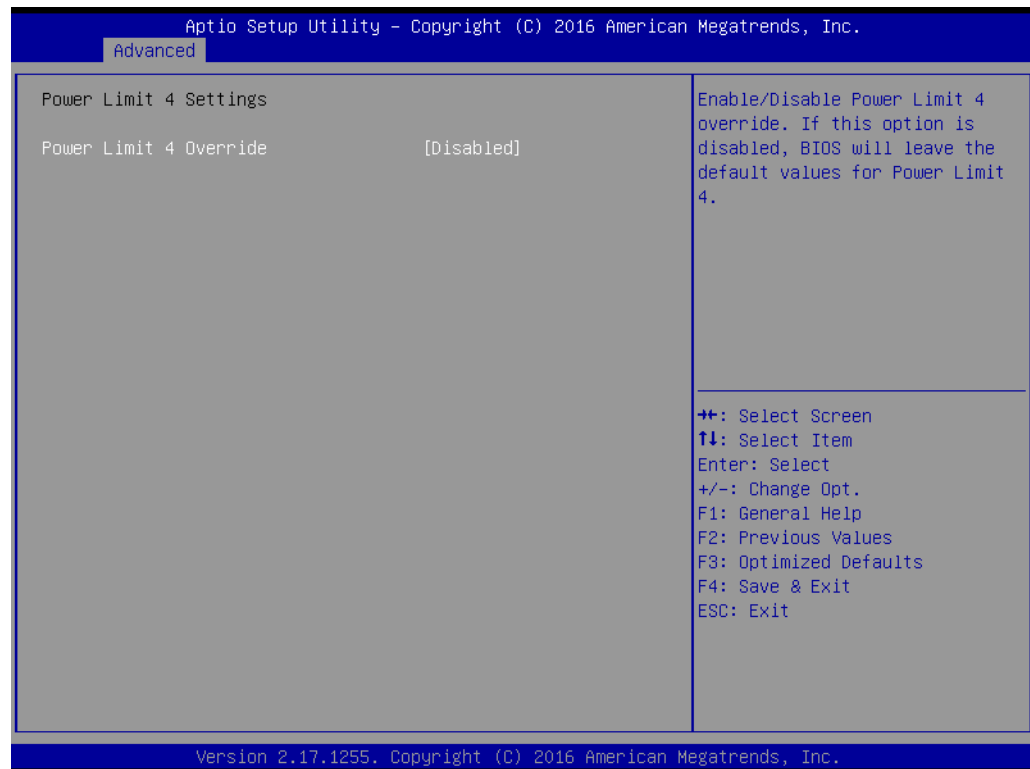
■ **Power Limit 3 Settings**



■ **Power Limit 3 Override [ Disabled ]**

If this option is enabled, BIOS will leave the default values for Power Limit 3 and Power Limit 3 Power Window.

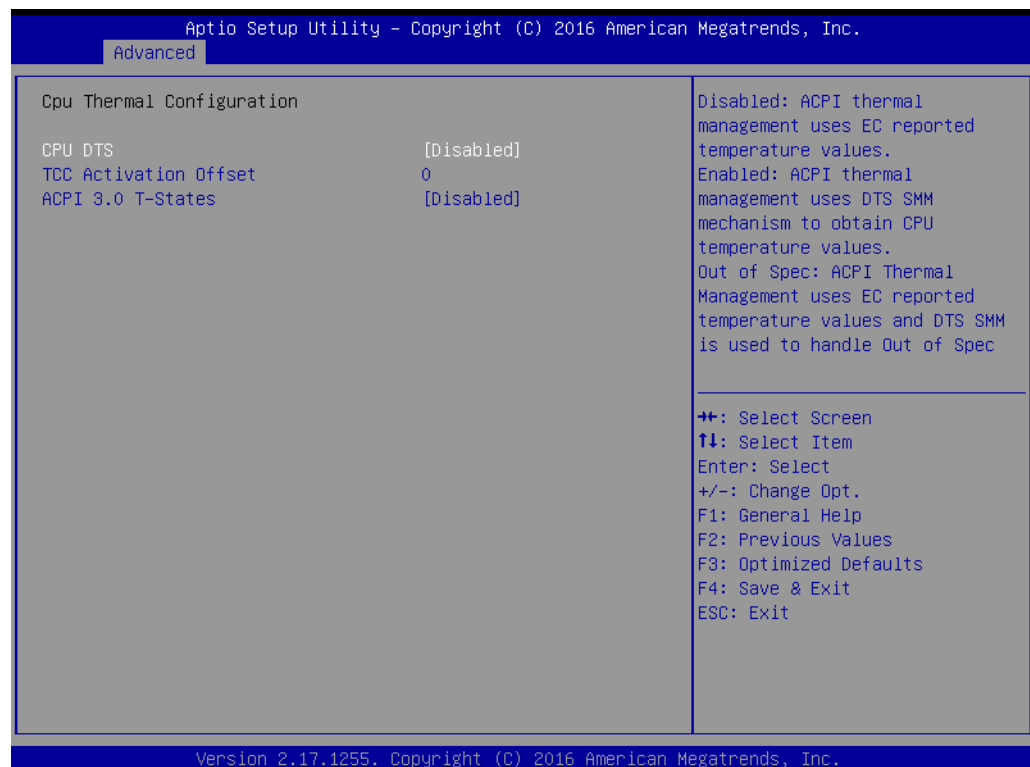
## ■ Power Limit 4 Settings



## ■ Power Limit 4 Override [ Disabled ]

If this option is enabled, BIOS will leave the default values for Power Limit 4.

## CPU Thermal Configuration



- **CPU DTOS [ Disabled ]**

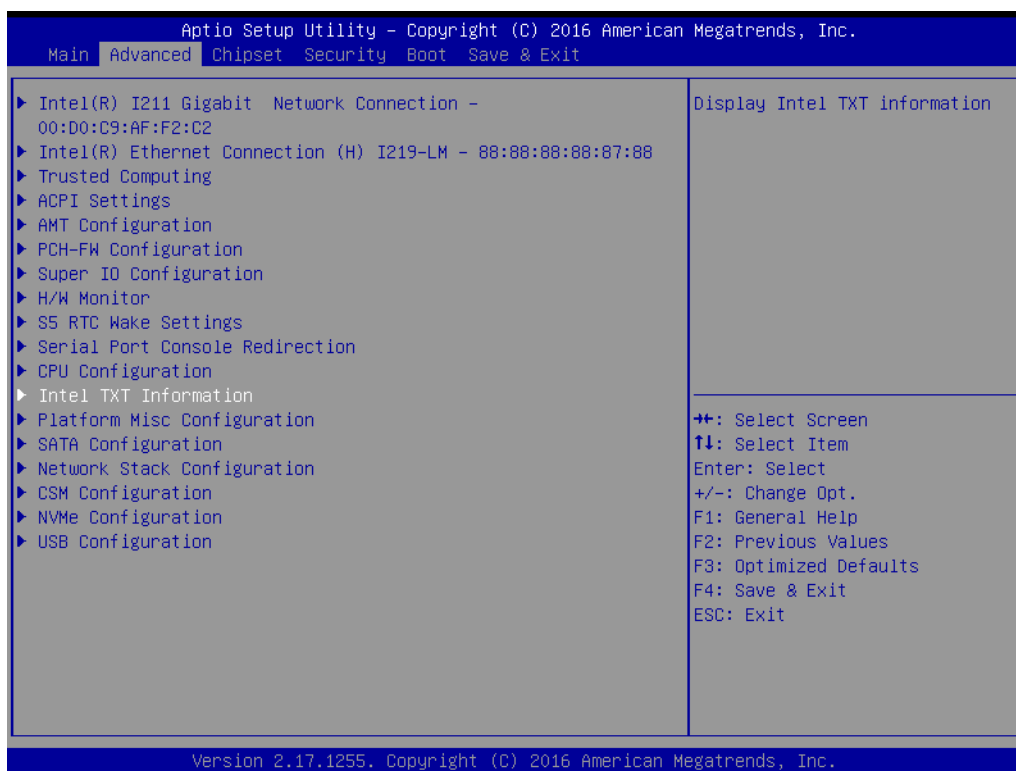
Disable: ACPI thermal management uses EC reported temperature values.

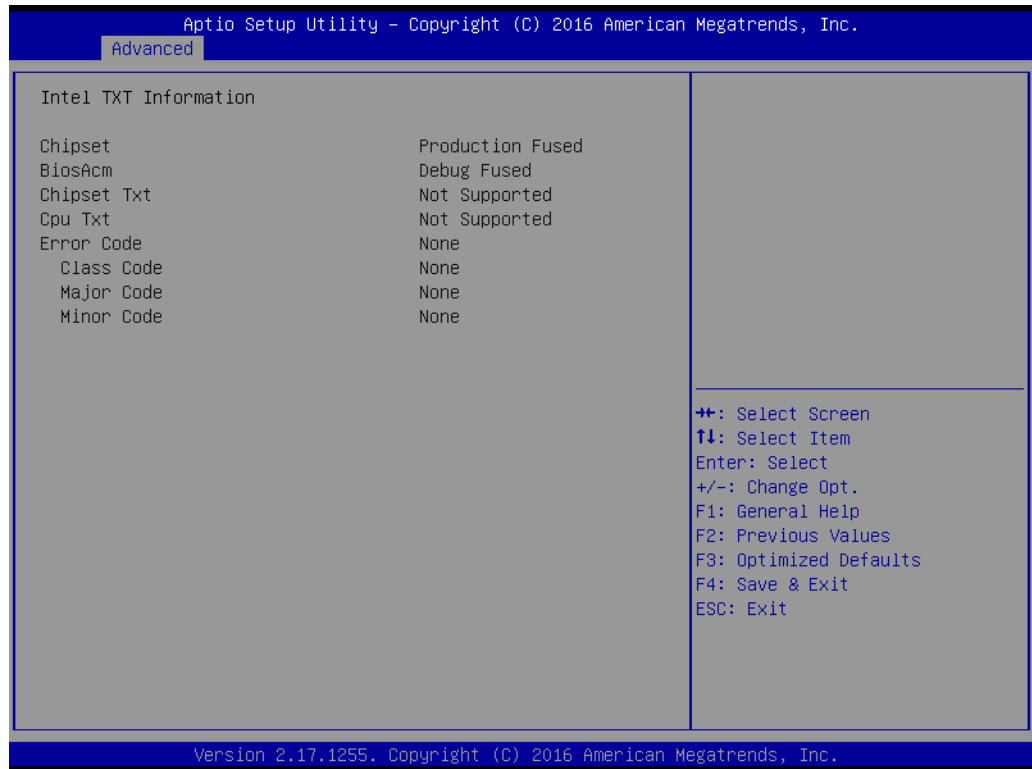
Enable: ACPI thermal management use DTS SMM mechanism to obtain CPU temperature values.

Out of Spec: ACPI thermal management use EC reported temperature values and DTS SMM mechanism is used to handle Out of Spec.

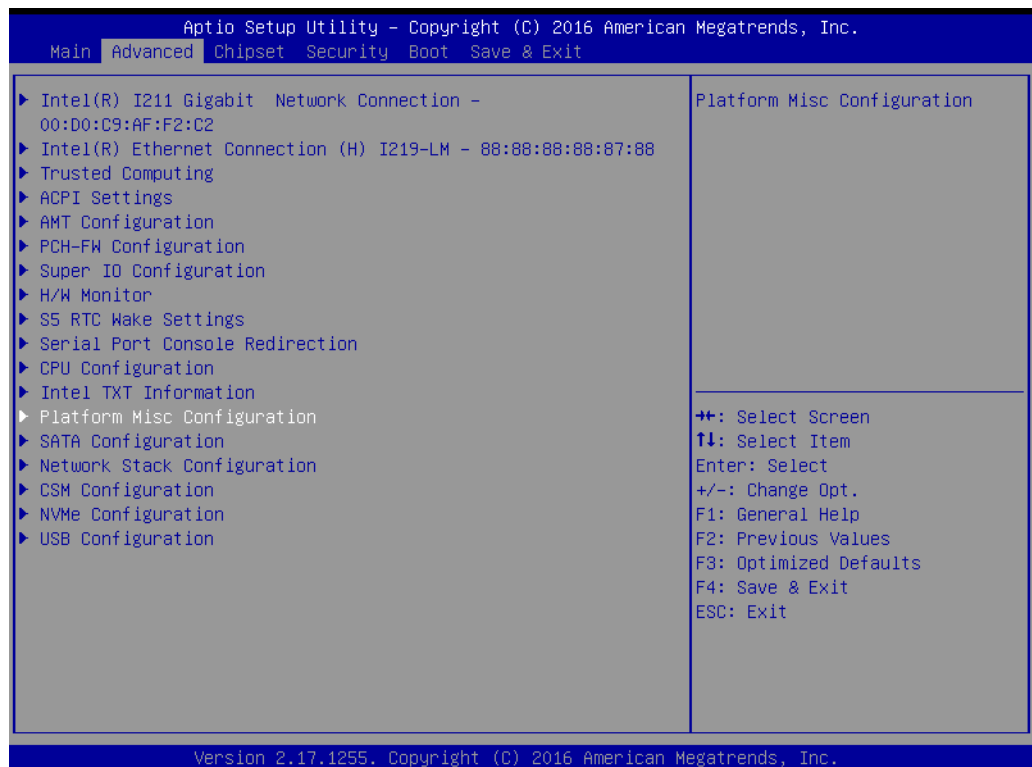
- **ACPI 3.0 T-States [ Disabled ]**

### 3.2.2.12 Intel TXT Information





### 3.2.2.13 Platform Misc Configuration





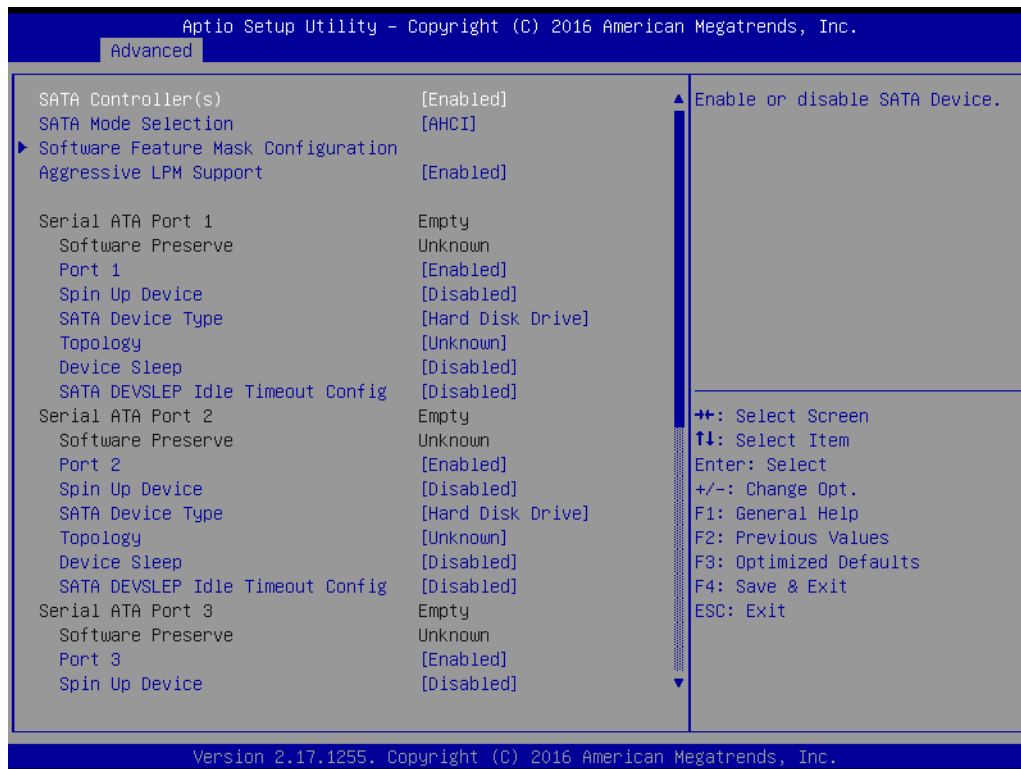
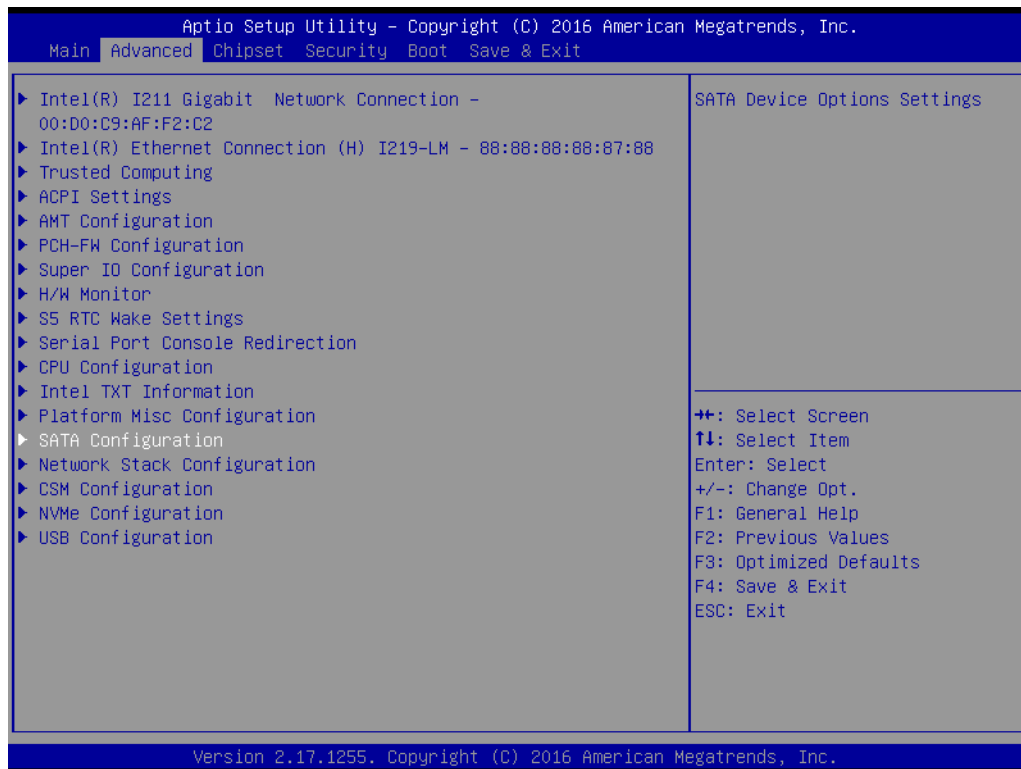
- **Native PCIE Enable [ Enabled ]**

**Note!** *PCI Express Native support is only available in Vista.*



- **Native ASPM [ Auto ]**  
BOAT ACPI Table Support [ Disabled ]
- **PCI Delay Optimization [ Disabled ]**

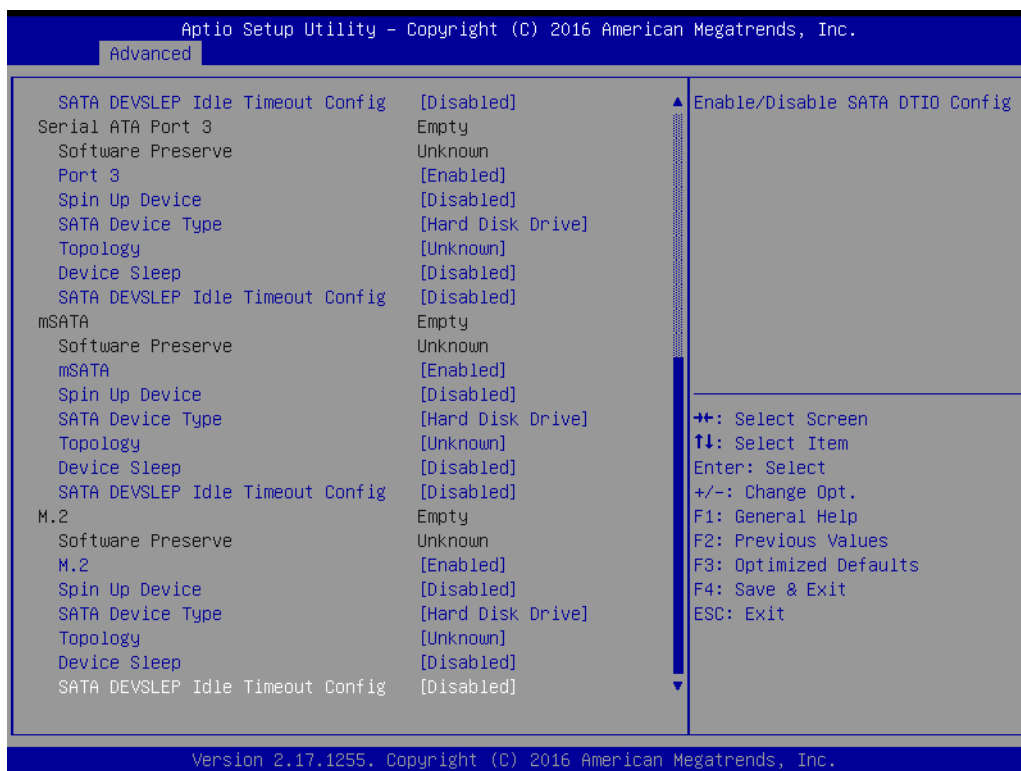
### 3.2.2.14 SATA Configuration



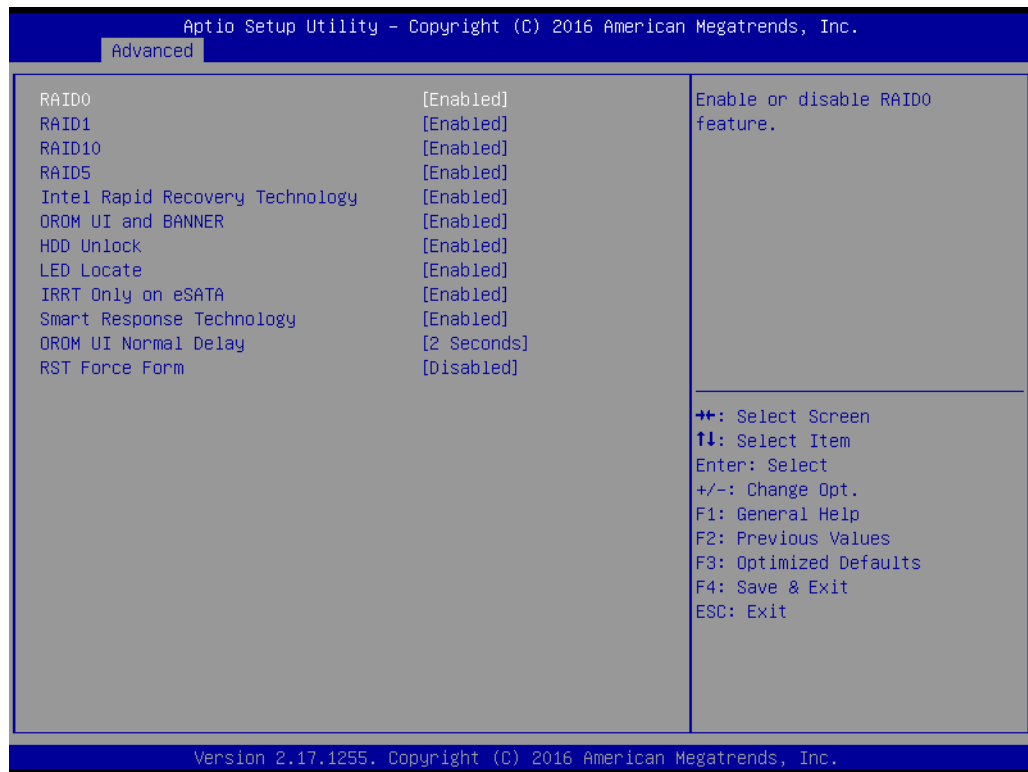
- **SATA Controllers [ Enabled ]**
- **SATA Mode Selection [ AHCI ]**
- **Aggressive LPM Support [ Enabled ]**
- **Serial ATA Port 1 [ Enabled ]**
- **Serial ATA Port 2 [ Enabled ]**

- Serial ATA Port 3 [ Enabled ]
- mSATA [ Enabled ]
- M.2 [ Enabled ]

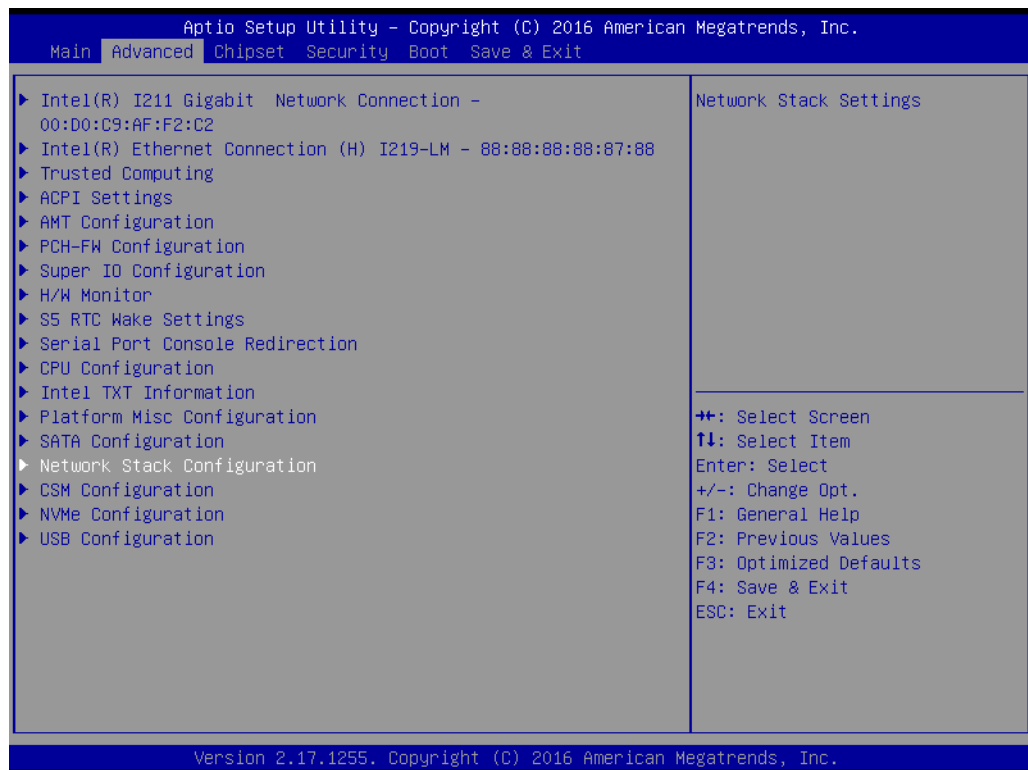
**Note!** AIMB-275 M.2 B\_Key supports NGFF (Next Generation Form Factor) Storage and 3G device. Not compatible with M.2 WIFI, Bluetooth device.



## Software Feature Mask Configuration



### 3.2.2.15 Network Stack Configuration

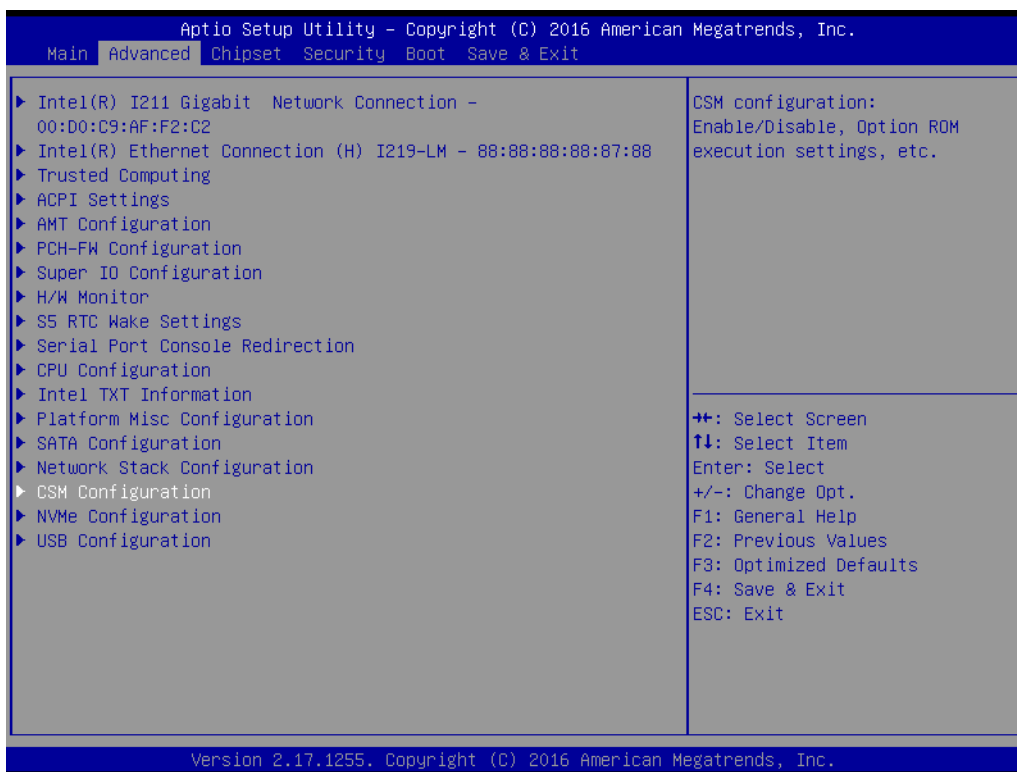


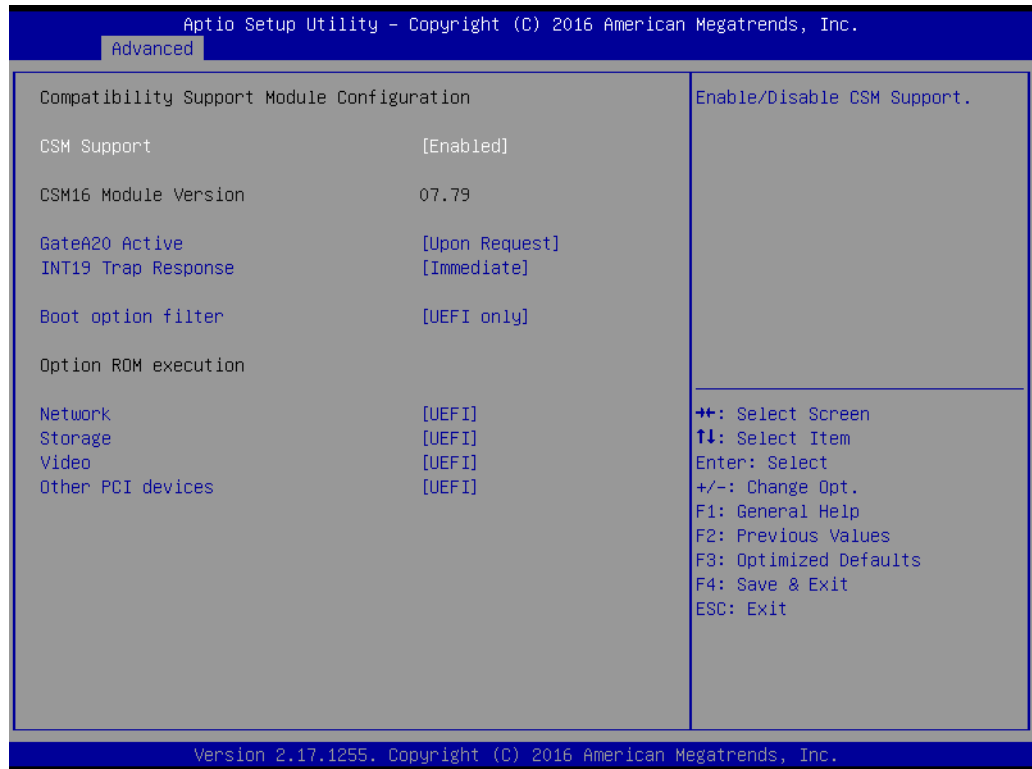




- **Network Stack [ Disabled ]**  
Enable / Disable UEFI Network Stack

### 3.2.2.16 CSM Configuration





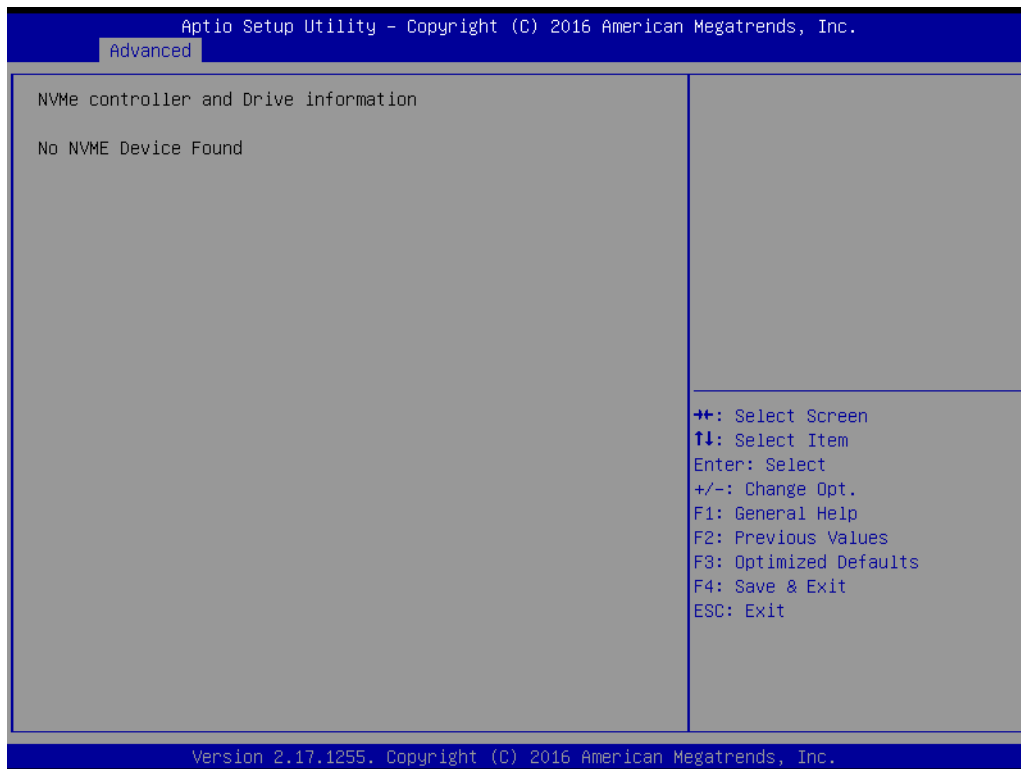
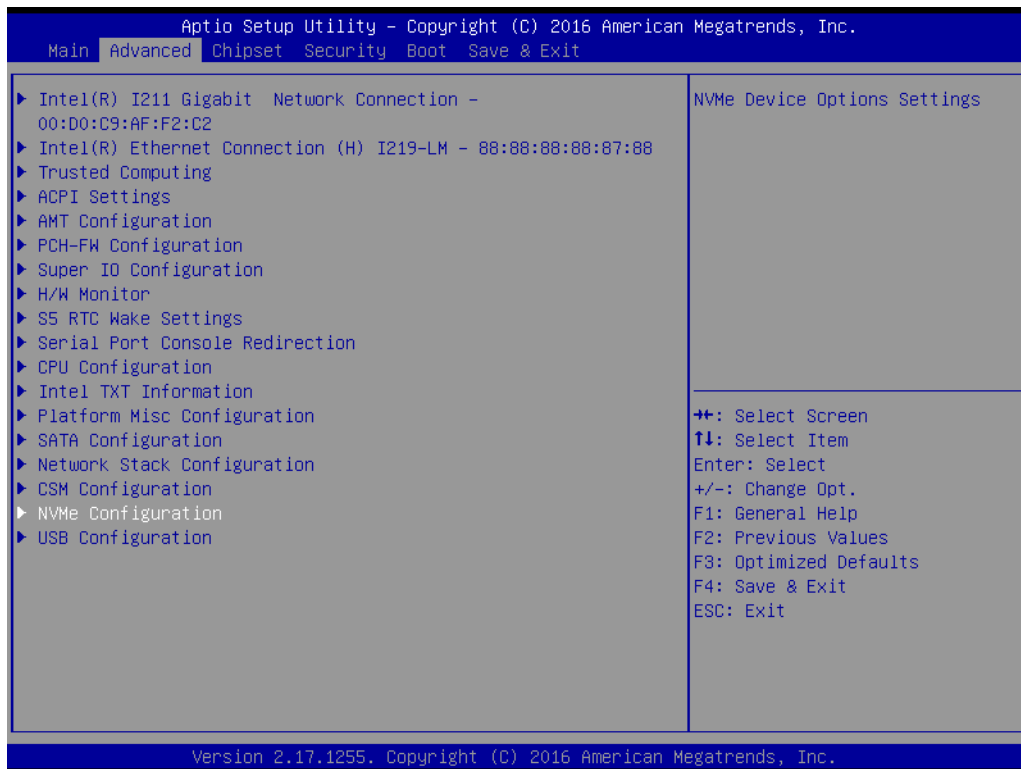
- **CSM Support [ Enabled ]**
- **Boot option filter [ UEFI only ]**
- **Option ROM execution**
  - Network [ UEFI ]
  - Storage [ UEFI ]
  - Video [ UEFI ]
  - Other PCI device [ UEFI ]

**Note!** *If your HDD or other boot device is installed as Legacy mode, it may cause blue screen situation. There are 2 ways to solve this:*

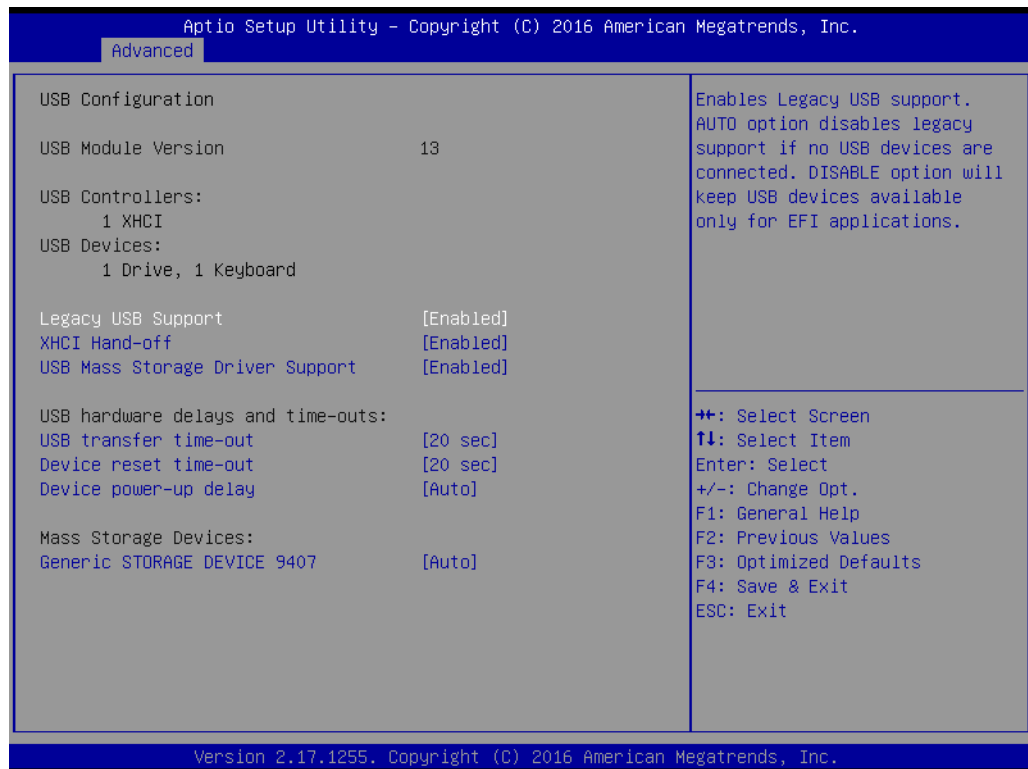
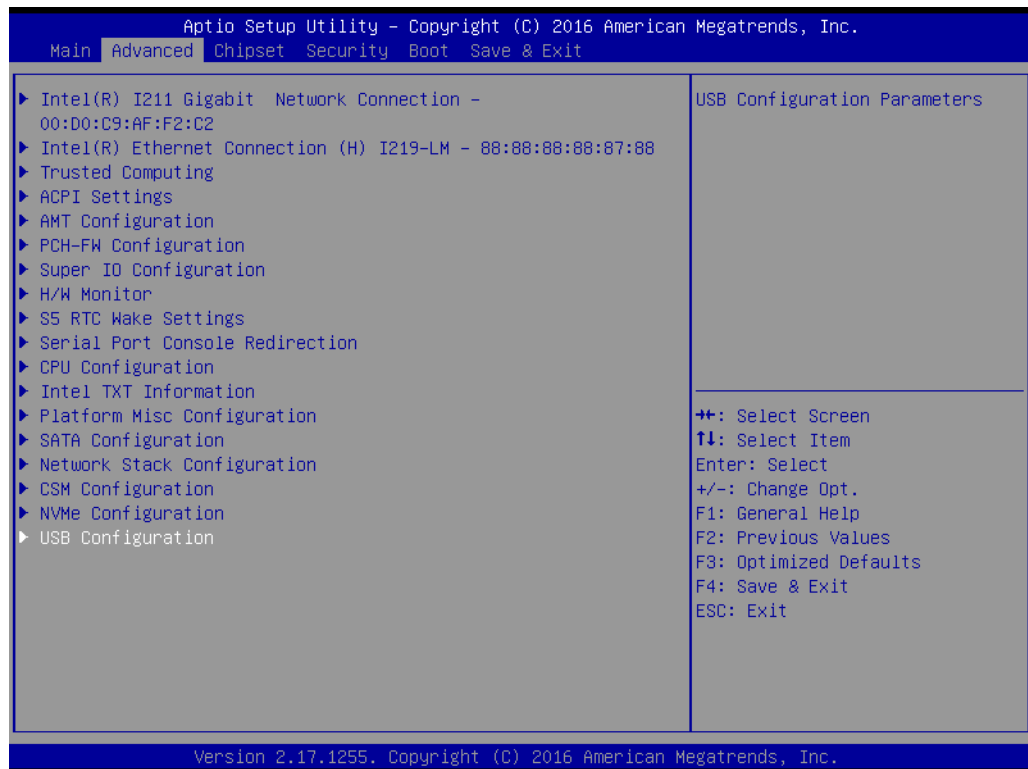


1. *Re-install your OS as UEFI Mode*
2. *Change all of settings above as " Legacy"*
  - *Boot option filter → Legacy Only*
  - *Network → Legacy*
  - *Storage → Legacy*
  - *Video → Legacy*
  - *Other PCI devices → Legacy*

## 3.2.2.17 NVMe Configuration



### 3.2.2.18 USB Configuration

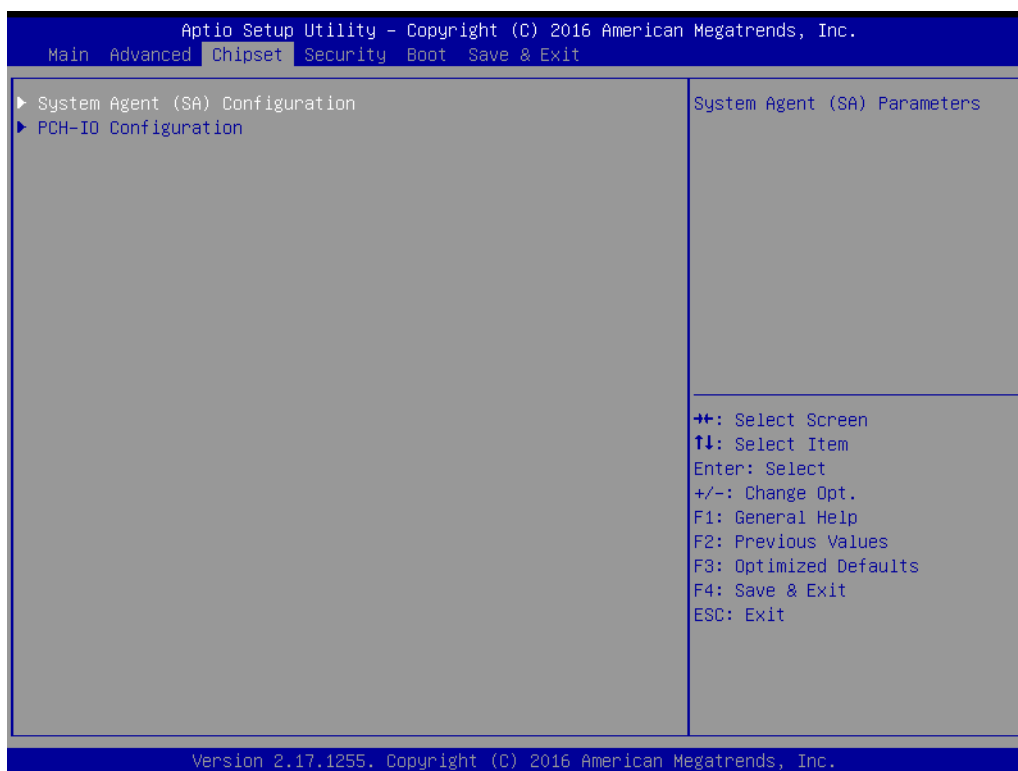


- **Legacy USB Support [ Enabled ]**  
Enables support for legacy USB. Auto option disables legacy support if no USB devices are connected.
- **XHCI Hand-off [ Enabled ]**  
USB Mass Storage Driver Support [ Enabled ]

- **USB hardware delays and time-outs**  
USB Device transfer & reset time-out and delay setting.
- **Mass Storage Devices [ Auto ]**  
Auto detects the USB device you connected to and shows USB mass storage device information.

### 3.2.3 Chipset Configuration Setting

Select the chipset tab from the BIOS setup screen to enter the Chipset Setup screen. Users can select any item in the left frame of the screen, such as PCI express Configuration, to go to the sub menu for that item. Users can display a Chipset Setup option by highlighting it using the <Arrow> keys. All Chipset Setup options are described in this section. The Chipset Setup screens are shown below. The sub menus are described on the following pages.

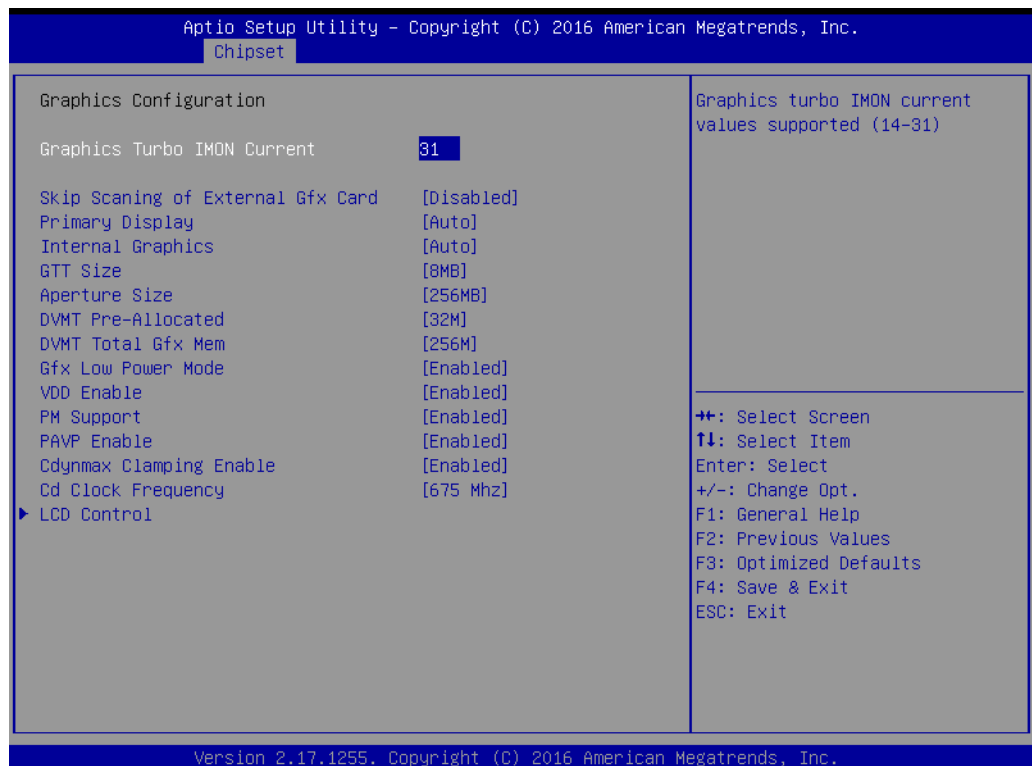


### 3.2.3.1 System Agent (SA) Configuration



- **VT-d [ Enabled ]**  
Disable or enable VT-d capability.
- **Above 4GB MMIO BIOS assignment [ Disabled ]**

### Graphics Configuration



- **Graphics Turbo IMON Current [ 31 ]**  
Graphics turbo IMON Current values supported (14-31 ).
- **Primary Display [ Auto ]**  
Select which IGFX/PEG/PCI Graphics device should be Primary Display
- **Internal Graphics [ Auto ]**  
Keep IGD enabled based on the setup options.
- **GTT Size [ 8MB ]**
- **Aperture Size [ 256MB ]**
- **DVMT Pre-Allocated [ 32M ]**  
Select DVMT 5.0 Pre-Allocated (Fixed) Graphics Memory size used by the Internal Graphics Device.
- **DVMT Total Gfx Mem [ 256M ]**  
Select DVMT5.0 Total Graphic Memory size used by the Internal Graphics Device.
- **Gfx Low Power Mode [ Enabled ]**

**Note!** This option is applicable for SFF only



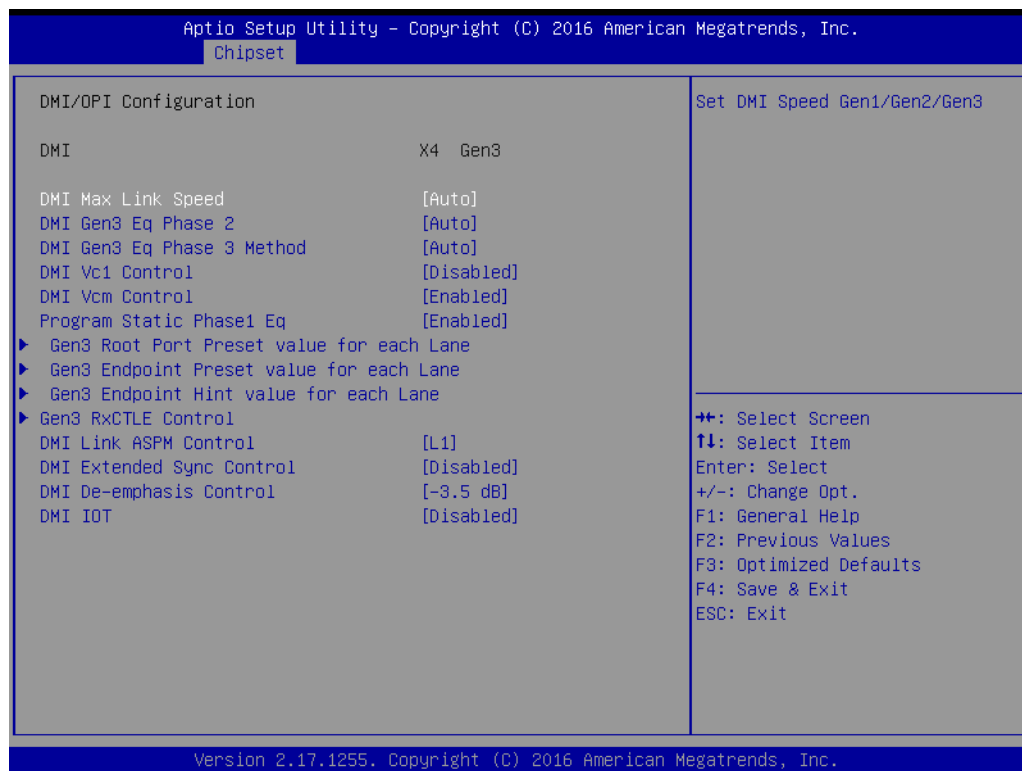
- **VDD Enable [ Enabled ]**
- **PM Support [ Enabled ]**
- **PAVP Enable [ Enabled ]**
- **Cdynmax Clamping Enable [ Enabled ]**
- **Cd Clock Frequency [ 675 Mhz ]**

## LCD Control



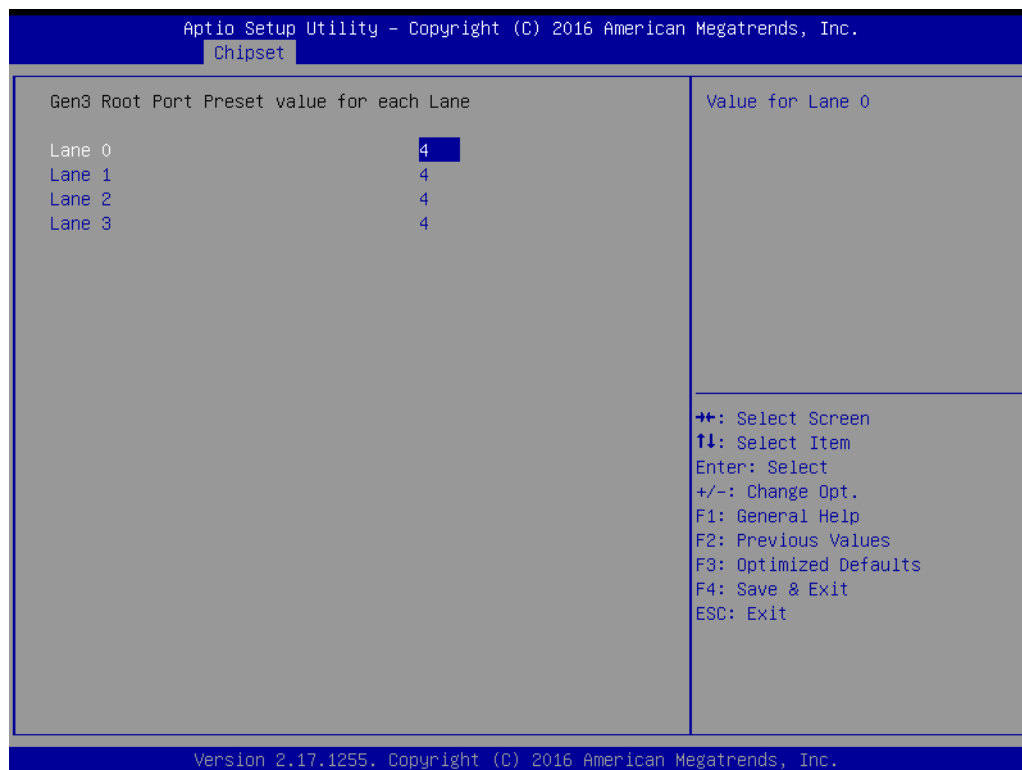
- **LVDS Panel Type [ Disabled ]**

## DMI/ OPI Configuration



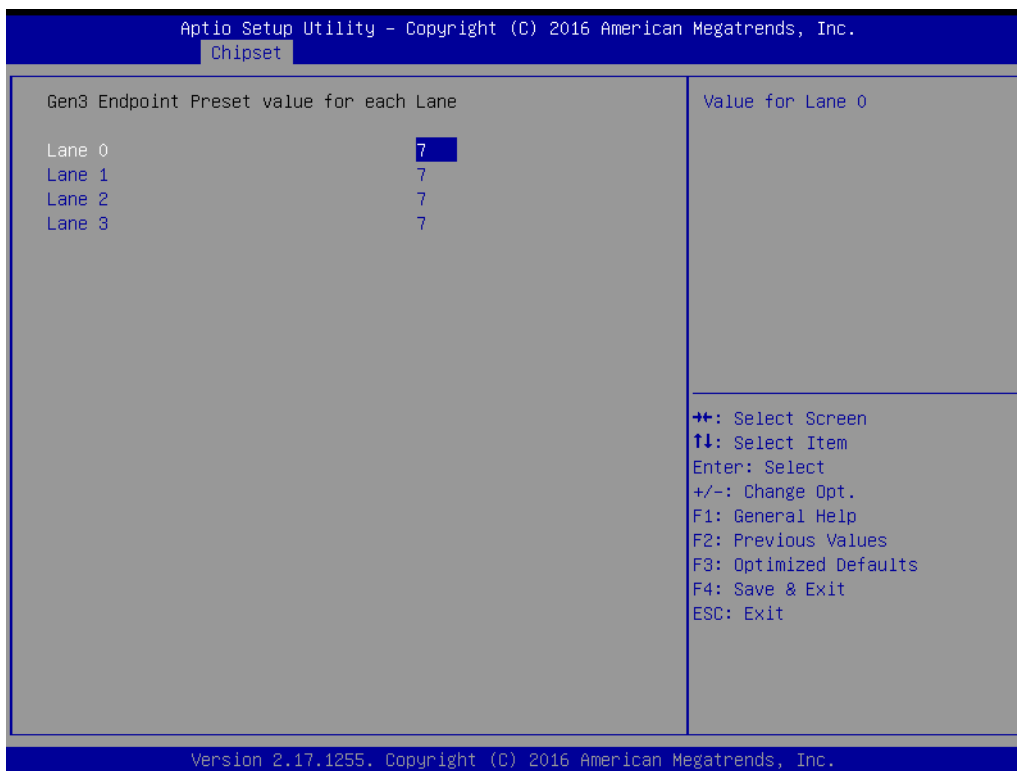
- **DMI Max Link Speed [ Auto ]**  
Set DMI Speed at Gen1/ Gen2/ Gen3.

## Gen3 Root Port Press Value for each Lane





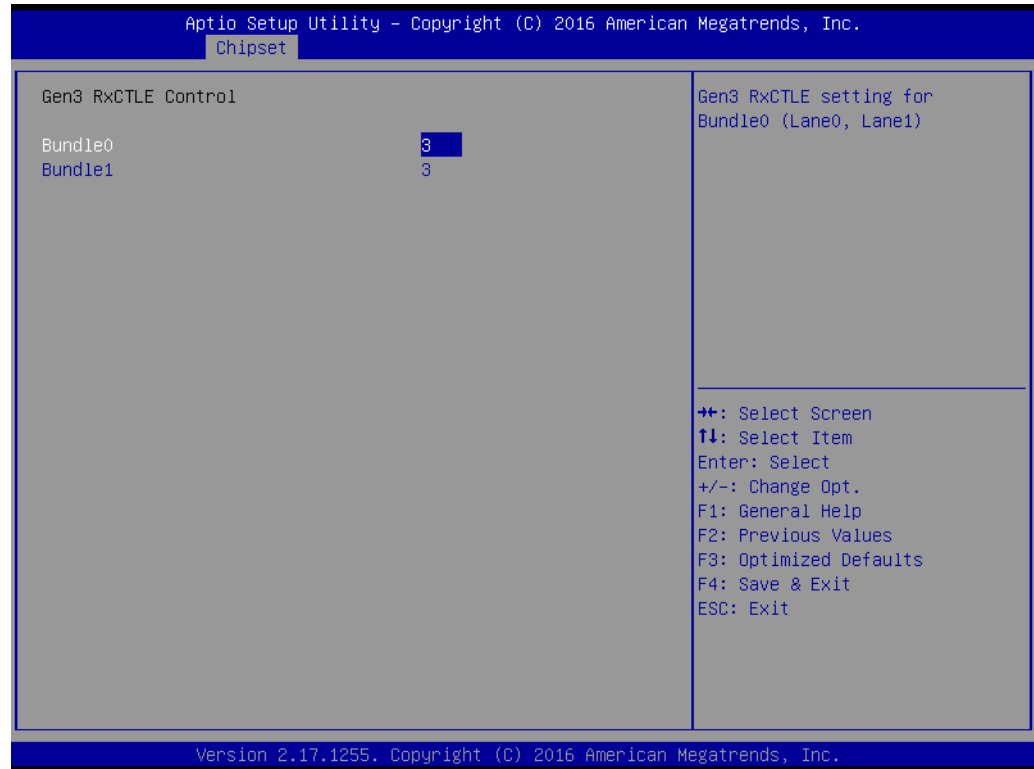
### Gen3 Endpoint Preset value for each Lane



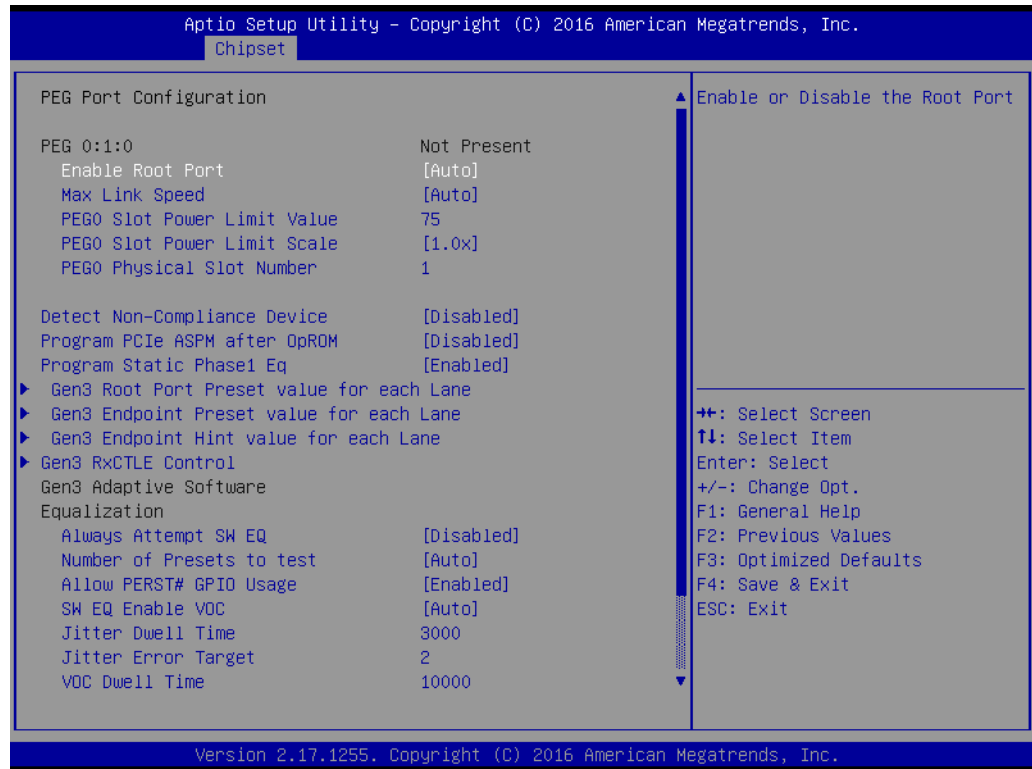
### Gen3 Endpoint Hint value for each Lane

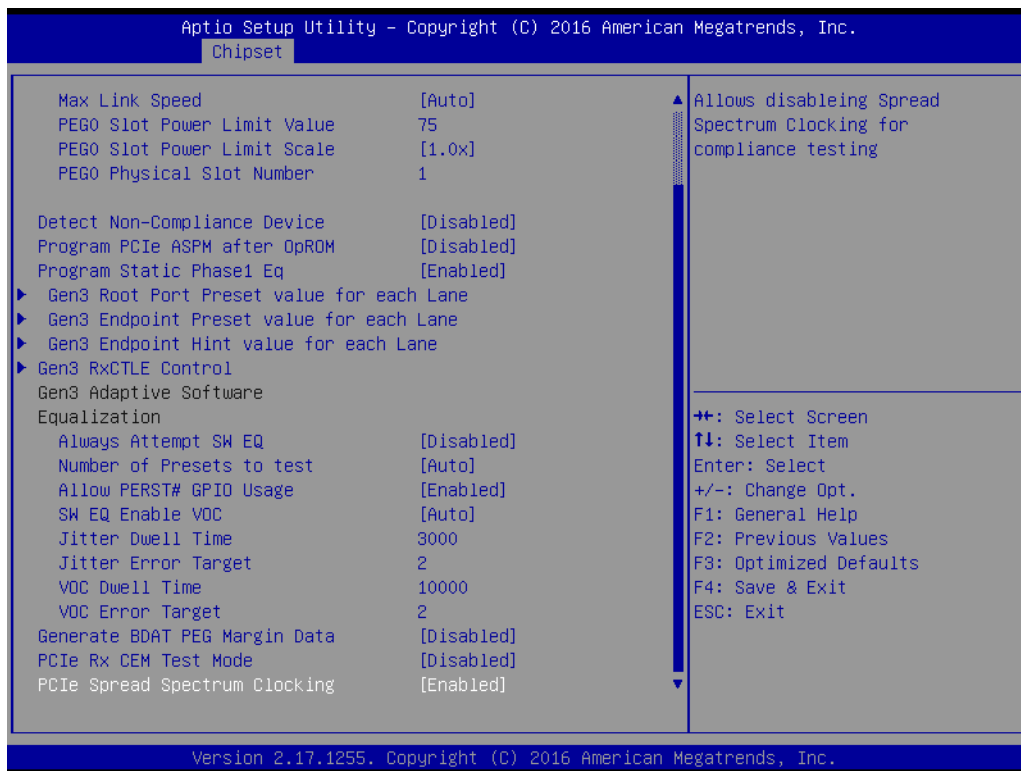


## Gen 3 RxCLTE Control



## ■ PEG Port Configuration





- **Enable Root Port [ Auto ]**
- **Max Link Speed [ Auto ]**
- **Detect Non-Compliance Device [ Disabled ]**  
Detect Non-Compliance PCI Express Device in PEG
- **Program PCIe ASPM after OpROM [ Disabled ]**  
Enabled: PCIe ASPM will be programmed after OpROM.  
Disabled: PCIe ASPM will be programmed before OpROM.
- **Program Static Phase1 Eq [ Enabled ]**
- **PEG Sampler Calibrate [ Disabled ]**

## Gen3 Root Port Preset value for each Lane

Gen3 Root Port Preset value for each Lane		Value for Lane 0
Lane 0	7	
Lane 1	7	
Lane 2	7	
Lane 3	7	
Lane 4	7	
Lane 5	7	
Lane 6	7	
Lane 7	7	
Lane 8	7	
Lane 9	7	
Lane 10	7	
Lane 11	7	
Lane 12	7	
Lane 13	7	
Lane 14	7	
Lane 15	7	

++: Select Screen  
 ↑: Select Item  
 Enter: Select  
 +/-: Change Opt.  
 F1: General Help  
 F2: Previous Values  
 F3: Optimized Defaults  
 F4: Save & Exit  
 ESC: Exit

Version 2.17.1255. Copyright (C) 2016 American Megatrends, Inc.

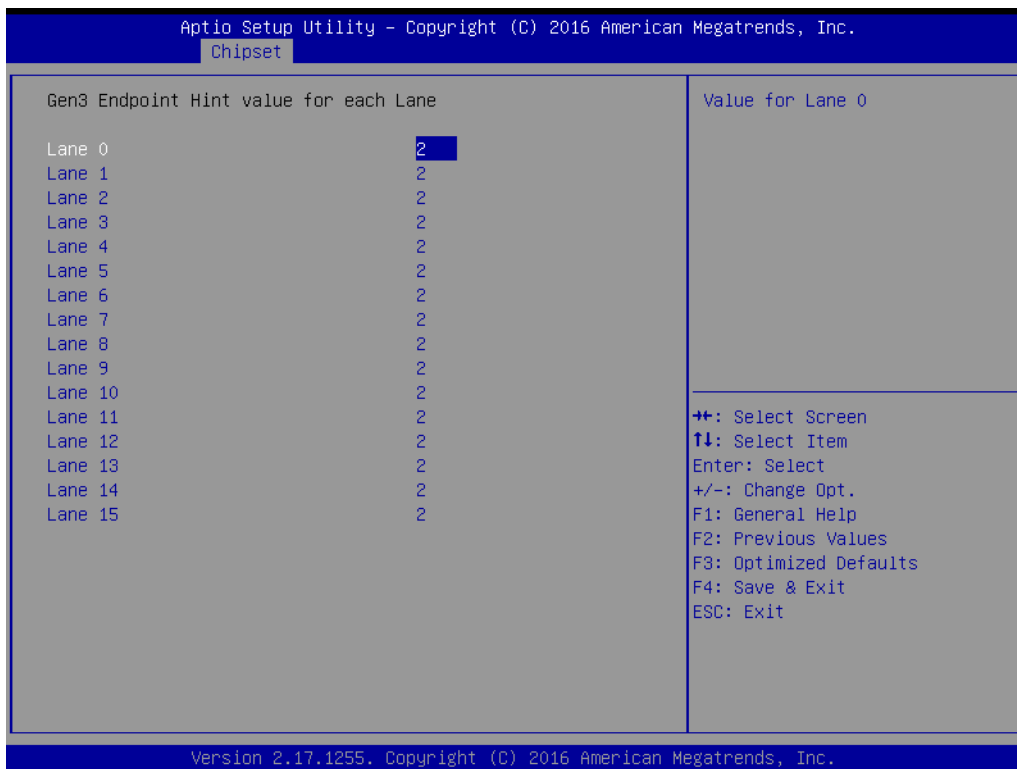
## Gen3 Endpoint Preset value for each Lane

Gen3 Endpoint Preset value for each Lane		Value for Lane 0
Lane 0	7	
Lane 1	7	
Lane 2	7	
Lane 3	7	
Lane 4	7	
Lane 5	7	
Lane 6	7	
Lane 7	7	
Lane 8	7	
Lane 9	7	
Lane 10	7	
Lane 11	7	
Lane 12	7	
Lane 13	7	
Lane 14	7	
Lane 15	7	

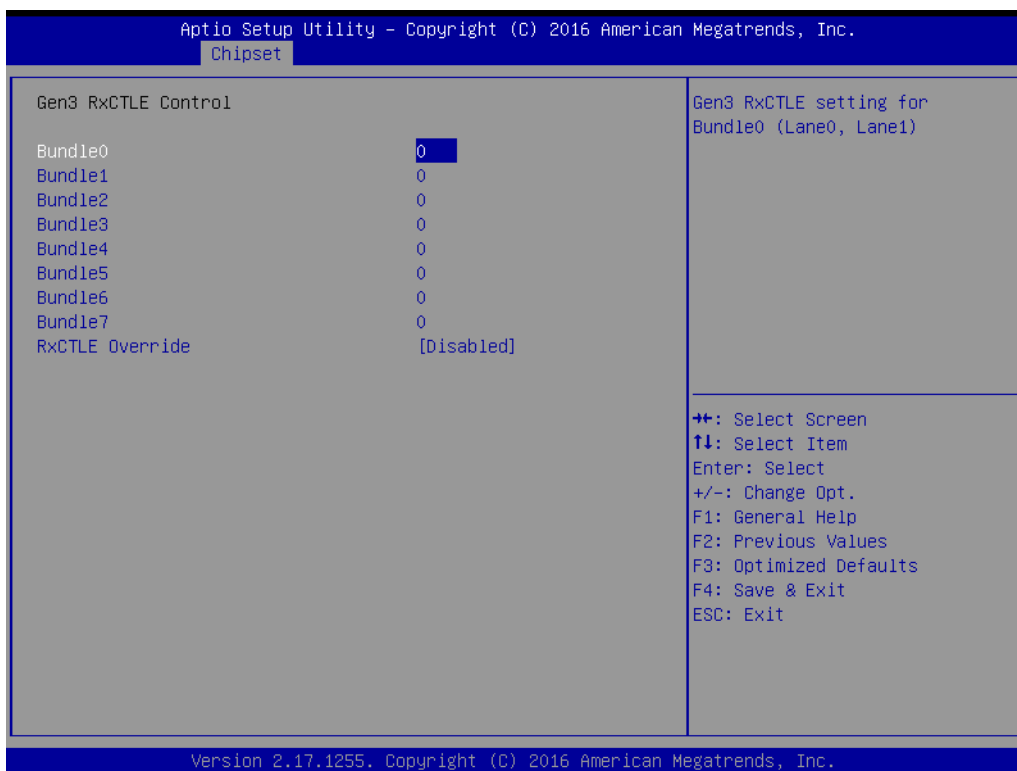
++: Select Screen  
 ↑: Select Item  
 Enter: Select  
 +/-: Change Opt.  
 F1: General Help  
 F2: Previous Values  
 F3: Optimized Defaults  
 F4: Save & Exit  
 ESC: Exit

Version 2.17.1255. Copyright (C) 2016 American Megatrends, Inc.

## Gen3 Endpoint Hint value for each Lane



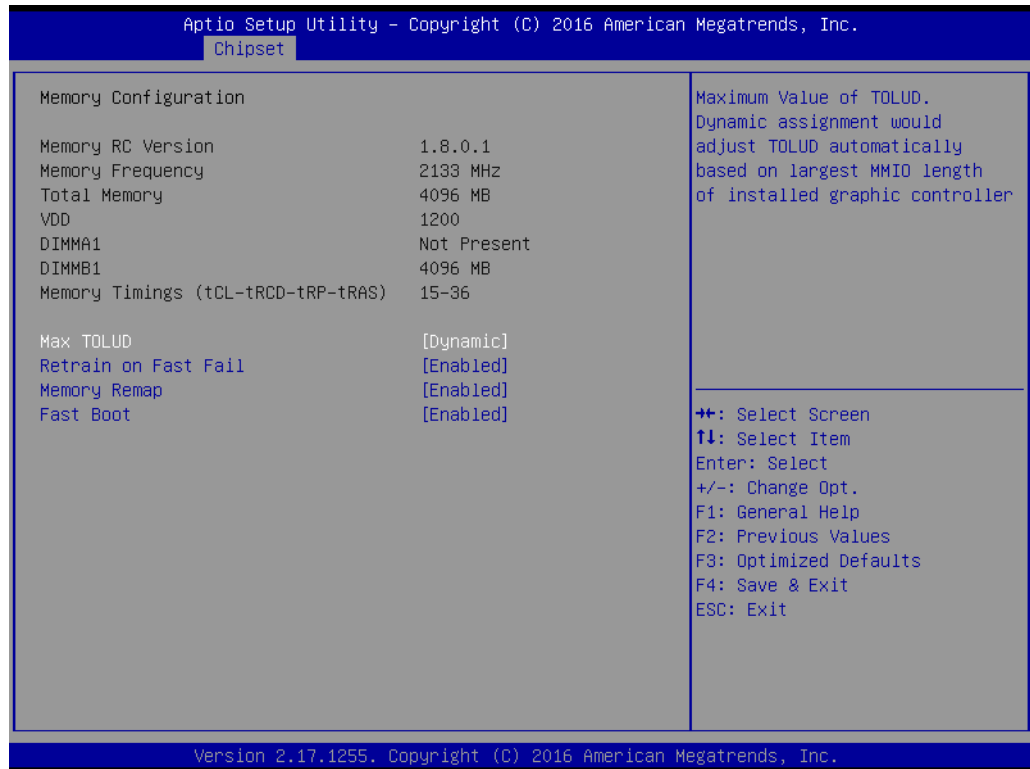
## Gen3 RxCTLE Control



- RxCTLE Override [ Disabled ]

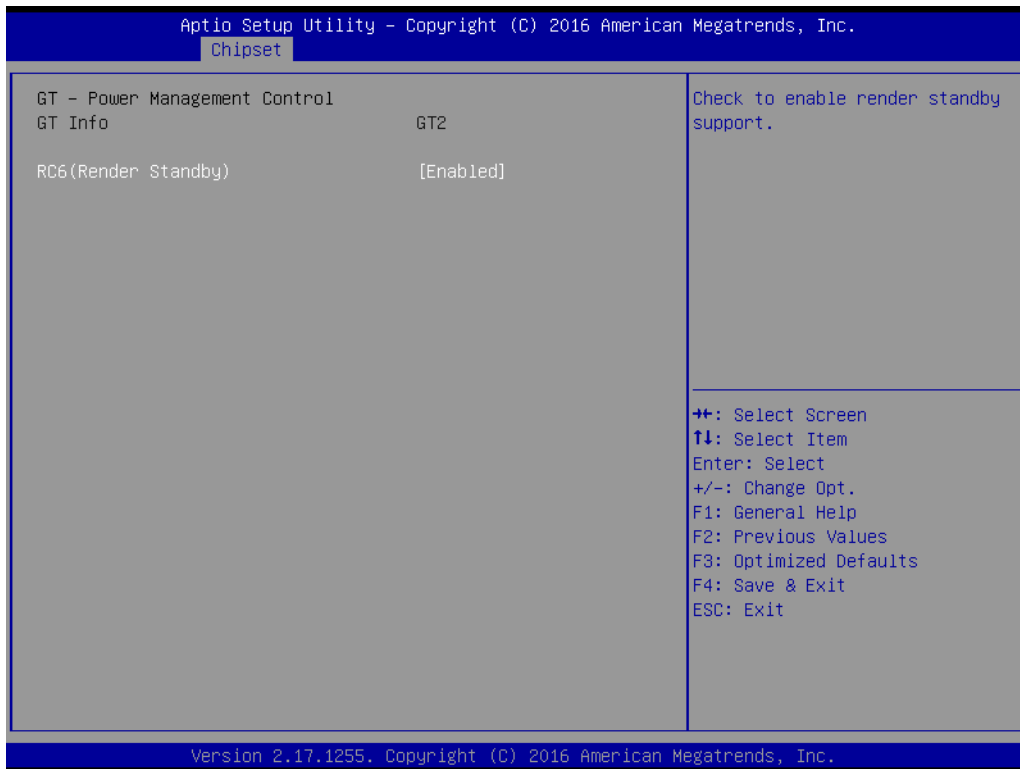
## Memory Configuration

The item shows you memory specification included RC version, Frequency, size and voltage information etc.



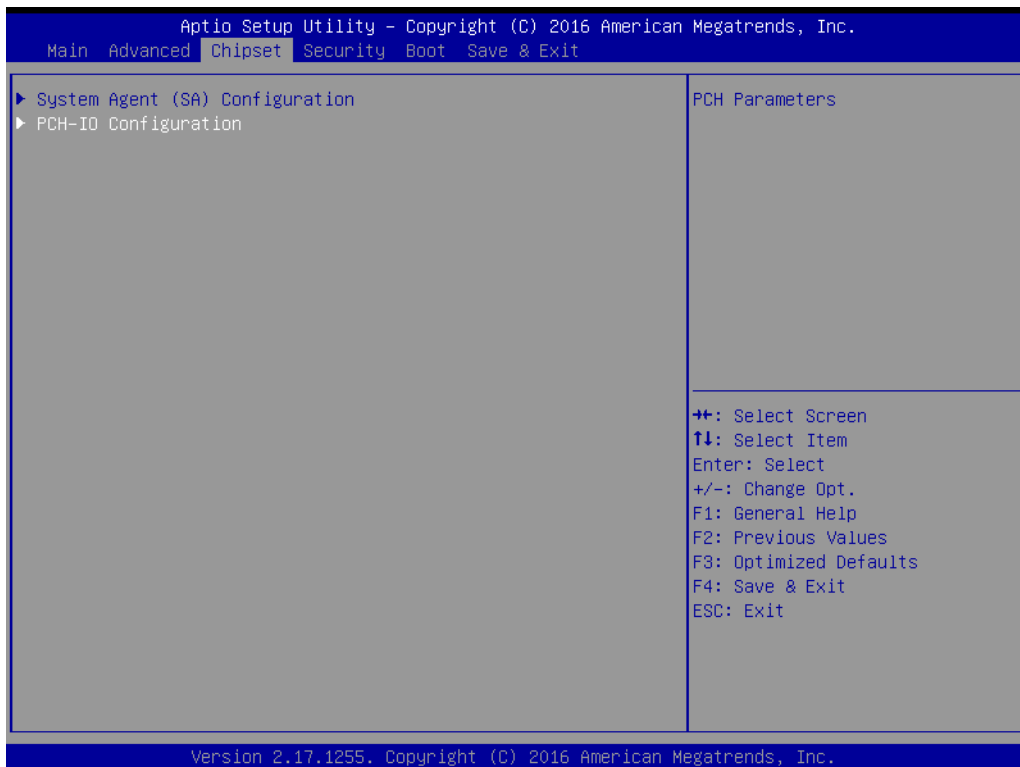
- **Max TOLUD [ Dynamic ]**  
Maximum Value of TOLUD.  
Dynamic assignment would adjust TOLUD automatically based on largest MMIO length of installed graphic controller.
- **Retrain on Fast Fail [ Enabled ]**
- **Memory Remap [ Enabled ]**
- **Fast Boot [ Enabled ]**

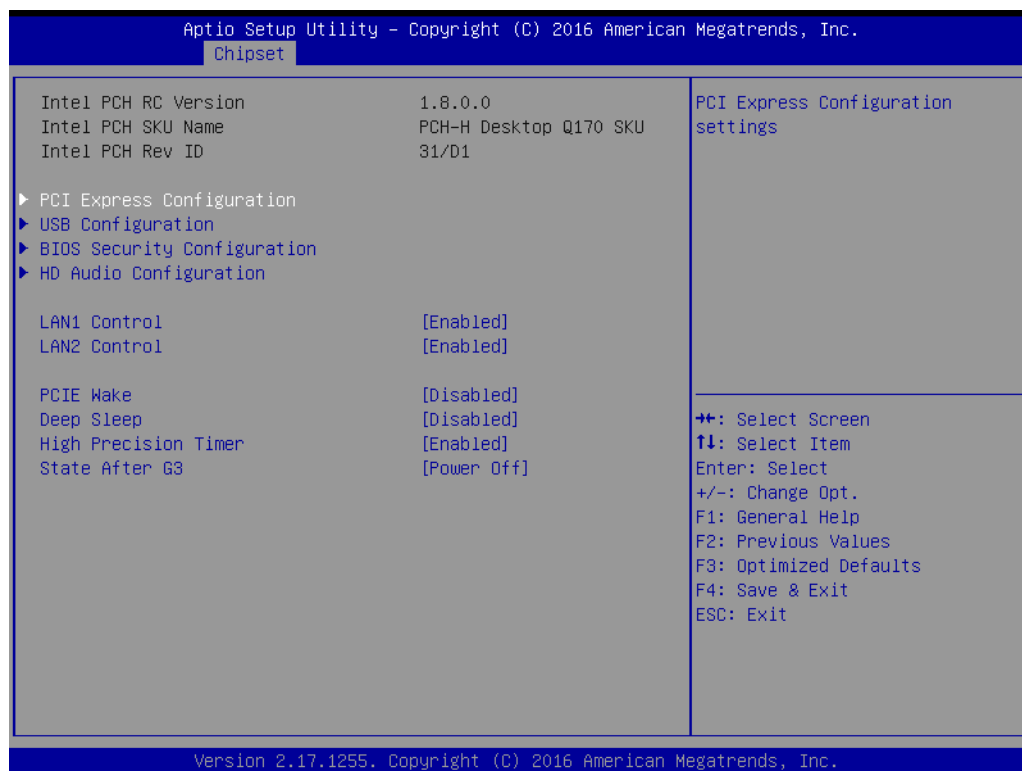
## GT- Power Management Control



- **RC6 (Render Standby) [ Enabled ]**  
Check to enable / disable render standby supported.

### 3.2.3.2 PCH-IO Configuration

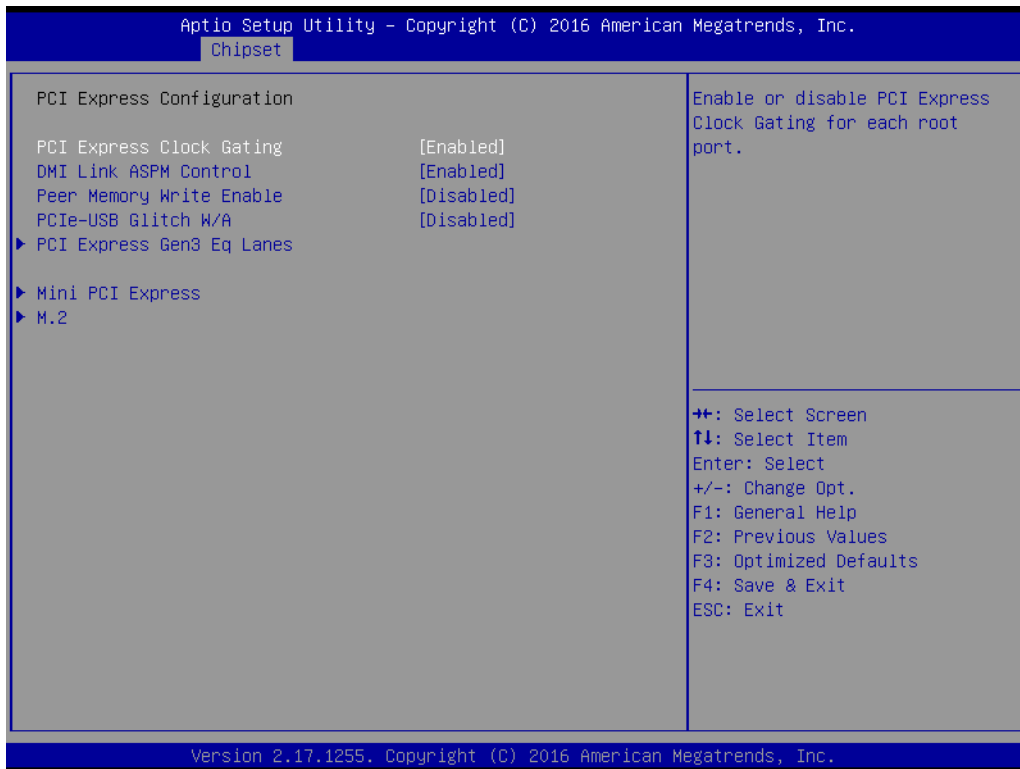




- **LAN1 Control [ Enabled ]**  
Enable or disable the LAN 1 controller.
- **LAN 2 controller [ Enabled ]**  
Enable or disable the LAN 2 controller.
- **PCIE Wake [ Disabled ]**  
Enable or disable PCIE Wake feature.
- **Deep Sleep [ Disabled ]**  
Enable or disable the Deep Sleep function.
- **High Precision Timer [ Enabled ]**
- **Start After G3 [ Power Off ]**

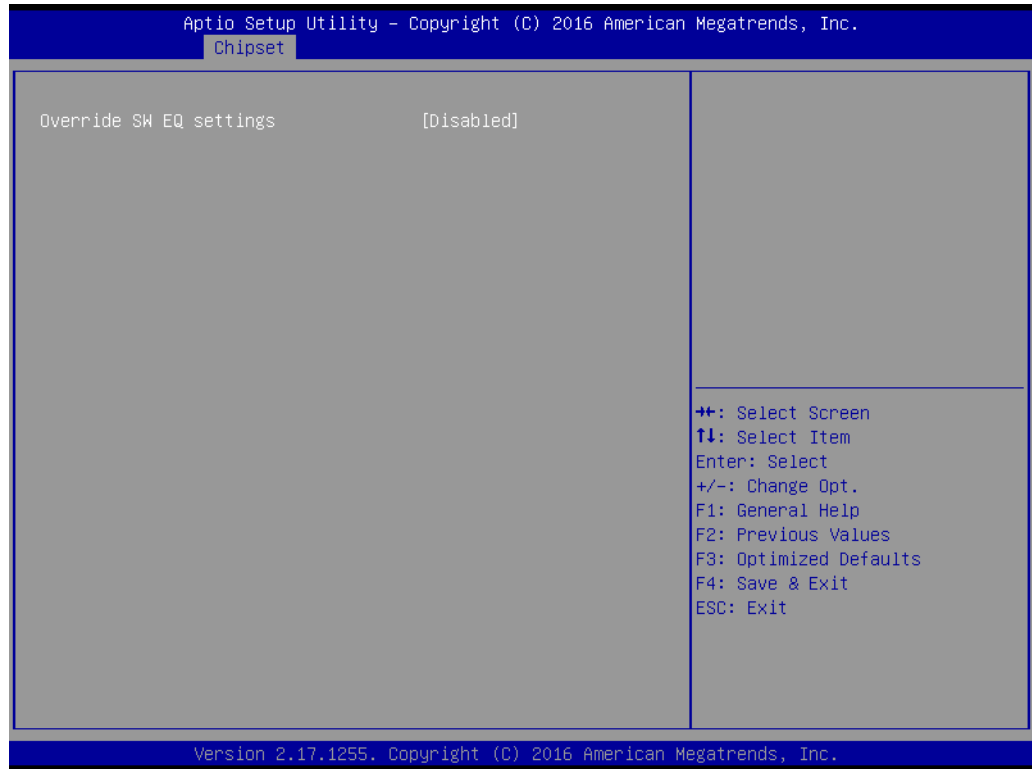


## PCI Express Configuration



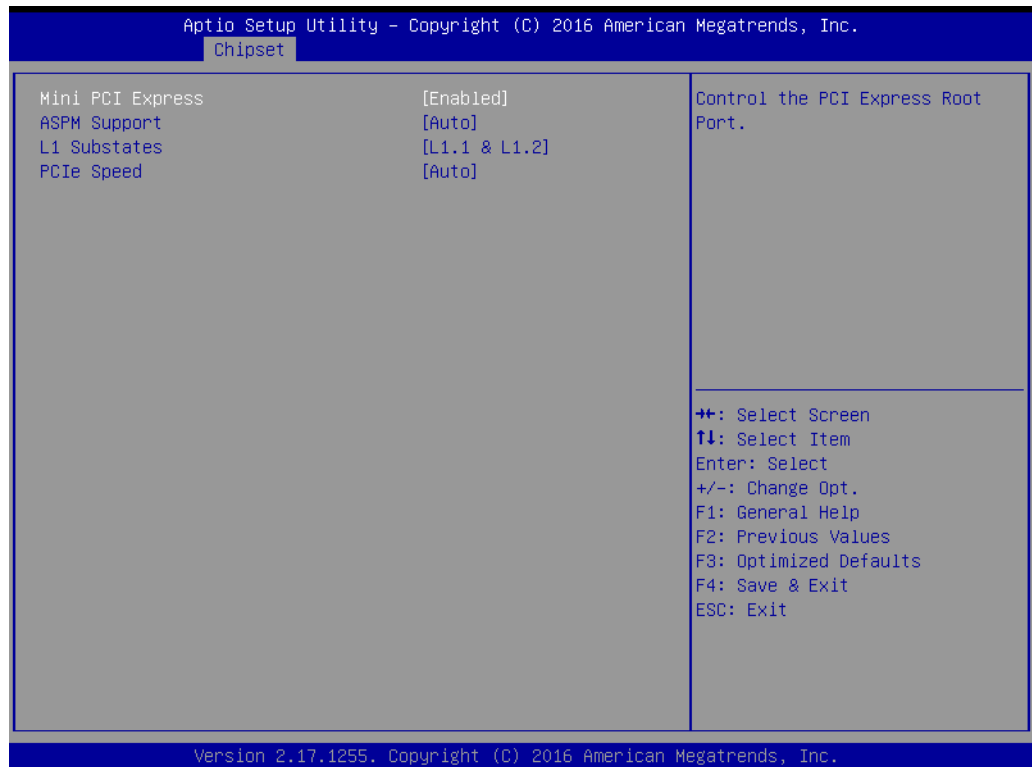
- **PCI Express Clock Gating [ Enabled ]**  
Enable or disable PCI Express Clock Gating for each root port.
- **DMI Link ASPM Control [ Enabled ]**  
Enable or disable the control of Active State Power Management on SA side of the DMI Link.
- **Peer Memory Write Enable [ Disabled ]**
- **PCIe-USB Glitch W/A [ Disabled ]**

## PCI Express G3 Eq Lanes



### ■ Override SW EQ settings [ Disabled ]

## Mini PCI Express



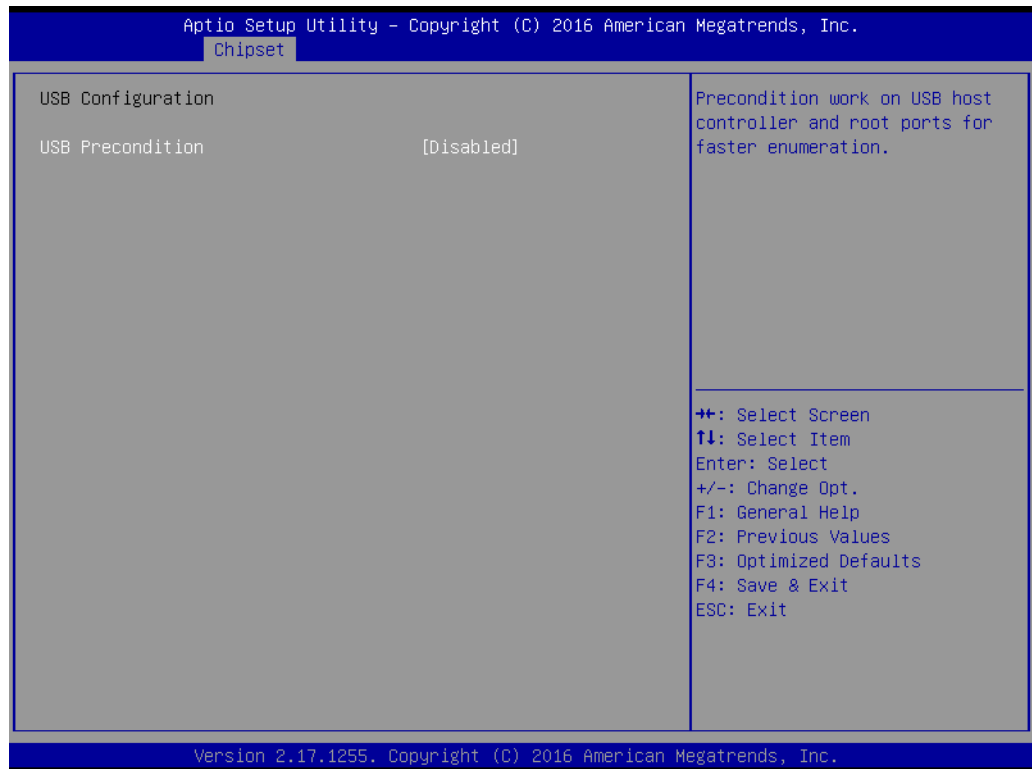
- **Mini PCI Express [ Enabled ]**  
Enable or disable PCI Express Root Port controller.
- **ASPM Support [ Auto ]**
- **L1 Substates [ L1.1 & L1.2 ]**
- **PCIe Speed [ Auto ]**

## M.2



- **M.2 [ Enabled ]**  
Enable or disable PCI Express Root Port controller.
- **ASPM Support [ Auto ]**
- **L1 Substates [ L1.1 & L1.2 ]**
- **PCIe Speed [ Auto ]**

## USB Configuration



### ■ USB Precondition [ Disabled ]

**Note!** All of USB 2.0 & 3.0 only supported from 1 XHCI controller.

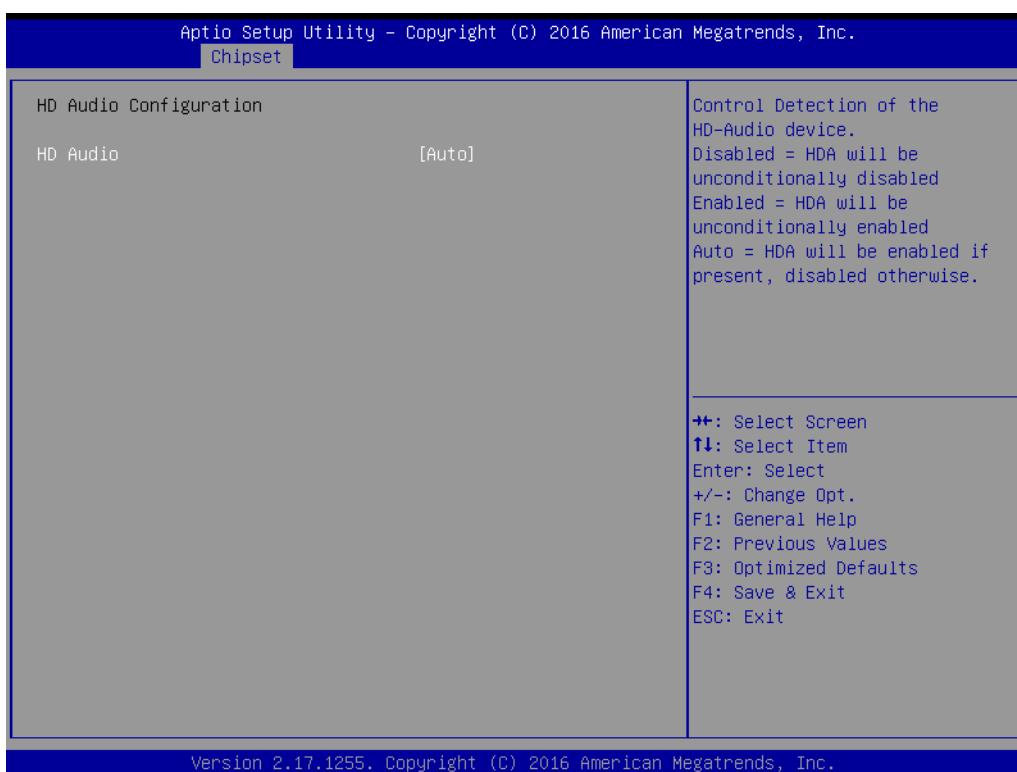


## BIOS Security Configuration



- **RTC Lock [ Enabled ]**  
Enable will lock bytes 38h-3Fh in the lower/upper 128 byte bank of RTC RAM.
- **BIOS Lock [ Enabled ]**

## HD Audio Configuration



■ **HD Audio [ Auto ]**

This item is to control detection of the HD-Audio device.

[ Disabled ] = HAD will be unconditionally disabled.

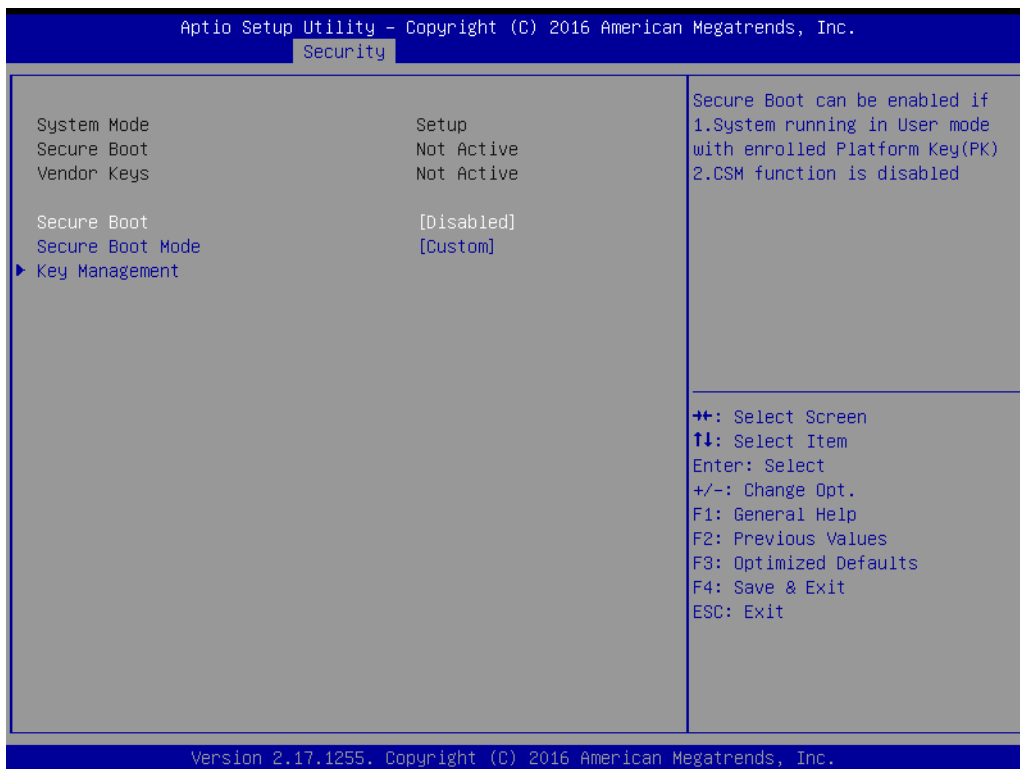
[ Enabled ] = HAD will be unconditionally enabled.

[ Auto ] = HAD will be enabled if present, disabled otherwise.

### 3.2.4 Security Setting



## Secure Boot menu



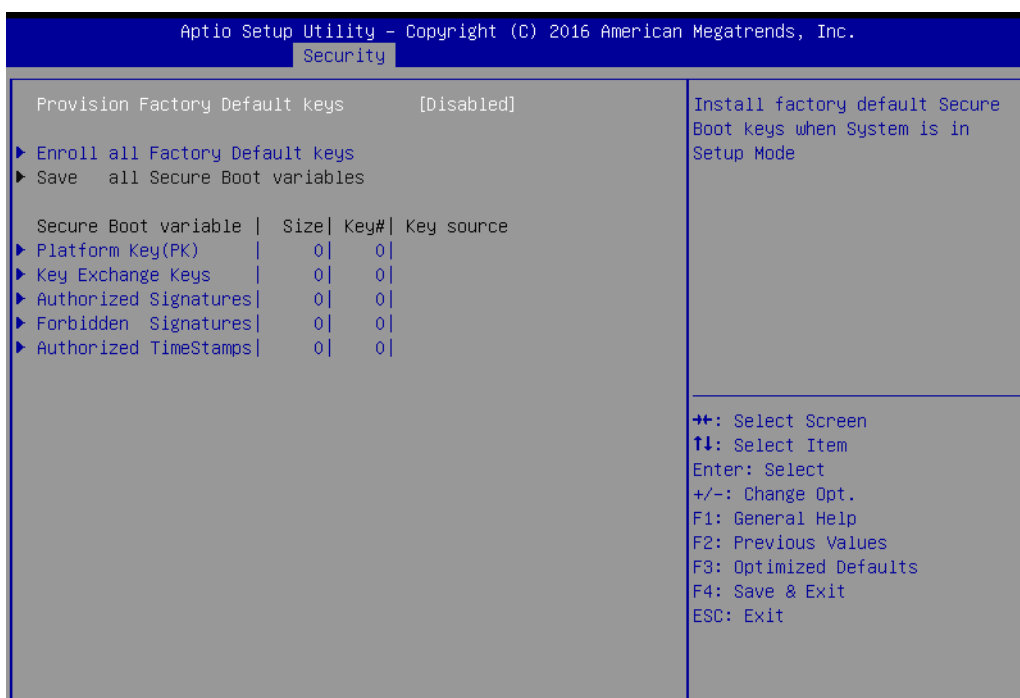
### ■ Secure Boot [ Disabled ]

Secure Boot can be enabled if the 2 conditions below are met:

1. System is running in user mode with enrolled Platform Key (PK)
2. CSM function is disabled

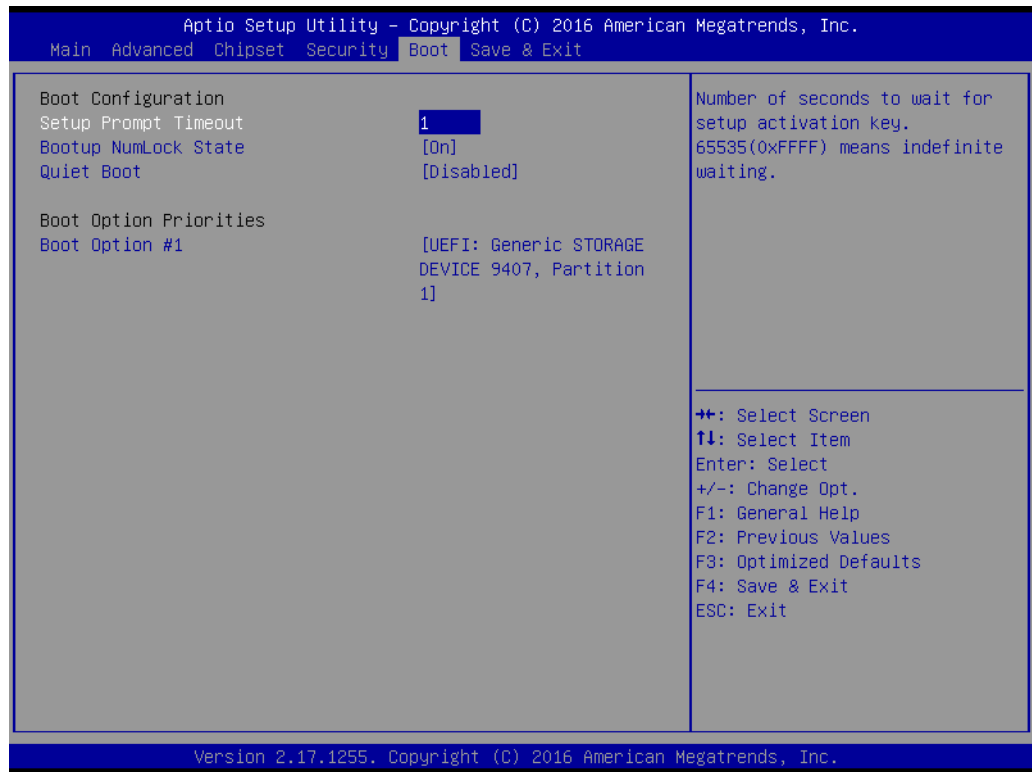
### ■ Secure Boot Mode [ Custom ]

## Key Management



- **Provision Factory Default Keys [ Disabled ]**  
Install factory default Secure Boot Kyes when system is in setup mode.

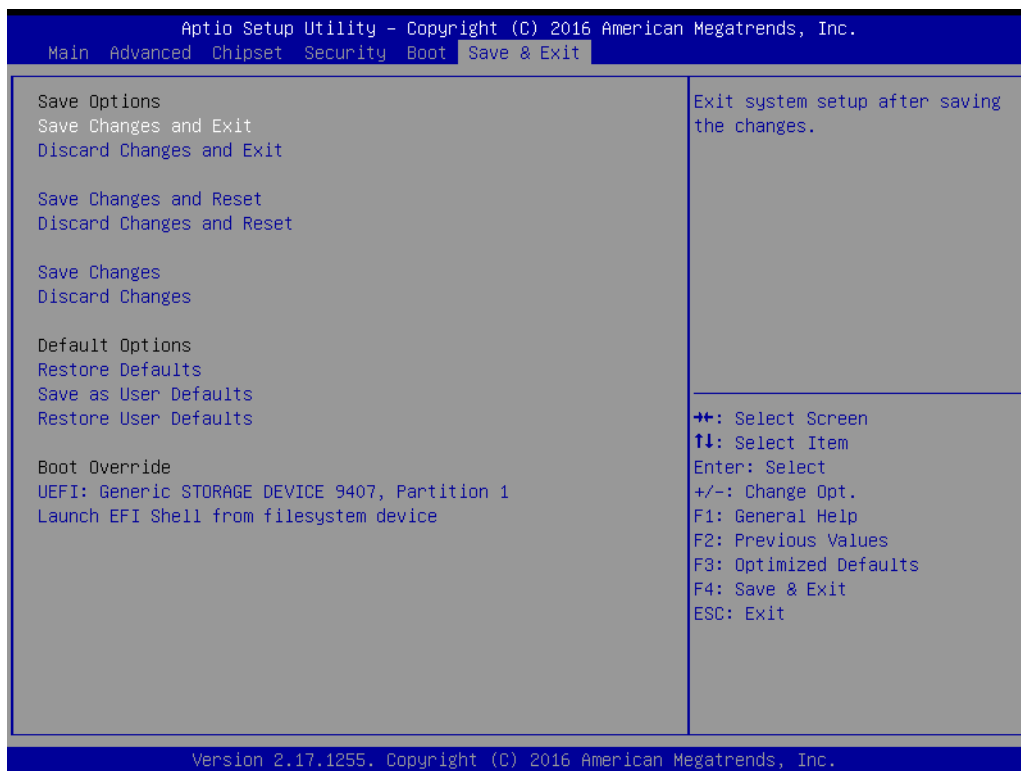
### 3.2.5 Boot Setting



- **Setup Prompt Timeout [ 1 ]**  
User the <+> and <-> keys to adjust the number of seconds to wait for setup activation key.
- **Bootup NumLock State [ On ]**  
On or Off power on state for the NumLock
- **Quiet Boot [ Disabled ]**  
If this option is set as disabled, the BIOS displays normal POST messages.  
If set as enabled, an OEM logo is shown instead of POST messages.
- **Boot Option Priorities**  
Choose boot priority from boot device



### 3.2.6 Save & Exit Configuration



#### ■ Save Changes and Exit

When users have completed system configuration, select this option to save changes, exit BIOS setup menu and reboot the computer to take effect all system configuration parameters.

1. Select Exit Saving Changes from the Exit menu and press <Enter>. The following message appears: Save Configuration Changes and Exit Now?
2. Select [OK] or [Cancel]

#### ■ Discard Changes and Exit

Select this option to quit Setup without making any permanent changes to the system configuration.

1. Select Exit Discarding Changes from the Exit menu and press <Enter>. The following message appears: Discard Changes and Exit Setup Now? [Ok] or [Cancel]
2. Select Ok to discard changes and exit. Discard Changes  
Select Discard Changes from the Exit menu and press <Enter>.

#### ■ Save Changes and Reset

When users have completed system configuration, select this option to save changes, exit BIOS setup menu and reboot the computer to take effect all system configuration parameters.

1. Select Exit Saving Changes from the Exit menu and press <Enter>. The following message appears: Save Configuration Changes and Exit Now? [Ok] or [Cancel]
2. Select [Ok] or [Cancel]

#### ■ Discard Changes and Reset

Select this option to quit Setup without making any permanent changes to the system configuration.

- 
1. Select Reset Discarding Changes from the Exit menu and press <Enter>. The following message appears: Discard Changes and Exit Setup Now? [Ok] or [Cancel]
  2. Select Ok to discard changes and reset. Discard Changes  
Select Discard Changes from the Exit menu and press <Enter>.

■ **Restore Default**

The BIOS automatically configures all setup items to optimal settings when users select this option. Defaults are designed for maximum system performance, but may not work best for all computer applications.

In particular, do not use the Defaults if the user's computer is experiencing system configuration problems. Select Restore Defaults from the Exit menu and press <Enter>.

■ **Save as User Default**

Save the all current settings as a user default.

■ **Restore User Default**

Restore all settings to user default values.

■ **Boot Override**

Shows the boot device types on the system.

# Chapter 4

Software Introduction  
& Service

## 4.1 Introduction

The mission of Advantech Embedded Software Services is to "Enhance quality of life with Advantech platforms and Microsoft® Windows® embedded technology." We enable Windows® Embedded software products on Advantech platforms to more effectively support the embedded computing community. Customers are freed from the hassle of dealing with multiple vendors (hardware suppliers, system integrators, embedded OS distributors) for projects. Our goal is to make Windows® Embedded Software solutions easily and widely available to the embedded computing community.

## 4.2 Value-Added Software Services

Software API: An interface that defines the ways by which an application program may request services from libraries and/or operating systems. Provides not only the underlying drivers required but also a rich set of user-friendly, intelligent and integrated interfaces, which speeds development, enhances security and offers add-on value for Advantech platforms. It plays the role of catalyst between developer and solution, and makes Advantech embedded platforms easier and simpler to adopt and operate with customer applications.

### 4.2.1 Software API

#### 4.2.1.1 Control

##### GPIO



General Purpose Input/Output is a flexible parallel interface that allows a variety of custom connections. It allows users to monitor the level of signal input or set the output status to switch on/off the device. Our API also provide Programmable GPIO, which allows developers to dynamically set the GPIO input or output status.

##### SMBus



SMBus is the System Management Bus defined by Intel Corporation in 1995. It is used in personal computers and servers for low-speed system management communications. The SMBus API allows a developer to interface a embedded system environment and transfer serial messages using the SMBus protocols, allowing multiple simultaneous device control.

#### 4.2.1.2 Display

##### Brightness Control



The Brightness Control API allows a developer to access embedded devices and easily control brightness.

##### Backlight



The Backlight API allows a developer to control the backlight (screen) on/off in embedded devices.

#### 4.2.1.3 Monitor

##### Watchdog



A watchdog timer (WDT) is a device that performs a specific operation after a certain period of time if something goes wrong and the system does not recover on its own. A watchdog timer can be programmed to perform a warm boot (restarting the system) after a certain number of seconds.

##### Hardware Monitor



The Hardware Monitor (HWM) API is a system health supervision API that inspects certain condition indexes, such as fan speed, temperature and voltage.

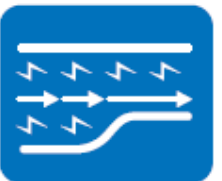
#### 4.2.1.4 Power Saving

##### CPU Speed



Makes use of Intel SpeedStep technology to save power consumption. The system will automatically adjust the CPU speed depending on the system loading.

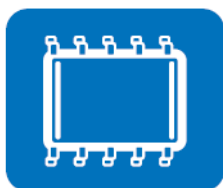
##### System Throttling



Refers to a series of methods for reducing power consumption in computers by lowering the clock frequency. This API allows the user to adjust the clock from 87.5% to 12.5%.

## 4.2.2 Software Utility

### BIOS Flash



The BIOS Flash utility allows customers to update the flash ROM BIOS version, or use it to back up current BIOS by copying it from the flash chip to a file on customers' disk. The BIOS Flash utility also provides a command line version and an API for fast implementation into customized applications.

### Embedded Security ID



The embedded application is the most important property of a system integrator. It contains valuable intellectual property, design knowledge and innovation, but it is easy to copy! Embedded Security ID utility provides reliable security functions for customers to secure their application data within the embedded BIOS.

### Monitoring



The Monitoring is a utility for customer to monitor the system health, like voltage, CPU and system temperature and fan speed. These items are important to a device, if the critical errors occur and are not solved immediately, permanent damage may be caused.

### eSOS



The eSOS is a small OS stored in BIOS ROM. It will boot up in case of a main OS crash. It will diagnose the hardware status, and then send an e-mail to the designated administrator. The eSOS also provide for remote connection via Telnet server and FTP server so the administrator can attempt to rescue the system. Note: This function requires BIOS customization.

# Chapter 5

Chipset Software  
Installation Utility

## 5.1 Before You Begin

To facilitate the installation of the enhanced display drivers and utility software, read the instructions in this chapter carefully. The drivers for the AIMB-275 are located on Advantech support website: <http://support.advantech.com/Support/>. The driver on the support website will guide and link you to the utilities and drivers under a Windows system. Updates are provided via Service Packs from Microsoft\*.

**Note!** *The driver files on the website are compressed. Do not attempt to install the drivers by copying the files manually. You must download the files and decompress them first. Also, please use the supplied SETUP program to install the drivers.*



Before you begin, it is important to note that most display drivers need to have the relevant software application already installed in the system prior to installing the enhanced display drivers. In addition, many of the installation procedures assume that you are familiar with both the relevant software applications and operating system commands. Review the relevant operating system commands and the pertinent sections of your application software's user manual before performing the installation.

## 5.2 Introduction

The Intel® Chipset Software Installation (CSI) utility installs the Windows INF files that outline to the operating system how the chipset components will be configured. This is needed for the proper functioning of the following features:

- Core PCI PnP services
- Serial ATA interface support
- USB support
- Identification of Intel® chipset components in the Device Manager

**Note!** *This utility is used for the following versions of Windows, and it has to be installed **before** installing all the other drivers:*



- Windows 7 (32-bit)
- Windows 7 (64-bit)
- Windows 8 (64-bit)
- Windows 10 (64 bit)







# Chapter 6

USB Setup

## 6.1 Introduction

From 6th Gen Intel Platform, it only has XHCI USB controller for all of USB 2.0 / 3.0 ports. So, when your operation system is Win 7, you need to install USB 3.0 driver manually first. Before you install USB 3.0 driver, all of USB ports can not work properly. So, Please make sure you connect PS/2 keyboard mouse to install the driver first.

For Win8 OS, the inbox driver enables the USB controller to work automatically. You still can download and update the WIN8.1 USB 3.0 driver from the website.

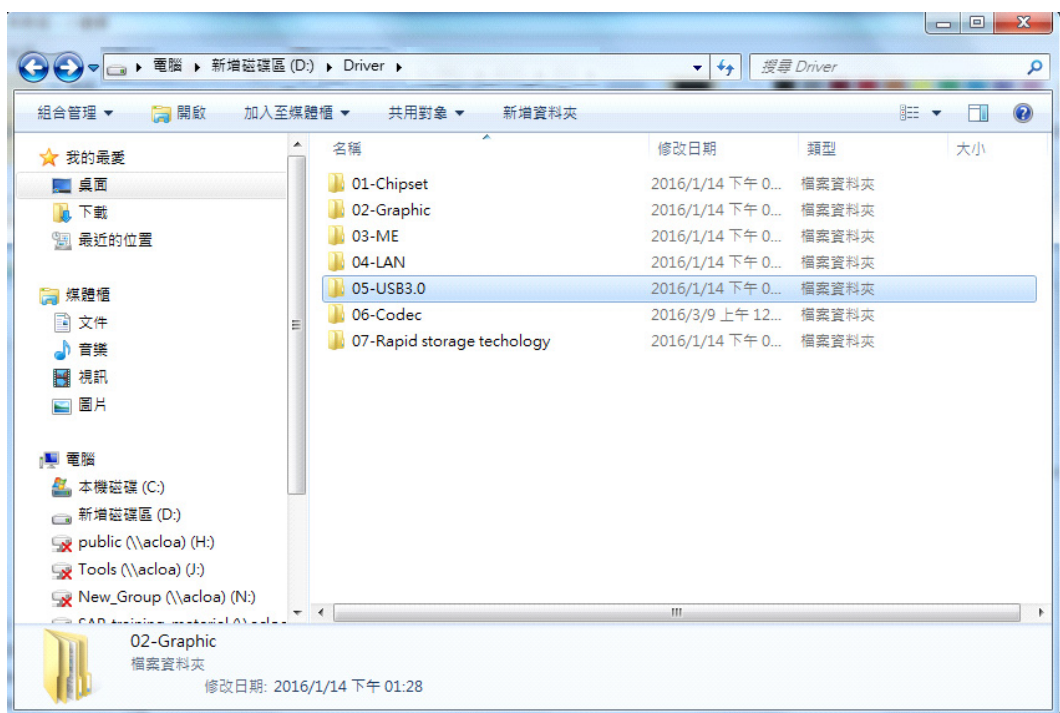
<http://support.advantech.com/Support/>

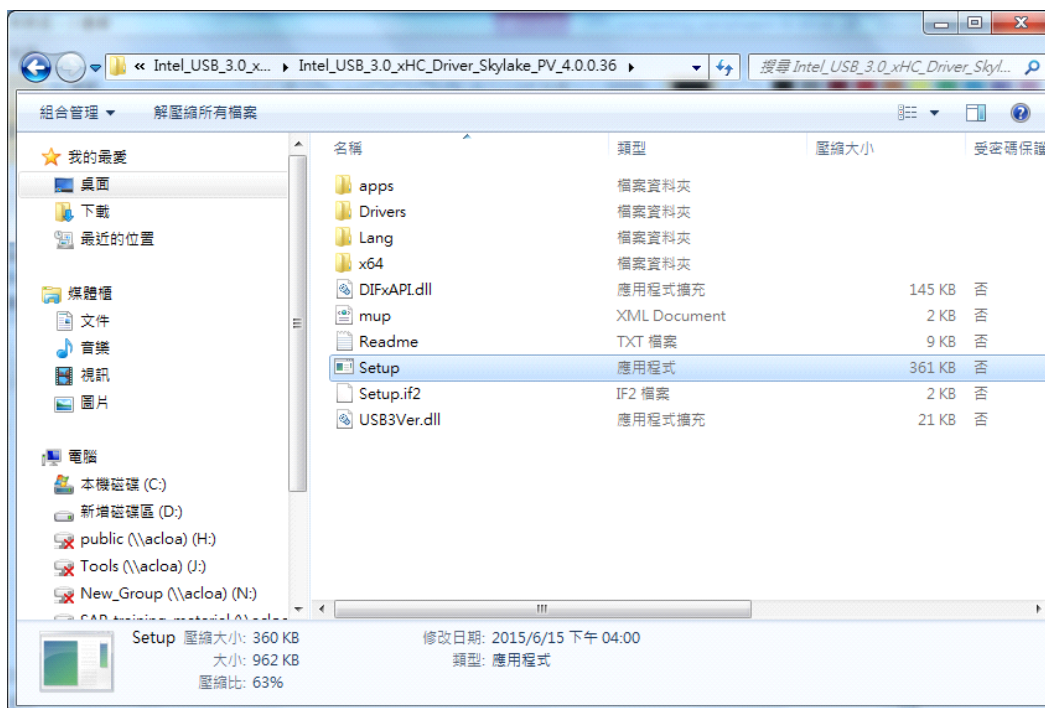
## 6.2 Win 7 / 8 USB 3.0 Driver installation

**Note!** *If your operation system is Win7, please make sure you insert PS/2 keyboard mouse to install the driver first.*



Download USB 3.0 driver from website to your computer. Click “USB 3.0” folder and chose WIN7 or WIN8 for the driver installation.







# Chapter 7

## VGA Setup

## 7.1 Introduction

The 6th Gen Intel Core i processors are embedded with an integrated graphics controller. You need to install the VGA driver to enable the function.

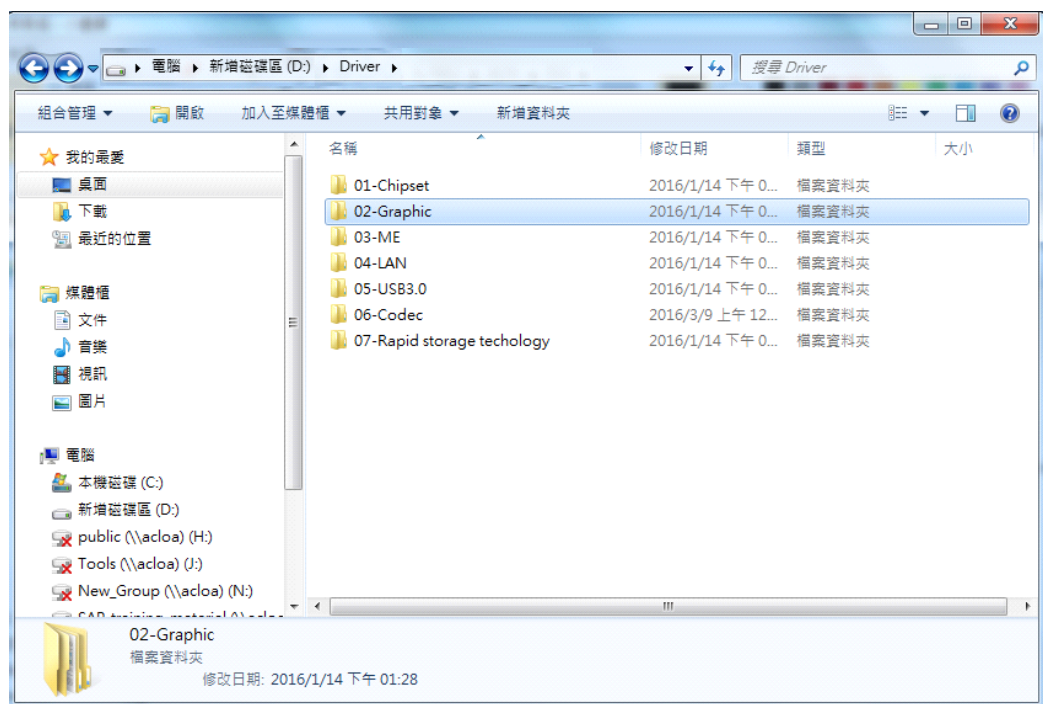
Optimized integrated graphic solution: With Intel Graphics Flexible, it supports versatile display options and 32-bit 3D graphics engine. Dual independent display, enhanced display modes for widescreen flat panels for extend, twin, and clone dual display mode, and optimized 3D support deliver an intensive and realistic visual experience.

## 7.2 Windows 7/8/10 VGA Driver Installation

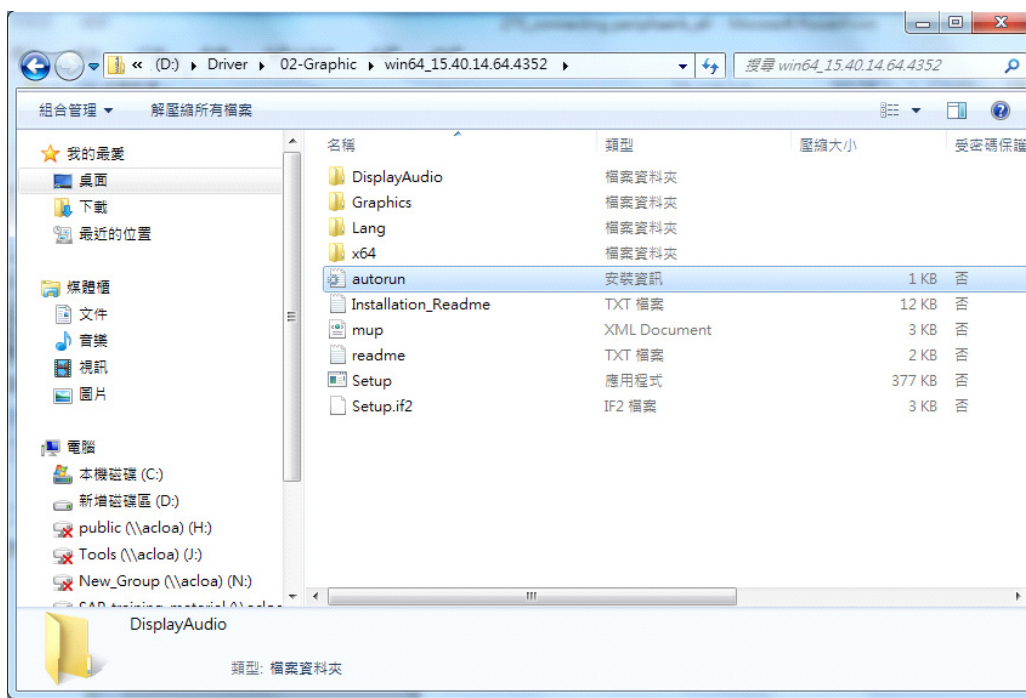
**Note!** Before installing this driver, make sure the CSI utility has been installed in your system. See Chapter 5 for information on installing the CSI utility.



Download the driver from website on your computer. Navigate to the "Graphics" folder and click "setup.exe" to complete the installation of the drivers for Windows 7, Windows 8 and Windows 10.









# Chapter 8

## LAN Configuration

---

## 8.1 Introduction

The AIMB-275 has dual Gigabit Ethernet LANs via dedicated PCI Express x1 lanes (Intel I219LM (LAN1) and I211AT (LAN2)) that offer bandwidth of up to 500 MB/sec, eliminating the bottleneck of network data flow and incorporating Gigabit Ethernet at 1000 Mbps.

## 8.2 Features

- Integrated 10/100/1000 Mbps transceiver
- 10/100/1000 Mbps triple-speed MAC
- High-speed RISC core with 24-KB cache
- On-chip voltage regulation
- Wake-on-LAN (WOL) support
- PCI Express X1 host interface

## 8.3 Installation

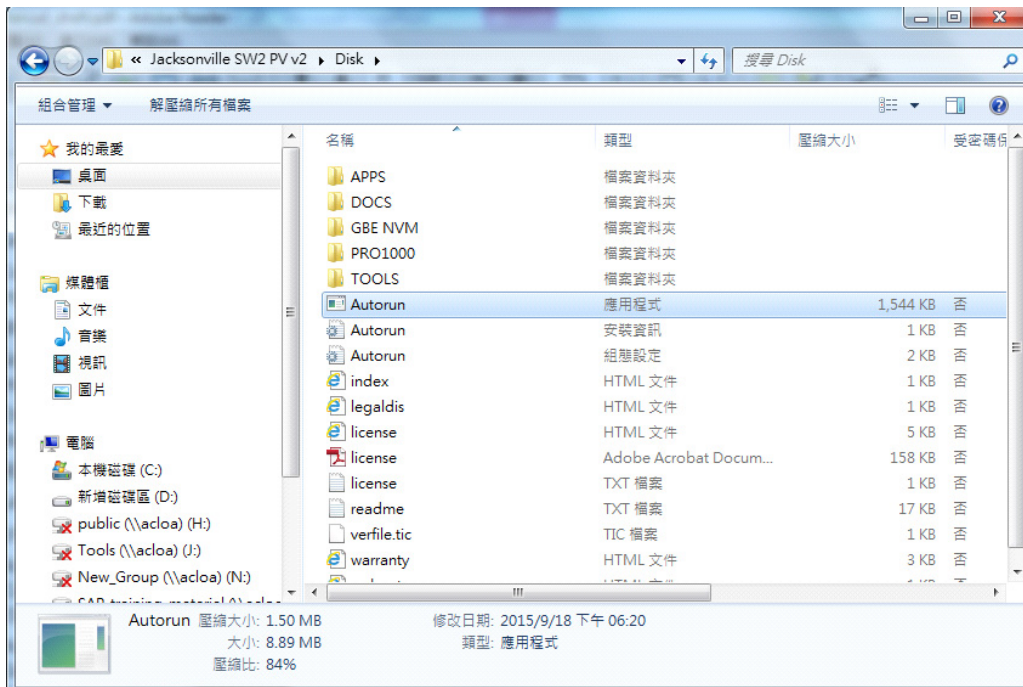
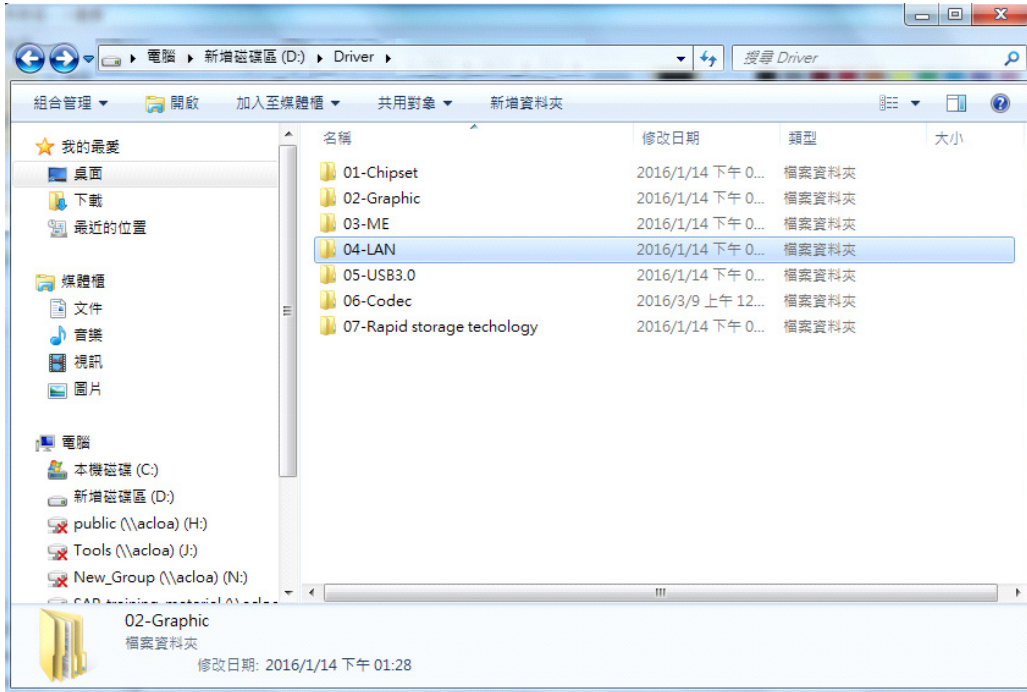
**Note!** *Before installing the LAN drivers, make sure the CSI utility has been installed on your system. See Chapter 5 for information on installing the CSI utility.*



The AIMB-275's Intel I219LM (LAN1) and I211AT (LAN2) Gigabit integrated controllers support all major network operating systems. However, the installation procedure varies from system to system. Please find and use the section that provides the driver setup procedure for the operating system you are using.

## 8.4 Windows® 7/8/10 Driver Setup (Intel I219LM / I211AT)

Download the driver from support website on your computer and decompressed the file. Select the "Autorun" then navigate to the directory for your OS.

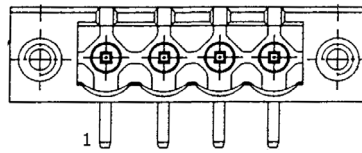




# Appendix **A**

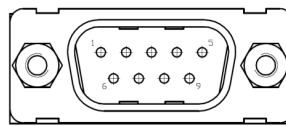
I/O Pin Assignments

## A.1 DC input Phoenix Connector (DCIN1)



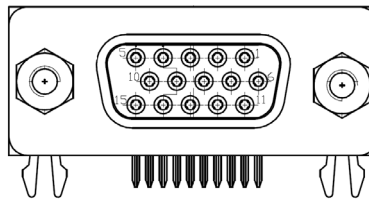
Pin	Signal	Pin	Signal
1	GND	2	Vcc(12~24v)
3	Vcc(12~24v)	4	GND

## A.2 COM Port (COM1)



Pin	Signal	Pin	Signal
1	DCD#	6	DSR#
2	RXD	7	RTS#
3	TXD	8	CTS#
4	DTR#	9	RI#
5	GND		

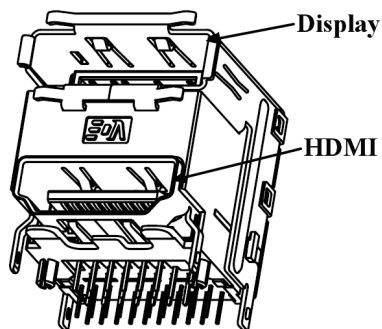
## A.3 Video Graphics Array Connector (VGA1)



Pin	Signal	Pin	Signal
1	RED	2	GREEN
3	BLUE	4	x
5	GND	6	GND
7	GND	8	GND
9	VCC_VGA	10	GND
11	x	12	SDA
13	HSYNC	14	VSYNC
15	SCL		

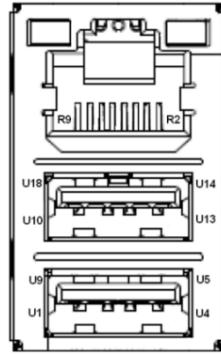


## A.4 DisplayPort + High Definition Multimedia Interface (DP1+HDMI1)



Pin	Signal	Pin	Signal
1	HDMI1_Z_D2+	A1	DP1_0+
2	GND	A2	GND
3	HDMI1_Z_D2-	A3	DP1_0-
4	HDMI1_Z_D1+	A4	DP1_1+
5	GND	A5	GND
6	HDMI1_Z_D1-	A6	DP1_1-
7	HDMI1_Z_D0+	A7	DP1_2+
8	GND	A8	GND
9	HDMI1_Z_D0-	A9	DP1_2-
10	HDMI1_Z_CLK+	A10	DP1_3+
11	GND	A11	GND
12	HDMI1_Z_CLK-	A12	DP1_3-
13	x	A13	DP1_AUX_EN#
14	x	A14	GND
15	HDMI1_SCL	A15	DP1_AUX+
16	HDMI1_SDA	A16	GND
17	GND	A17	DP1_AUX-
18	+V5_HDMI	A18	DP1_HPD
19	HDMI1_HPD	A19	GND
		A20	+V3.3_DP1

## A.5 RJ45+USB 3.0 Stack Connector (LAN1\_USB12) RJ45+USB 3.0 Stack Connector (LAN2\_USB34)



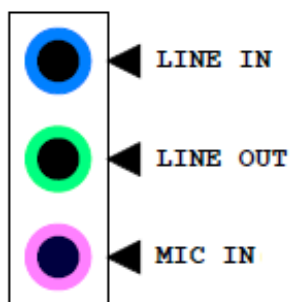
### RJ45

Pin	Signal	Pin	Signal
R2	MDI_0+	R6	MDI_2+
R3	MDI_0-	R7	MDI_2-
R4	MDI_1+	R8	MDI_3+
R5	MDI_1-	R9	MDI_3-

### USB

Pin	Signal	Pin	Signal
U1	+5V	U10	+5V
U2	D0-	U11	D1-
U3	D0+	U12	D1+
U4	GND	U13	GND
U5	RX0-	U14	RX1-
U6	RX0+	U15	RX1+
U7	GND	U16	GND
U8	TX0-	U17	TX1-
U9	TX0+	U18	TX1+

## A.6 HD Analog Audio Interface (AUDIO1)



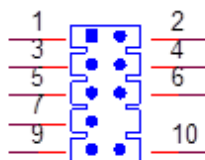
Pin	Signal
1	MIC IN
2	LINE OUT
3	LINE IN

## A.7 Audio Amplifier Output Connector (AMP1)



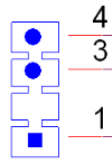
Pin	Signal
1	R+
2	R-
3	L-
4	L+

## A.8 Front HD Analog Audio Interface (FPAUD1)



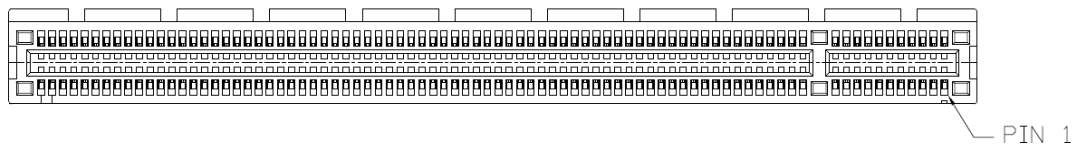
Pin	Signal	Pin	Signal
1	MIC IN L	2	GND
3	MIC IN R	4	FPAUD_DETECT#
5	LINE OUT R	6	SENSE R1
7	SENSE	8	KEY
9	LINE OUT L	10	SENSE R2

## A.9 HD Digital Audio Interface (SPDIF1)



Pin	Signal
1	+5V
3	SPDIF OUT
4	GND

## A.10 PCI-E x16 Slot (PCIEX16\_1)

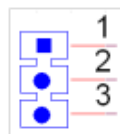


Pin	Signal	Pin	Signal
B1	+12V	A1	PRSNT1#
B2	+12V	A2	+12V
B3	+12V	A3	+12V
B4	GND	A4	GND
B5	SMB_CLK	A5	Reserved
B6	SMB_DATA	A6	Reserved
B7	GND	A7	Reserved
B8	+3.3V	A8	Reserved
B9	Reserved	A9	+3.3V
B10	+3.3VAUX	A10	+3.3V
B11	WAKE#	A11	PWRGD
B12	Reserved	A12	GND
B13	GND	A13	REFCLK+
B14	TX0+	A14	REFCLK-
B15	TX0-	A15	GND
B16	GND	A16	RX0+
B17	Reserved	A17	RX0-
B18	DETECT#	A18	GND
B19	TX1+	A19	CONFIG1
B20	TX1-	A20	GND

B21	GND	A21	RX1+
B22	GND	A22	RX1-
B23	TX2+	A23	GND
B24	TX2-	A24	GND
B25	GND	A25	RX2+
B26	GND	A26	RX2-
B27	TX3+	A27	GND
B28	TX3-	A28	GND
B29	GND	A29	RX3+
B30	Reserved	A30	RX3-
B31	Reserved	A31	GND
B32	GND	A32	CONFIG2
B33	TX4+	A33	Reserved
B34	TX4-	A34	GND
B35	GND	A35	RX4+
B36	GND	A36	RX4-
B37	TX5+	A37	GND
B38	TX5-	A38	GND
B39	GND	A39	RX5+
B40	GND	A40	RX5-
B41	TX6+	A41	GND
B42	TX6-	A42	GND
B43	GND	A43	RX6+
B44	GND	A44	RX6-
B45	TX7+	A45	GND
B46	TX7-	A46	GND
B47	GND	A47	RX7+
B48	Reserved	A48	RX7-
B49	GND	A49	GND
B50	TX8+	A50	Reserved
B51	TX8-	A51	GND
B52	GND	A52	RX8+
B53	GND	A53	RX8-
B54	TX9+	A54	GND
B55	TX9-	A55	GND
B56	GND	A56	RX9+
B57	GND	A57	RX9-
B58	TX10+	A58	GND

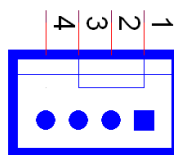
B59	TX10-	A59	GND
B60	GND	A60	RX10+
B61	GND	A61	RX10-
B62	TX11+	A62	GND
B63	TX11-	A63	GND
B64	GND	A64	RX11+
B65	GND	A65	RX11-
B66	TX12+	A66	GND
B67	TX12-	A67	GND
B68	GND	A68	RX12+
B69	GND	A69	RX12-
B70	TX13+	A70	GND
B71	TX13-	A71	GND
B72	GND	A72	RX13+
B73	GND	A73	RX13-
B74	TX14+	A74	GND
B75	TX14-	A75	GND
B76	GND	A76	RX14+
B77	GND	A77	RX14-
B78	TX15+	A78	GND
B79	TX15-	A79	GND
B80	GND	A80	RX15+
B81	Reserved	A81	RX15-
B82	Reserved	A82	GND

## A.11 SMBUS Programming INFINEON for +Vcore Controller (JSMB1)



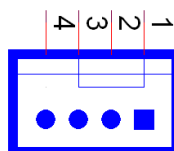
Pin	Signal
1	INF_SMBCLK
2	INF_SMBDATA
3	GND

## A.12 CPU FAN Power Connector (CPUFAN1)



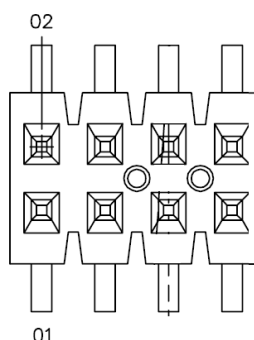
Pin	Signal
1	GND
2	+12V
3	DETECT
4	PWM IN

## A.13 SYSTEM FAN Power Connector (SYSFAN2)



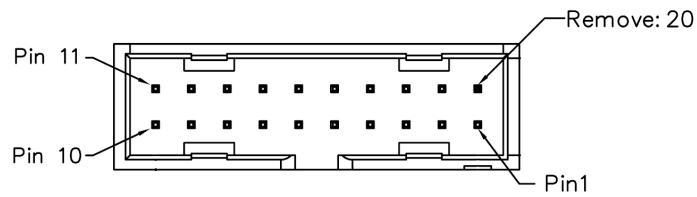
Pin	Signal
1	GND
2	+12V
3	DETECT
4	PWM IN

## A.14 SPI Programming Pin Header (SPI\_CN1)



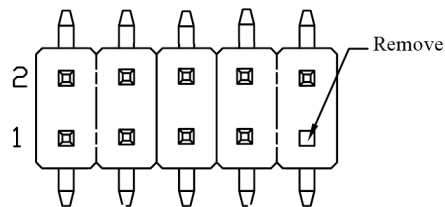
Pin	Signal	Pin	Signal
1	CS#	2	+3.3V
3	MISO	4	X
5	X	6	SCK
7	GND	8	MOSI

## A.15 USB 3.0 Connector (USB56)



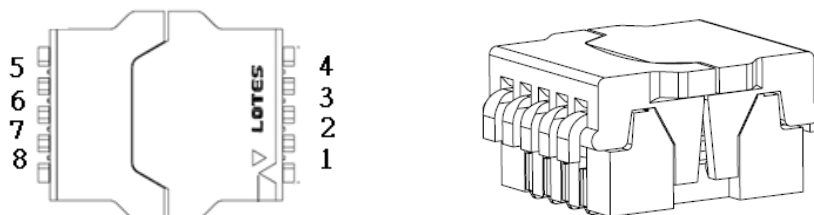
Pin	Signal	Pin	Signal
1	+5V	2	USB3X5_Z_RX-
3	USB3X5_Z_RX+	4	GND
5	USB3X5_Z_TX-	6	USB3X5_Z_TX+
7	GND	8	USB_D5-
9	USB_D5+	10	x
11	USB_D6+	12	USB_D6-
13	GND	14	USB3X6_Z_TX+
15	USB3X6_Z_TX-	16	GND
17	USB3X6_Z_RX+	18	USB3X6_Z_RX-
19	+5V	20	x

## A.16 USB 2.0 Connector (USB78/ USB910)



Pin	Signal	Pin	Signal
1	+5V	2	+5V
3	D-	4	D-
5	D+	6	D+
7	GND	8	GND
9	Key	10	x

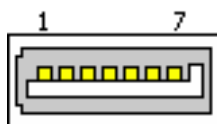
## A.17 SPI BIOS Flash Socket (SPI1)





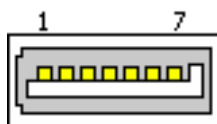
Pin	Signal	Pin	Signal
1	CS#	5	MOSI
2	MISO	6	SCK
3	WP# / IO2	7	HOLD# / IO3
4	GND	8	+3.3V

## A.18 SATA Signal Connector (SATA1/ 2)



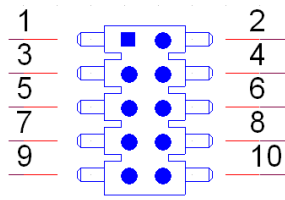
Pin	Signal
1	GND
2	TX+
3	TX-
4	GND
5	RX-
6	RX+
7	GND

## A.19 SATA/SATA-DOM Signal Connector (SATA3)



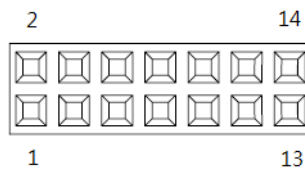
Pin	Signal
1	GND/SATA DOM power
2	TX+
3	TX-
4	GND
5	RX-
6	RX+
7	GND

## A.20 General Purpose I/O Pin Header (GPIO1)



Pin	Signal	Pin	Signal
1	GPIO0	2	GPIO4
3	GPIO1	4	GPIO5
5	GPIO2	6	GPIO6
7	GPIO3	8	GPIO7
9	+5Vsb	10	GND

## A.21 Low Pin Count Header (LPC1)



Pin	Signal	Pin	Signal
1	CLK_33M	2	AD1
3	RESET#	4	AD0
5	FRAME#	6	+3.3V
7	AD3	8	GND
9	AD2	10	SMB_CLK
11	SERIRQ	12	SMB_DATA
13	+5VSB	14	+5V

## A.22 PS/2 Keyboard and Mouse Connector (KBMS1)



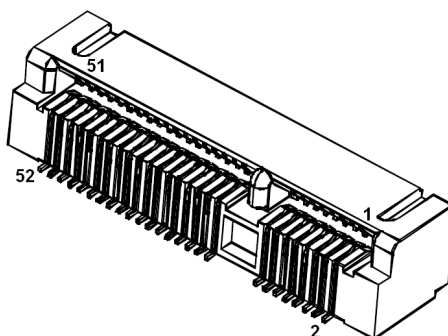
Pin	Signal	Pin	Signal
1	KB CLK	2	KB DATA
3	MS CLK	4	GND
5	+5V	6	MS DATA

## A.23 ATX Power supply (5VSB) connector (ATX\_5VSB1)



Pin	Signal
1	+V5SB
2	GND
3	PS_ON#

## A.24 MINIPCIIE and mSATA Connector (MINI-PCIE1)



### MINIPCIIE:

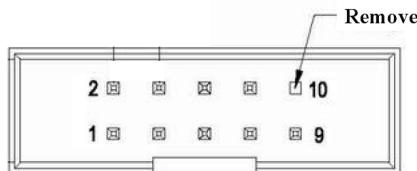
Pin	Signal	Pin	Signal
1	WAKE#	2	+3.3Vaux
3	Reserved	4	GND
5	Reserved	6	+1.5V
7	CLKREQ#	8	Reserved
9	GND	10	Reserved
11	REFCLK-	12	Reserved
13	REFCLK+	14	Reserved
15	GND	16	Reserved
17	Reserved	18	GND
19	Reserved	20	DISABLE#
21	DETECT#	22	RESET#
23	PCIE_RX+	24	+3.3Vaux
25	PCIE_RX-	26	GND
27	GND	28	+1.5V
29	GND	30	SMB_CLK
31	PCIE_TX-	32	SMB_DATA
33	PCIE_TX+	34	GND
35	GND	36	USB_D-
37	GND	38	USB_D+
39	+3.3Vaux	40	GND
41	+3.3Vaux	42	Reserved

43	V1.2_DETECT#	44	LED_WLAN#
45	Reserved	46	Reserved
47	Reserved	48	+1.5V
49	Reserved	50	GND
51	MSATA_DETECT#	52	+3.3Vaux

**mSATA:**

Pin	Signal	Pin	Signal
1	Reserved	2	+3.3V
3	Reserved	4	GND
5	Reserved	6	+1.5V
7	Reserved	8	Reserved
9	GND	10	Reserved
11	Reserved	12	Reserved
13	Reserved	14	Reserved
15	GND	16	Reserved
17	Reserved	18	GND
19	Reserved	20	Reserved
21	DETECT#	22	Reserved
23	RX+	24	+3.3V
25	RX-	26	GND
27	GND	28	+1.5V
29	GND	30	SMB_CLK
31	TX-	32	SMB_DATA
33	TX+	34	GND
35	GND	36	Reserved
37	GND	38	Reserved
39	+3.3V	40	GND
41	+3.3V	42	Reserved
43	Reserved	44	Reserved
45	Reserved	46	Reserved
47	Reserved	48	+1.5V
49	Reserved	50	GND
51	MSATA_DETECT#	52	+3.3V

## A.25 COM Port (COM2)



Pin	Signal	Pin	Signal
1	DCD#	6	DSR#
2	RXD	7	RTS#

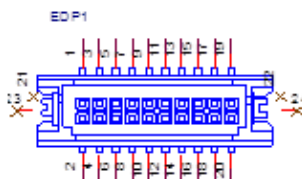
3	TXD	8	CTS#
4	DTR#	9	RI#
5	GND		

## A.26 eDP/LVDS Backlight Inverter Power Connector (INV1)



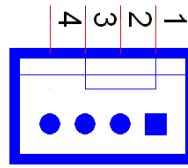
Pin	Signal
1	+12V
2	GND
3	BKL_EN
4	BKL_CTRL
5	+5V

## A.27 Embedded Display Port Connector (EDP1)



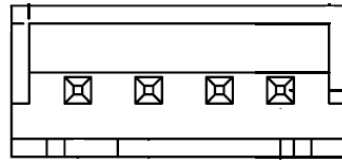
Pin	Signal	Pin	Signal
1	GND	2	GND
3	EDP0-	4	EDP3-
5	EDP0+	6	EDP3+
7	GND	8	N.C
9	EDP1-	10	GND
11	EDP1+	12	EAUX-
13	GND	14	EAUX+
15	EDP2-	16	GND
17	EDP2+	18	DP_HPD
19	VDD_EDP	20	VDD_EDP

## A.28 SYSTEM FAN Power Connector (SYSFAN1)



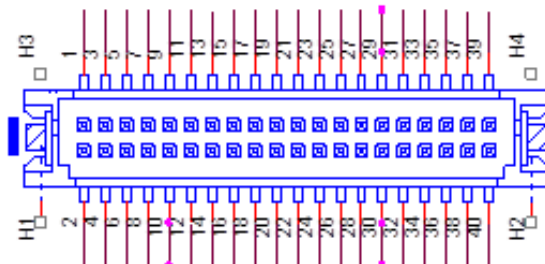
Pin	Signal
1	GND
2	+12V
3	DETECT
4	PWM IN

## A.29 SATA Power Connector (SATA\_PWR1/ SATA\_PWR2)



Pin	Signal	Pin	Signal
1	+V5	3	GND
2	GND	4	+V12

## A.30 LVDS Panel Connector (LVDS1)



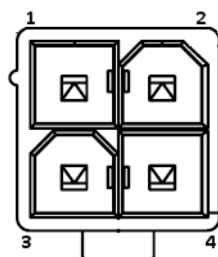
Pin	Signal	Pin	Signal
1	VDD	2	VDD
3	LVDS_DET#	4	GND
5	VDD	6	VDD
7	OD0-	8	ED0-
9	OD0+	10	ED0+
11	GND	12	GND
13	OD1-	14	ED1-

15	OD1+	16	ED1+
17	GND	18	GND
19	OD2-	20	ED2-
21	OD2+	22	ED2+
23	GND	24	GND
25	OCK-	26	ECK-
27	OCK+	28	ECK+
29	GND	30	GND
31	DDC_CLK	32	DDC_DAT
33	GND	34	GND
35	OD3-	36	ED3-
37	OD3+	38	ED3+
39	LVDS_ENBKL	40	VCON

**Note!** Please connect Pin3 to any GND pin on LVDS panel to enable LVDS.

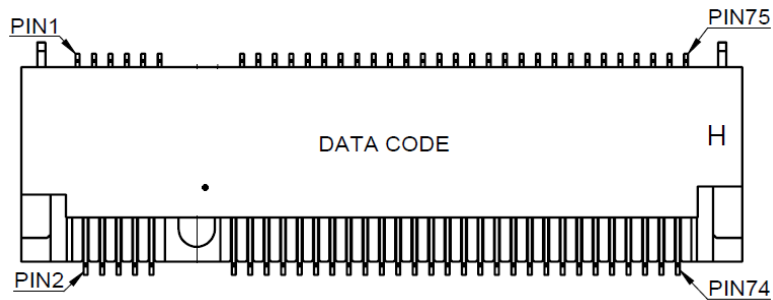


### A.31 ATX 12V Power Supply Connector (ATX12V1)



Pin	Signal
1	GND
2	GND
3	+12V
4	+12V

## A.32 Next Generation Form Factor (M.2\_1)

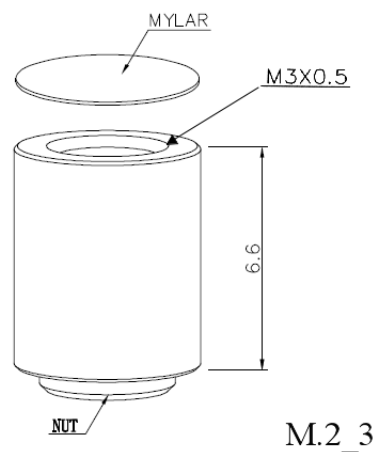
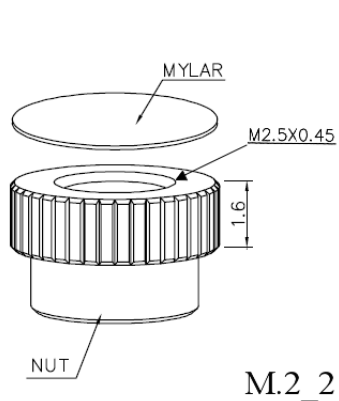


Pin	Signal	Pin	Signal
1	M.2_CONFIG_3	2	+Vcc(3.3v)
3	GND	4	+Vcc(3.3v)
5	GND	6	POWER_OFF#
7	USB2_PCH_D0+	8	Wireless Module disable#
9	USB2_PCH_D0-	10	LED detect#
11	GND	12	Module Key
13	Module Key	14	Module Key
15	Module Key	16	Module Key
17	Module Key	18	Module Key
19	Module Key	20	x
21	M.2_CONFIG_0	22	x
23	PCIe wake up#	24	x
25	DPR(Dynamic Power Reduction)	26	GNSS_DISABLE#
27	GND	28	x
29	M.2_PCIE_RX1-	30	X
31	M.2_PCIE_RX1+	32	X
33	GND	34	X
35	M.2_PCIE_TX1-	36	X
37	M.2_PCIE_TX1+	38	X
39	GND	40	GNSS_SCL
41	M.2_PCIE_RX0+	42	GNSS_SDA
43	M.2_PCIE_RX0-	44	X
45	GND	46	X
47	M.2_PCIE_TX0-	48	X
49	M.2_PCIE_TX0+	50	Platform Reset#
51	GND	52	Clock request#
53	CLK100M_M.2-	54	PCI_WAKE#
55	CLK100M_M.2+	56	SMBUS Data
57	GND	58	SMBUS Clock
59	X	60	X
61	X	62	X
63	X	64	X
65	X	66	x

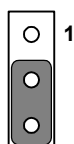


67	Wireless Module Reset#	68	SUSCLK(32kHz)
69	M.2_CONFIG_1	70	+Vcc(3.3v)
71	GND	72	+Vcc(3.3v)
73	GND	74	+Vcc(3.3v)
75	M.2_CONFIG_2		

### A.33 M.2 Screw \_42\*22mm & 42\*30mm (M.2\_2) M.2 Screw \_80\*22mm (M.2\_3)

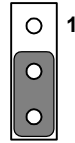


### A.34 LVDS VESA, JEIDA format selection pin header (JLVDS\_VCON1)



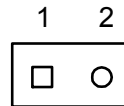
Pin	Signal
1	+3.3V
2	OPTION
3	GND

## A.35 Case open selection pin header (JCASEOP\_SW1)



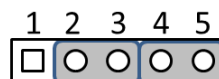
Pin	Signal
1	CASEOP# w/ normal close switch
2	CASE OPEN Setting
3	CASEOP w/ normal open switch

## A.36 Case-Open Detect Connector (JCASE1)



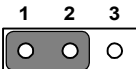
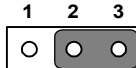
Pin	Signal
1	Intruder#
2	Gnd

## A.37 Watchdog Timer Output and OBS Beep (JWDT1+JOBS1)



Pin	Signal
1	NC
2	Watch dog reset# output
3	System reset input#
4	SIO Warning Beep output
5	SP1 Buzzer Beep input

## A.38 SATA Power connector (JSATAPWR1)

Function	Jumper Setting
SATA DOM to GND (Default)	 1 and 2
SATA DOM to Power(+5V)	 2 and 3

**ADVANTECH**

*Enabling an Intelligent Planet*

**[www.advantech.com](http://www.advantech.com)**

Please verify specifications before quoting. This guide is intended for reference purposes only.

All product specifications are subject to change without notice.

No part of this publication may be reproduced in any form or by any means, electronic, photocopying, recording or otherwise, without prior written permission of the publisher.

All brand and product names are trademarks or registered trademarks of their respective companies.

© Advantech Co., Ltd. 2016