

# 800U SERIES PUSHBUTTON SWITCH

ANTI-VANDAL SWITCHES  
 DETECTOR SWITCHES  
 DIP SWITCHES  
 KEYLOCK SWITCHES  
 NAVIGATION SWITCHES  
**PUSHBUTTON SWITCHES**  
 ROCKER SWITCHES  
 ROTARY SWITCHES  
 SLIDE SWITCHES  
 SNAP ACTION SWITCHES  
 TACTILE SWITCHES  
 TOGGLE SWITCHES  
 CAP OPTIONS

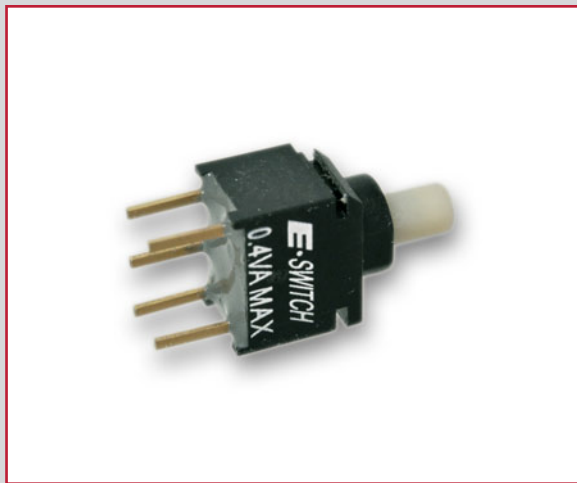

## APPLICATIONS / MARKETS

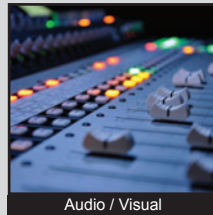

Audio / Visual

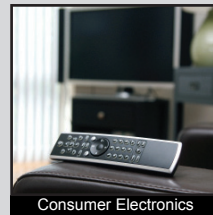

Consumer Electronics



Vending Machines

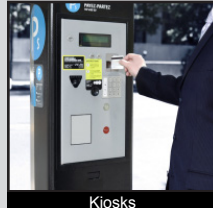

Kiosks

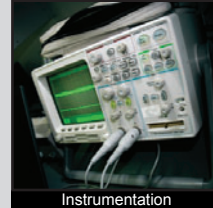

Instrumentation



Medical Equipment

# RoHS

## SPECIFICATIONS

**Electrical Rating:** 0.4VA @ 20V Max (AC or DC)  
**Mechanical Life:** 40,000 Cycles  
**Electrical Life:** 6,000 Cycles  
**Contact Resistance:** 100mΩ initial  
**Insulation Resistance:** 500 MΩ Min.  
**Dielectric Strength:** 500VAC  
**Operating/Storage Temperature:** -30°C to 85°C  
**Travel:** 1.0mm  
**Circuit Function:** SPDT, DPDT  
**Actuation Force:** 250 gf

## FEATURES & BENEFITS

- Ultra-miniature in size
- IP67 rated
- Multiple termination options
- Multiple cap colors
- Single or double pole

## PART NUMBER CONFIGURATOR

Series	Circuit	Function	Actuator	Bushing	Terminal	Contact Material	Seal	Cap	Cap Color
<input type="text" value="800U"/>	<input type="text" value="SP"/> <input type="text" value="DP"/>	<input type="text" value="8"/>	<input type="text" value="P1"/>	<input type="text" value="A1"/>	<input type="text" value="M2"/> <input type="text" value="M6"/> <input type="text" value="M7"/>	<input type="text" value="R"/>	<input type="text" value="E"/>	<input type="text" value="None"/> <input type="text" value="R1"/>	<input type="text" value="None"/> <input type="text" value="BLK"/> <input type="text" value="RED"/> <input type="text" value="WHT"/>

### CAP CONFIGURATOR\*

Series	Cap Style	Cap Color
<input type="text" value="800U"/>	<input type="text" value="R1"/>	<input type="text" value="BLK"/> <input type="text" value="RED"/> <input type="text" value="WHT"/>

\* ( ) denotes momentary

\*You can order just the switch with or without the cap using the first ordering code above, or you can order the cap as a separate part number using the smaller ordering code directly above.

Specifications subject to change without notice



**E-SWITCH®**

www.e-switch.com

800.867.2717

2

# 800U SERIES PUSHBUTTON SWITCH

## SPDT DIMENSIONS

### M2 Termination

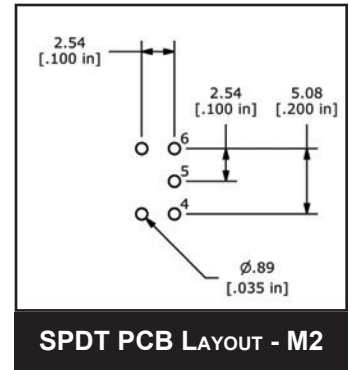
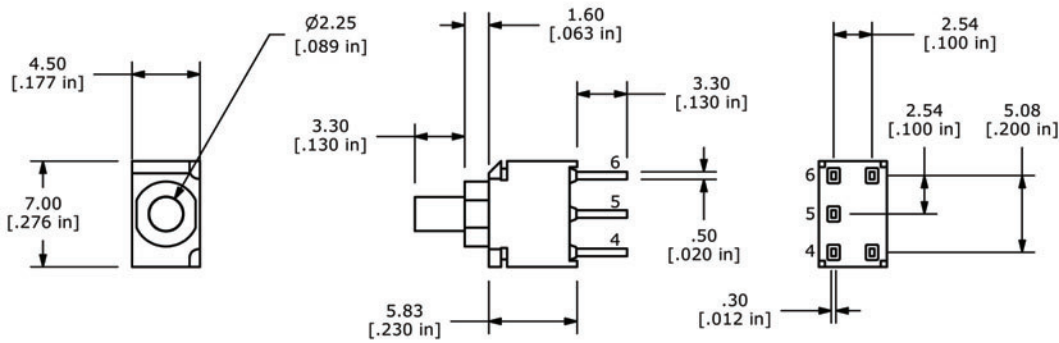

### M6 Termination

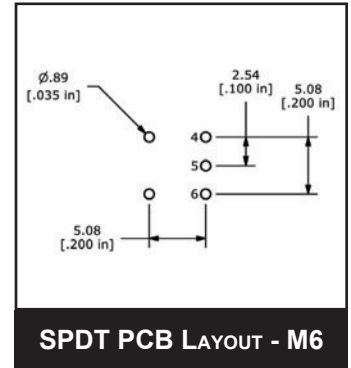
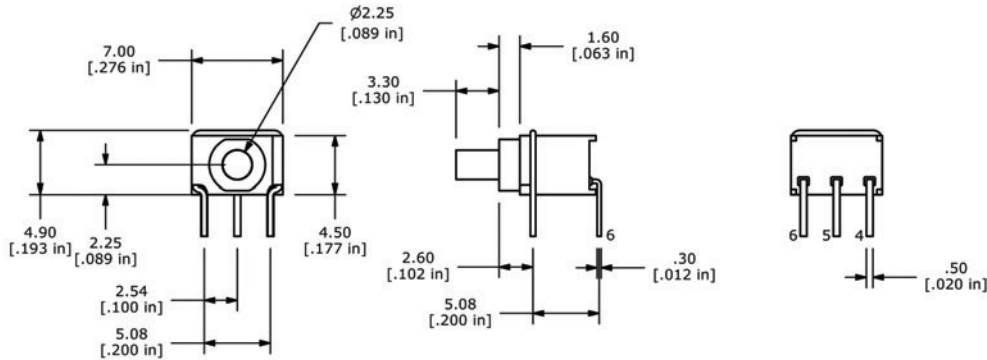

### M7 Termination

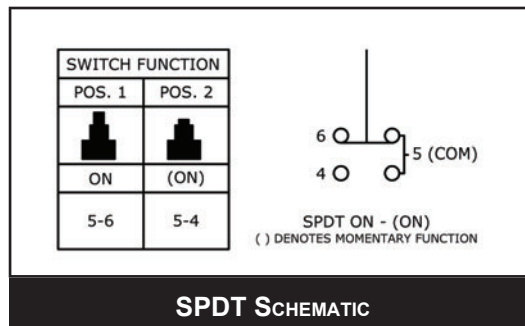
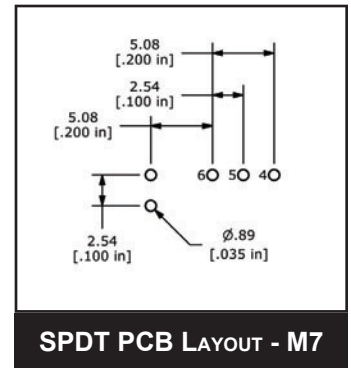
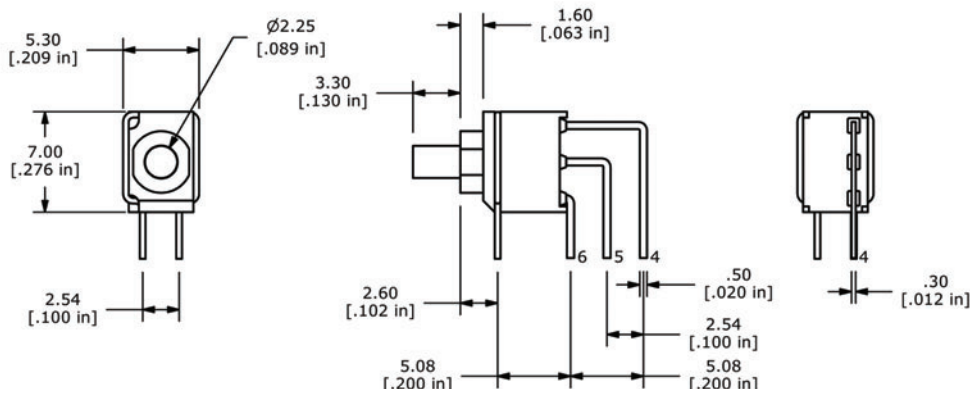

ANTI-VANDAL SWITCHES  
 DETECTOR SWITCHES  
 DIP SWITCHES  
 KEYLOCK SWITCHES  
 NAVIGATION SWITCHES  
**PUSHBUTTON SWITCHES**  
 ROCKER SWITCHES  
 ROTARY SWITCHES  
 SLIDE SWITCHES  
 SNAP ACTION SWITCHES  
 TACTILE SWITCHES  
 TOGGLE SWITCHES  
 CAP OPTIONS

# 800U SERIES PUSHBUTTON SWITCH

## DPDT DIMENSIONS

### M2 Termination

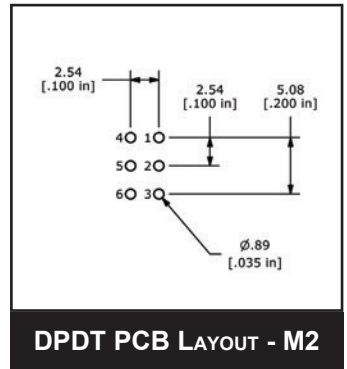
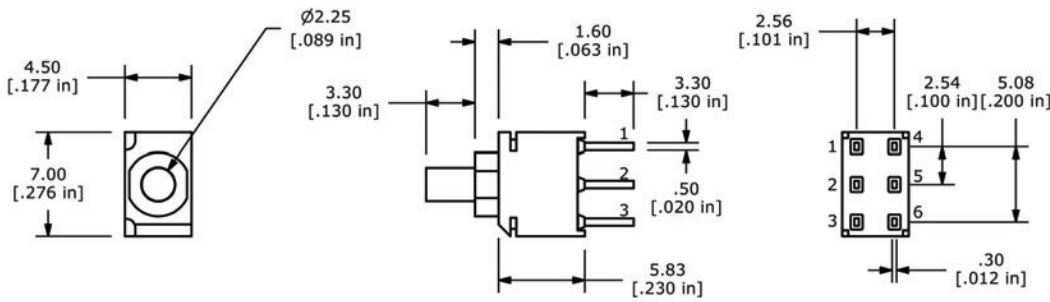

DPDT PCB LAYOUT - M2

### M6 Termination

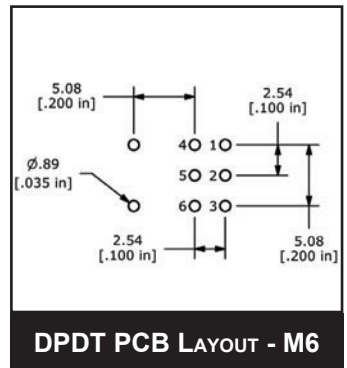
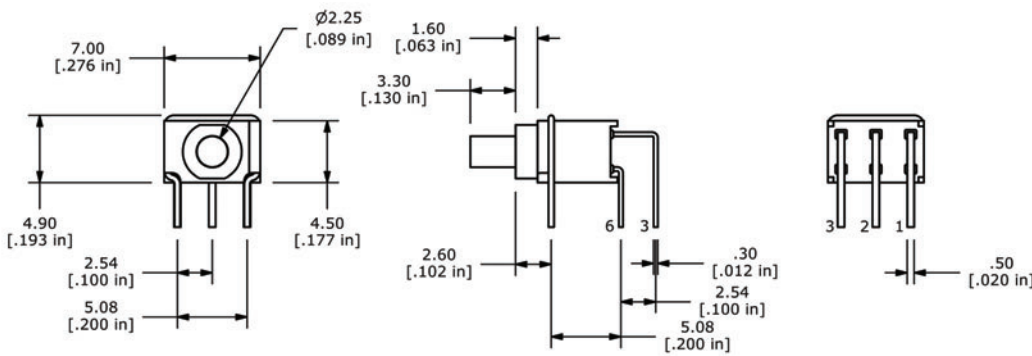

DPDT PCB LAYOUT - M6

### M7 Termination

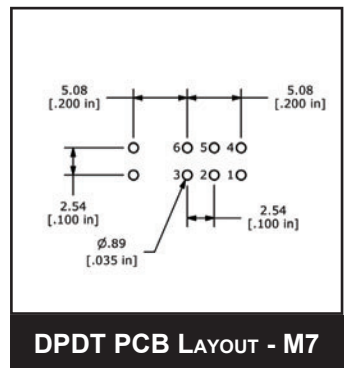
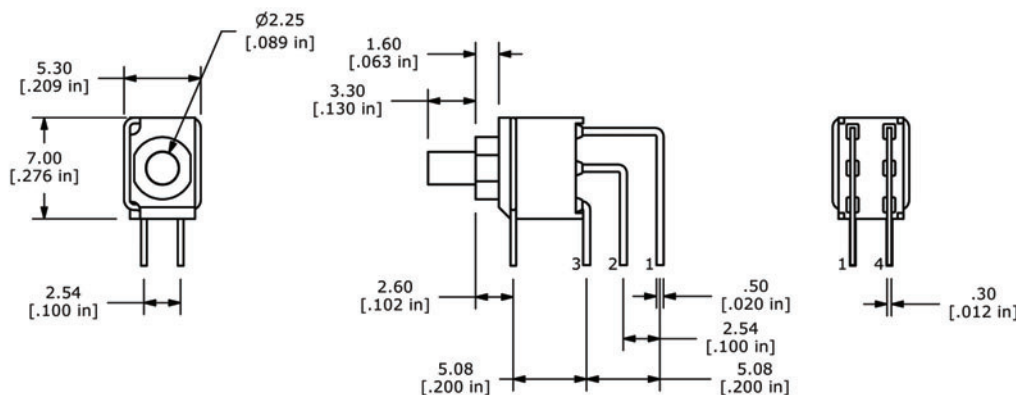

DPDT PCB LAYOUT - M7

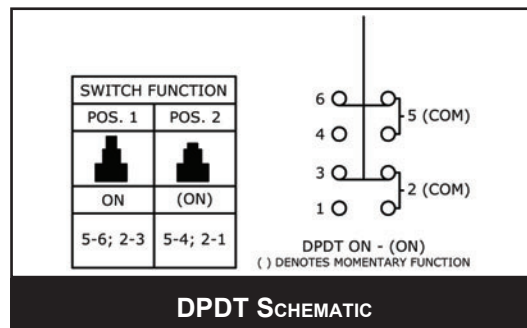

DPDT SCHEMATIC



## BUTTON POSITIONING

For specifications, please refer to the dimensions on previous pages.

### M2 Button

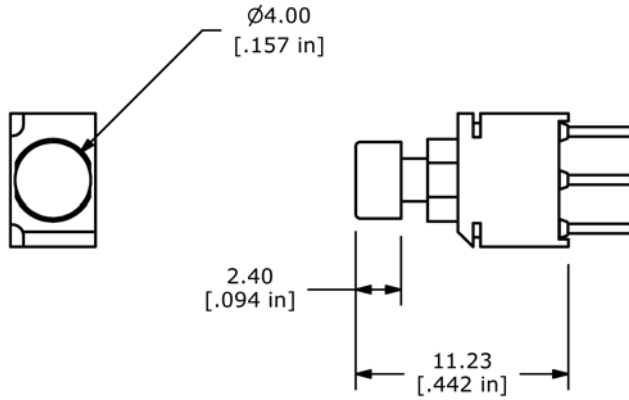

### M6 Button

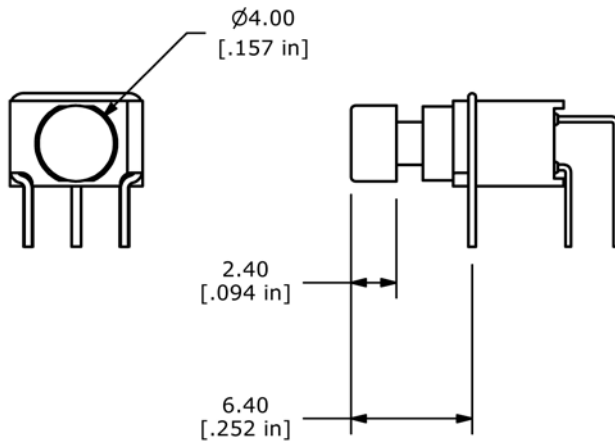

### M7 Button

