

RF360 Europe GmbH

A Qualcomm – TDK Joint Venture

SAW Components

SAW Duplexer

Cellular / LTE Band 11

Series/type:	B8632
Ordering code:	B39142B8632P810
Date:	July 17, 2014
Version:	2.2

RF360 products mentioned within this document are offered by RF360 Europe GmbH and other subsidiaries of RF360 Holdings Singapore Pte. Ltd. (collectively, the “RF360 Subsidiaries”). RF360 Holdings Singapore Pte. Ltd. is a joint venture of Qualcomm Global Trading Pte. Ltd. and EPCOS AG. References in this documentation to EPCOS AG should properly reference, and shall be read to reference, the RF360 Subsidiaries.

RF360 Europe GmbH, Anzinger Str. 13, München, Germany

© 2016 RF360 Europe GmbH and/or its affiliated companies. All rights reserved.

These materials, including the information contained herein, may be used only for informational purposes by the customer. The RF360 Subsidiaries assume no responsibility for errors or omissions in these materials or the information contained herein. The RF360 Subsidiaries reserve the right to make changes to the product(s) or information contained herein without notice. The materials and information are provided on an AS IS basis, and the RF360 Subsidiaries assume no liability and make no warranty or representation, either expressed or implied, with respect to the materials, or any output or results based on the use, application, or evaluation of such materials, including, without limitation, with respect to the non-infringement of trademarks, patents, copyrights or any other intellectual property rights or other rights of third parties.

No use of this documentation or any information contained herein grants any license, whether express, implied, by estoppel or otherwise, to any intellectual property rights, including, without limitation, to any patents owned by QUALCOMM Incorporated or any of its subsidiaries.

Not to be used, copied, reproduced, or modified in whole or in part, nor its contents revealed in any manner to others without the express written permission of RF360 Europe GmbH.

Qualcomm and Qualcomm RF360 are trademarks of Qualcomm Incorporated, registered in the United States and other countries. RF360 is a trademark of Qualcomm Incorporated. Other product and brand names may be trademarks or registered trademarks of their respective owners.

This technical data may be subject to U.S. and international export, re-export, or transfer ("export") laws. Diversion contrary to U.S. and international law is strictly prohibited.



SAW Components

SAW Duplexer

Cellular / LTE Band 11

Series/type: B8632
Ordering code: B39142B8632P810

Date: July 17, 2014
Version: 2.2

© EPCOS AG 2015. Reproduction, publication and dissemination of this publication, enclosures hereto and the information contained therein without EPCOS' prior express consent is prohibited.

EPCOS AG is a TDK Group Company.

Data sheet



Application

- Multimode SAW duplexer for mobile telephone Cellular / LTE Band 11 systems
- Low insertion attenuation
- Low amplitude ripple

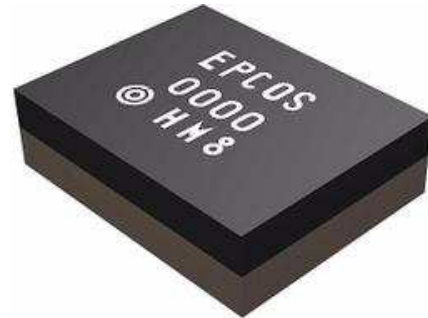

Features

- Package size 1.8 x 1.4 mm³
- Max. package height 0.475 mm
- RoHS compatible
- Approx. weight 0.0042g
- Package for **Surface Mount Technology (SMT)**
- Ni, Au-plated terminals
- **Electrostatic Sensitive Device (ESD)**
- **Moisture Sensitivity Level 3**

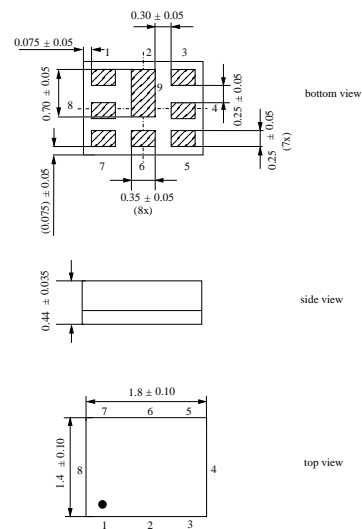

Pin configuration

- 3 TX Input
- 1 RX Output
- 6 Antenna
- 2, 4, 5, 7,8 To be grounded

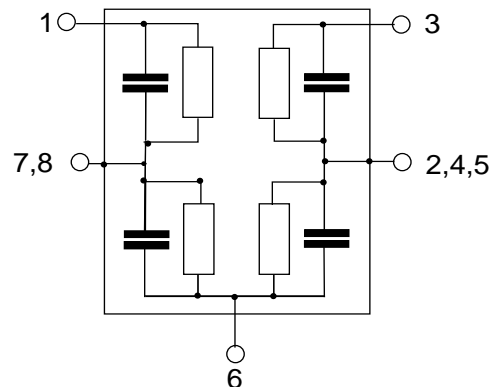

Data sheet

Characteristics

Temperature range for specification:	T = -30 °C to + 90 °C
Antenna terminating impedance:	Z _{ANT} = 50 Ω 6.2 nH
RX terminating impedance:	Z _{RX} = 50 Ω
TX terminating impedance:	Z _{TX} = 50 Ω

Characterisitcs TX - ANT				min.	typ. @ 25 °C	max.	
Center frequency	f _C			—	1437.9	—	MHz
Maximum insertion attenuation	α _{max}			—	1.4	1.9	dB
1427.9 ... 1447.9	MHz						
Amplitude ripple (p-p)	Δα			—	0.3	1.0	dB
1427.9 ... 1447.9	MHz						
Input VSWR (TX port)				—	1.5	2.0	
1427.9 ... 1447.9	MHz						
Output VSWR (ANT port)				—	1.4	2.0	
1427.9 ... 1447.9	MHz						
Attenuation	α						
10.0 ... 1390.0	MHz			29	32	—	dB
1390.0 ... 1409.0	MHz			5	9	—	dB
1475.9 ... 1495.9	MHz			45	54	—	dB
1559.0 ... 1563.0	MHz			40	47	—	dB
1565.420 ... 1573.374	MHz			35	47	—	dB
1573.374 ... 1577.466	MHz			40	47	—	dB
1577.466 ... 1585.420	MHz			35	47	—	dB
1597.5515 ... 1605.887	MHz			40	48	—	dB
1607.0 ... 1680.0	MHz			25	48	—	dB
1844.9 ... 1879.9	MHz			30	43	—	dB
1884.5 ... 1919.6	MHz			15	42	—	dB
2010.0 ... 2025.0	MHz			30	42	—	dB
2110.0 ... 2170.0	MHz			30	39	—	dB
2400.0 ... 2483.5	MHz			29	34	—	dB
2855.8 ... 2905.8	MHz			25	29	—	dB
4283.7 ... 4358.7	MHz			18	23	—	dB
4900.0 ... 5850.0	MHz			15	22	—	dB

Data sheet

Characteristics

Temperature range for specification:	T = -30 °C to +90 °C
Antenna terminating impedance:	Z _{ANT} = 50 Ω 6.2 nH
RX terminating impedance:	Z _{RX} = 50 Ω
TX terminating impedance:	Z _{TX} = 50 Ω

Characterisitcs ANT - RX				min.	typ. @ 25 °C	max.	
Center frequency	f _C			—	1485.9	—	MHz
Maximum insertion attenuation	α _{max}						
1475.9 ... 1495.9	MHz			—	1.7	2.3 ¹⁾	dB
1475.9 ... 1495.9	MHz			—	1.7	2.4	dB
Amplitude ripple(p-p)	Δα						
1475.9 ... 1495.9	MHz			—	0.7	1.1	dB
Input VSWR (ANT port)							
1475.9 ... 1495.9	MHz			—	1.5	2.0	
Output VSWR (RX port)							
1475.9 ... 1495.9	MHz			—	1.5	2.0	
Attenuation	α						
10.0 ... 1427.9	MHz			40	48	—	dB
	48.0	MHz		60	97	—	dB
814.0 ... 849.0	MHz			40	49	—	dB
1427.9 ... 1447.9	MHz			45	51	—	dB
1452.0 ... 1460.0	MHz			5	11	—	dB
1581.0 ... 6000.0	MHz			25	30	—	dB
2400.0 ... 2500.0	MHz			40	46	—	dB
4427.7 ... 4487.7	MHz			34	42	—	dB
4900.0 ... 5950.0	MHz			25	29	—	dB
IMD product level limits²⁾							
at f_{TX}=1437.9MHz, f_{RX}=1485.9MHz							
Blocker 1	48.0	MHz		—	-135	-109	dBm
Blocker 3	1389.9	MHz		—	-99	-86	dBm
Blocker 3	2923.8	MHz		—	-109	-95	dBm
Blocker 4	4361.7	MHz		—	-111	-91	dBm

1) For temperature range -30 °C to +85 °C

2) IMD product level limits for power levels P_{TX}=21.5 dBm (antenna port output power) and P_{Blocker}=-15dBm (antenna port input power).

Data sheet

Characteristics

Temperature range for specification:	T = -30 °C to +90 °C
Antenna terminating impedance:	Z _{ANT} = 50 Ω 6.2 nH
RX terminating impedance:	Z _{RX} = 50 Ω
TX terminating impedance:	Z _{TX} = 50 Ω

Characterisitcs TX - RX			min.	typ. @ 25 °C	max.	
Isolation		α				
	1427.9 ... 1447.9	MHz	55	60	—	dB
	1475.9 ... 1495.9	MHz	50	57	—	dB
	1574.0 ... 1577.0	MHz	30	61	—	dB
	2855.8 ... 2905.8	MHz	30	50	—	dB
	4283.7 ... 4358.7	MHz	25	45	—	dB

Maximum ratings

Storage temperature range	T _{stg}	-40/+85	°C	
DC voltage	V _{DC}	5 ¹⁾	V	
ESD voltage	V _{ESD}	50 ²⁾	V	Machine Model
		150 ³⁾	V	Human Body Model
		600 ⁴⁾	V	Charged Device Model
Input power	P _{IN}			source and load impedance 50 Ω
1427.9 ... 1447.9 MHz		29	dBm	} continuous wave T = 50°C, 5000 h
elsewhere		10	dBm	

1) 168h Damp Heat Steady State acc. to IEC60068-2-67 Cy

2) acc. to JESD22-A115B (MM - Machine Model), 10 negative & 10 positive pulses.

3) acc. to JESD22-A114F (HBM - Human Body Model), 1 negative & 1 positive pulses.

4) acc. to JESD22-C101C (CDM - Filed Induced Charged Device Model), 3 negative & 3 positive pulses.

Data sheet



Frequency Response Tx-Ant

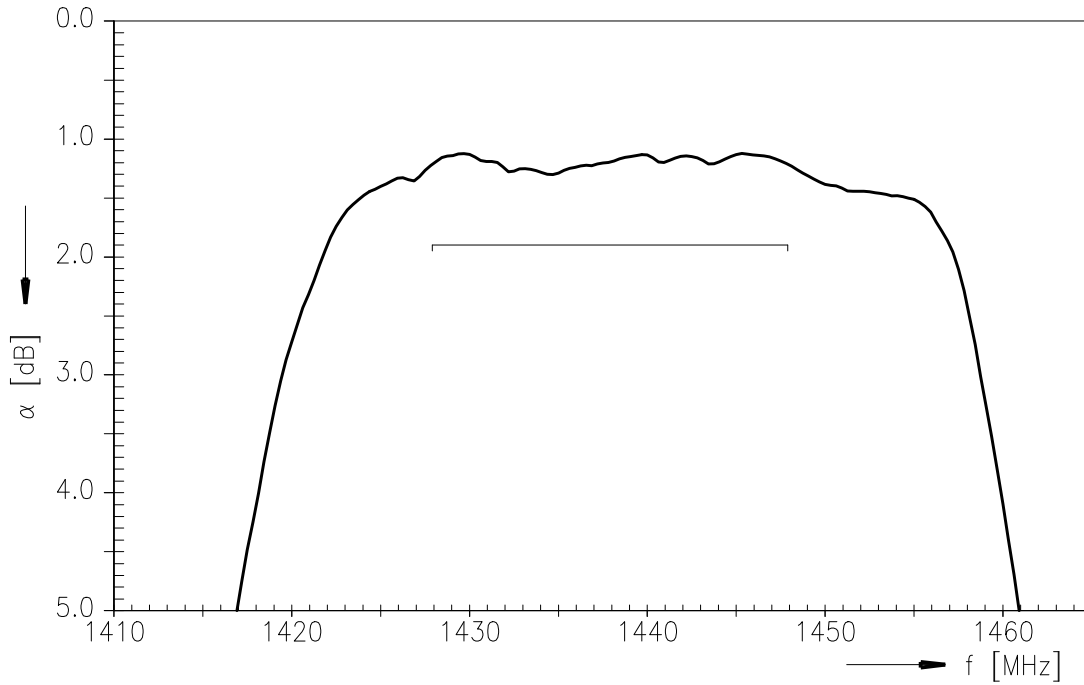

Frequency Response Ant-Rx

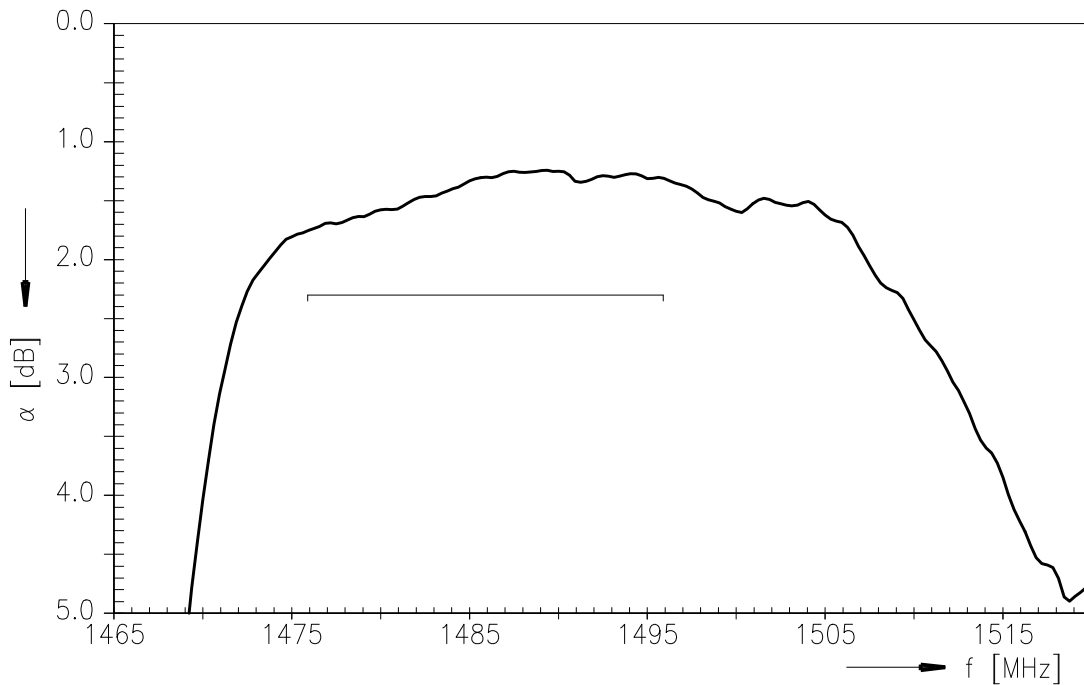

Data sheet



Frequency Response Tx-Ant

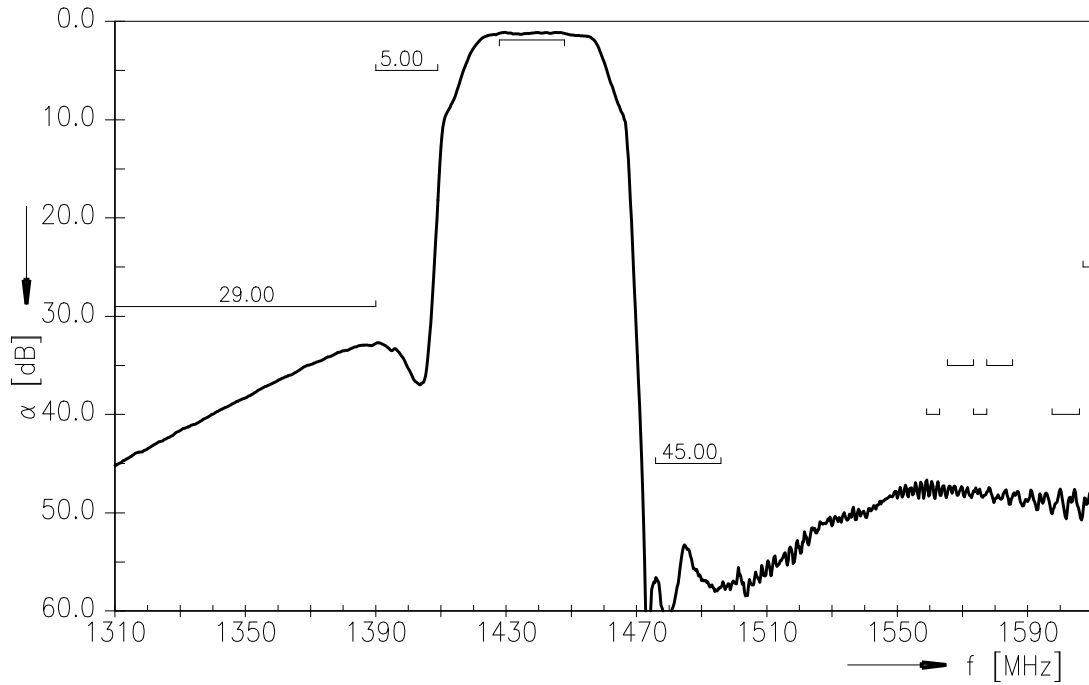

Frequency Response Tx-Ant (wideband)

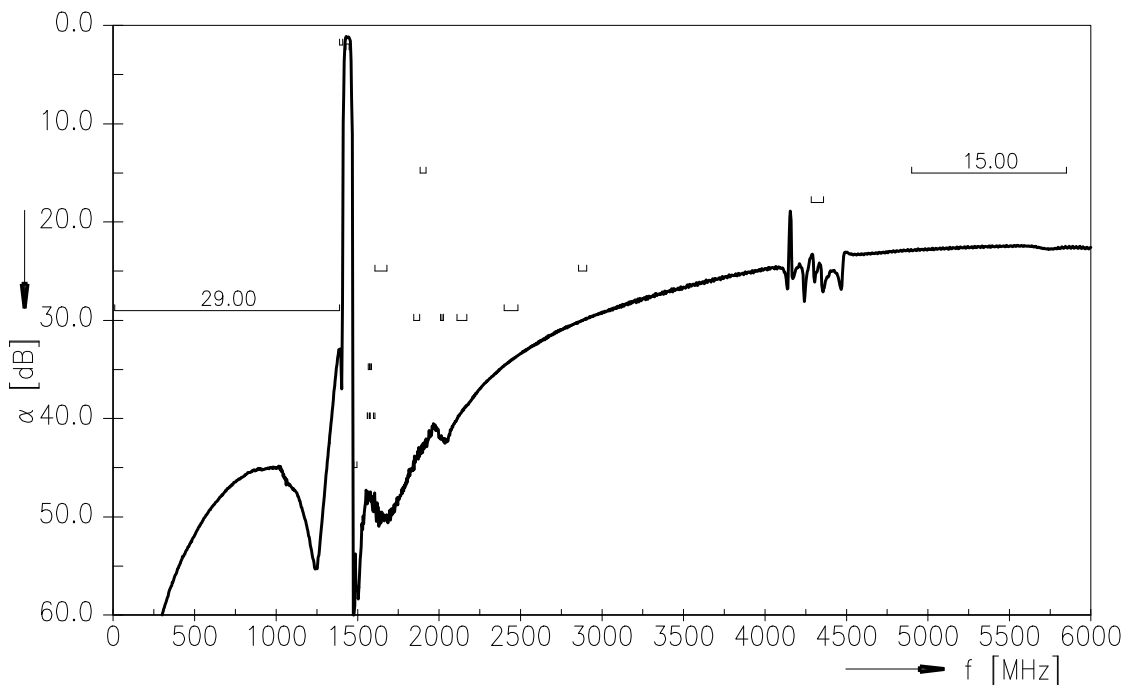

Data sheet



Frequency Response Rx-Ant

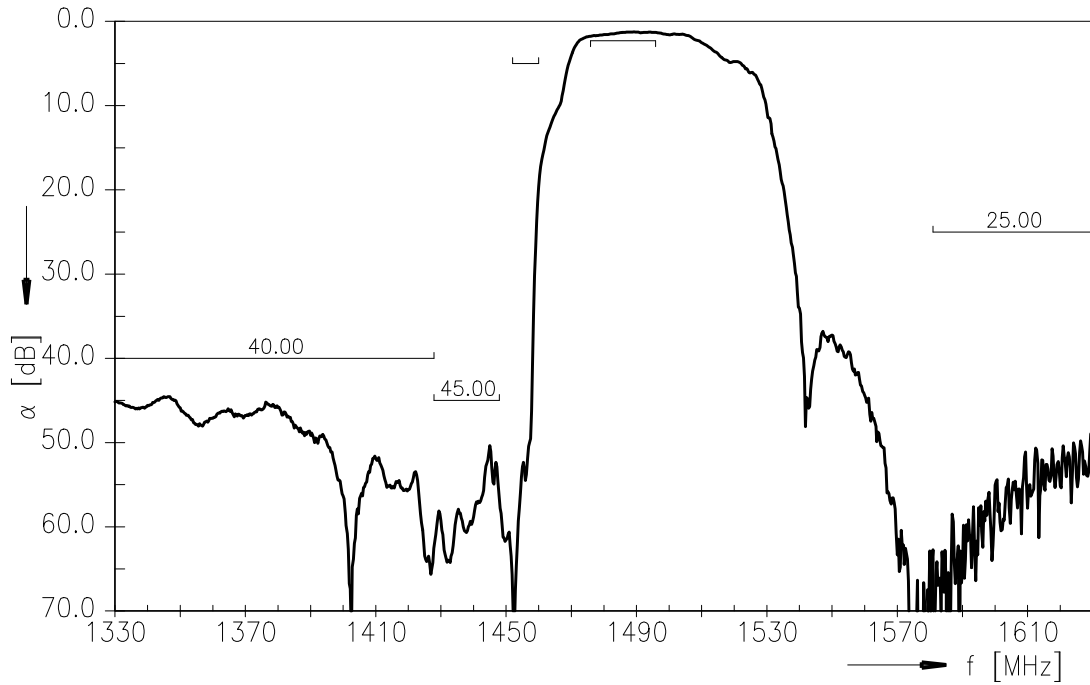

Frequency Response RX-ANT (wideband)

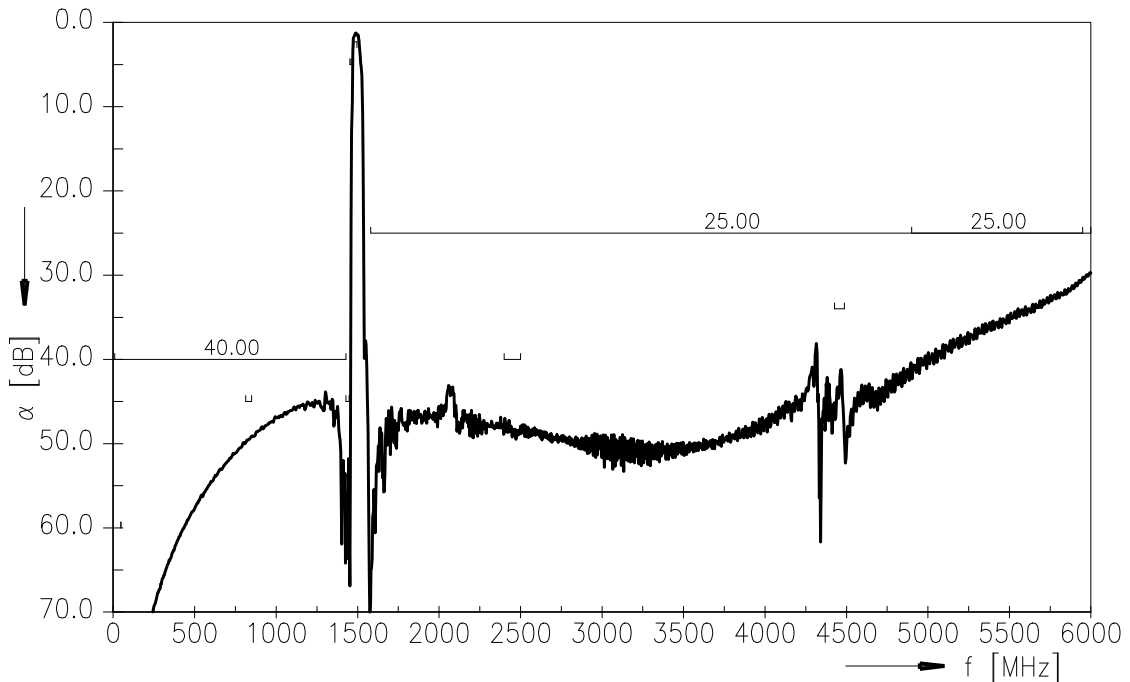

Data sheet



Frequency Response Tx-Rx

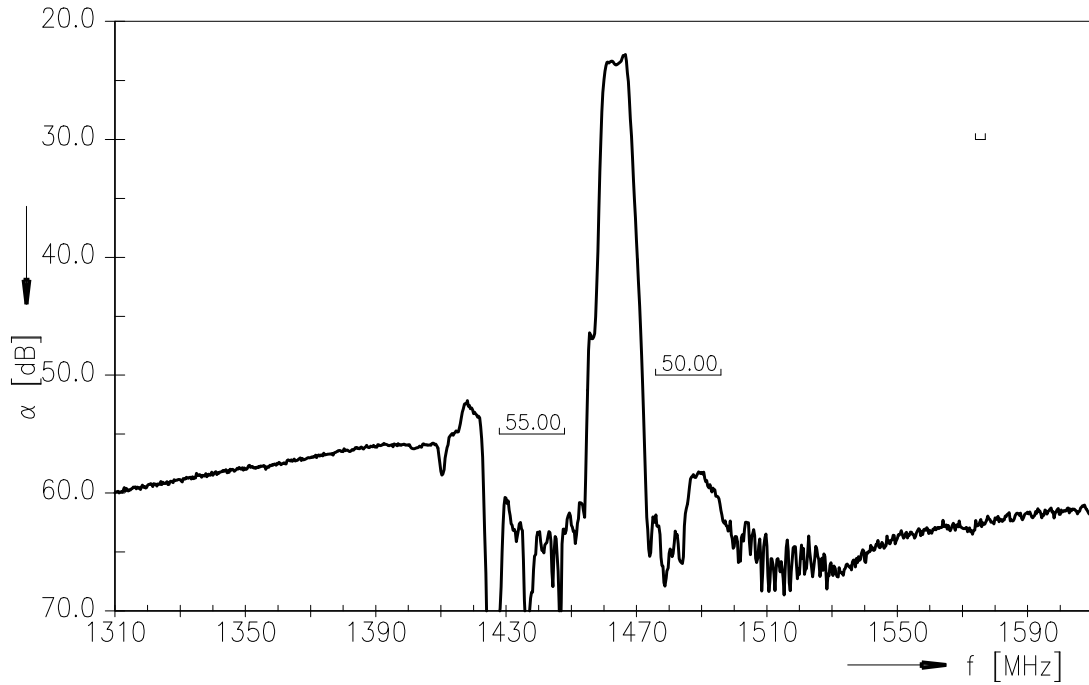

Frequency Response Tx-Rx (wideband)

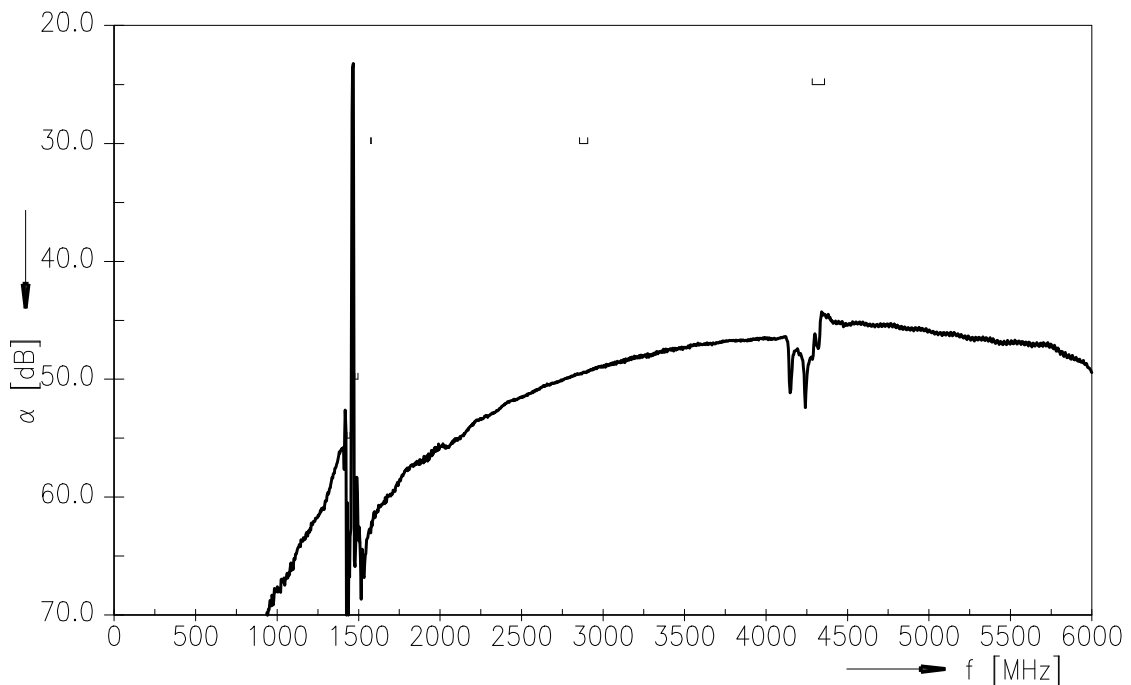

SAW Components **B8632**
SAW Duplexer **1437.9 / 1485.9 MHz**

Data sheet



VSWR **S₁₁ TX-port** **S₂₂ ANT-port** **S₃₃ RX-port**

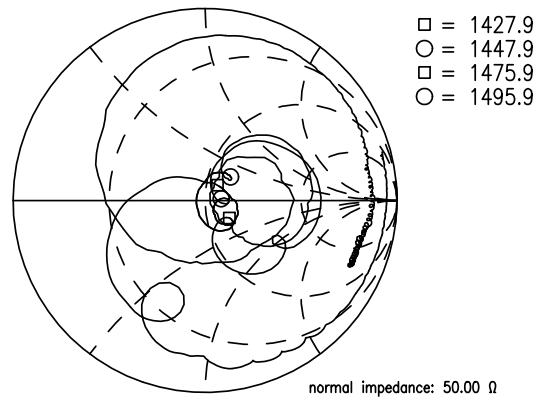
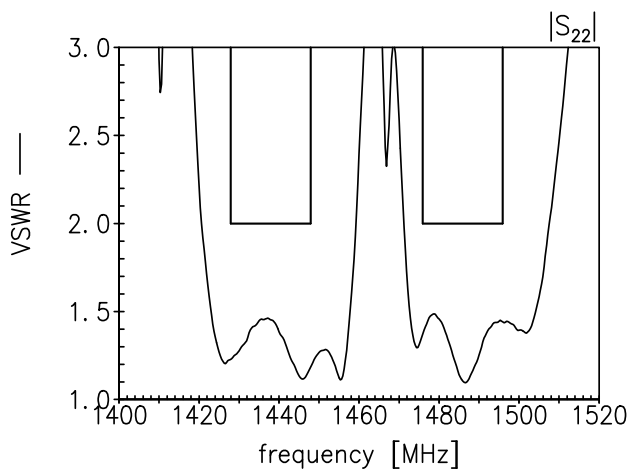
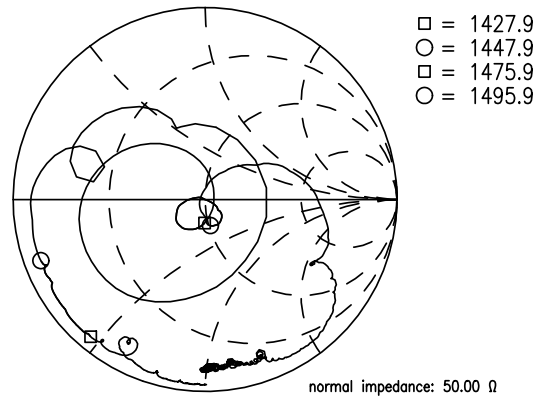
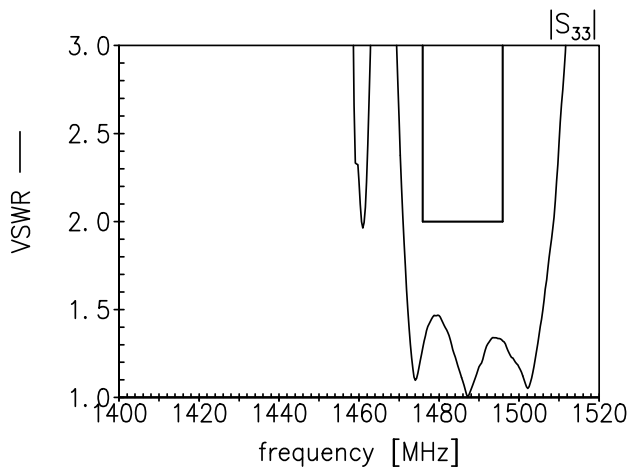
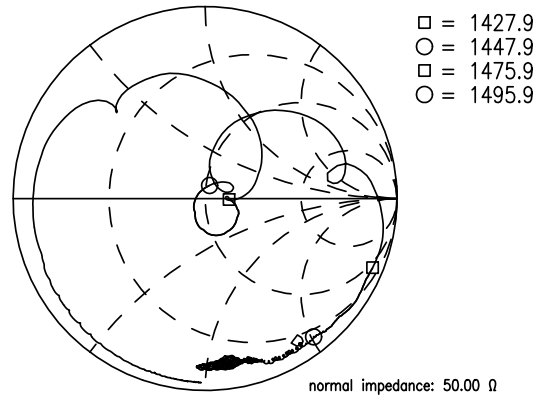
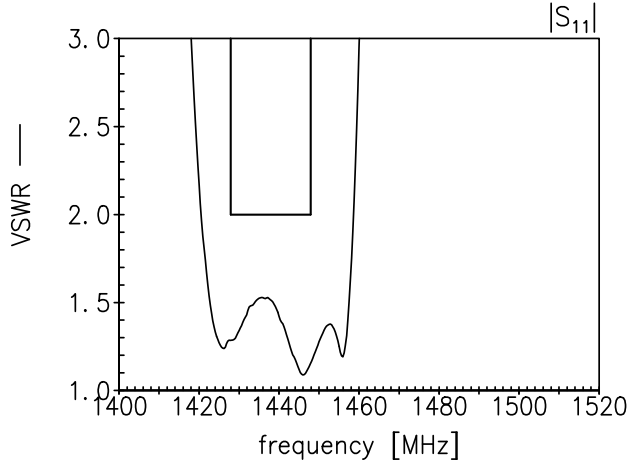

SAW Components	B8632
SAW Duplexer	1437.9 / 1485.9 MHz

Data sheet



References

Type	B8632
Ordering code	B39142B8632P810
Marking and package	C61157-A8-A68
Packaging	F61074-V8259-Z000
Date codes	L_1126
S-parameters	B8632_NB_UN.s3p, B8632_WB_UN.s3p see file header for port/pin assignment table
Soldering profile	S_6001
RoHS compatible	RoHS-compatible means that products are compatible with the requirements according to Art. 4 (substance restrictions) of Directive 2011/65/EU of the European Parliament and of the Council of June 8 th , 2011, on the restriction of the use of certain hazardous substances in electrical and electronic equipment ("Directive") with due regard to the application of exemptions as per Annex III of the Directive in certain cases.
Moldability	Before using in overmolding environment, please contact your EPCOS sales office.
Matching coils	See Inductor pdf-catalog http://www.tdk.co.jp/tefe02/coil.htm#aname1 and Data Library for circuit simulation http://www.tdk.co.jp/etvcl/index.htm

For further information please contact your local EPCOS sales office or visit our webpage at www.epcos.com .

Published by EPCOS AG
Systems, Acoustics, Waves Business Group
P.O. Box 80 17 09, 81617 Munich, GERMANY

© EPCOS AG 2014. This brochure replaces the previous edition.

For questions on technology, prices and delivery please contact the Sales Offices of EPCOS AG or the international Representatives.

Due to technical requirements components may contain dangerous substances. For information on the type in question please also contact one of our Sales Offices.

Important notes

The following applies to all products named in this publication:

1. Some parts of this publication contain **statements about the suitability of our products for certain areas of application**. These statements are based on our knowledge of typical requirements that are often placed on our products in the areas of application concerned. We nevertheless expressly point out **that such statements cannot be regarded as binding statements about the suitability of our products for a particular customer application**. As a rule, EPCOS is either unfamiliar with individual customer applications or less familiar with them than the customers themselves. For these reasons, it is always ultimately incumbent on the customer to check and decide whether an EPCOS product with the properties described in the product specification is suitable for use in a particular customer application.
2. We also point out that **in individual cases, a malfunction of electronic components or failure before the end of their usual service life cannot be completely ruled out in the current state of the art, even if they are operated as specified**. In customer applications requiring a very high level of operational safety and especially in customer applications in which the malfunction or failure of an electronic component could endanger human life or health (e.g. in accident prevention or life-saving systems), it must therefore be ensured by means of suitable design of the customer application or other action taken by the customer (e.g. installation of protective circuitry or redundancy) that no injury or damage is sustained by third parties in the event of malfunction or failure of an electronic component.
3. **The warnings, cautions and product-specific notes must be observed.**
4. In order to satisfy certain technical requirements, **some of the products described in this publication may contain substances subject to restrictions in certain jurisdictions (e.g. because they are classed as hazardous)**. Useful information on this will be found in our Material Data Sheets on the Internet (www.epcos.com/material). Should you have any more detailed questions, please contact our sales offices.
5. We constantly strive to improve our products. Consequently, **the products described in this publication may change from time to time**. The same is true of the corresponding product specifications. Please check therefore to what extent product descriptions and specifications contained in this publication are still applicable before or when you place an order. We also **reserve the right to discontinue production and delivery of products**. Consequently, we cannot guarantee that all products named in this publication will always be available. The aforementioned does not apply in the case of individual agreements deviating from the foregoing for customer-specific products.
6. Unless otherwise agreed in individual contracts, **all orders are subject to the current version of the "General Terms of Delivery for Products and Services in the Electrical Industry" published by the German Electrical and Electronics Industry Association (ZVEI)**.
7. The trade names EPCOS, BAOKE, Alu-X, CeraDiode, CeraLink, CeraPlas, CSMP, CSSP, CTVS, DeltaCap, DigiSiMic, DSSP, FilterCap, FormFit, MiniBlue, MiniCell, MKD, MKK, MLSC, MotorCap, PCC, PhaseCap, PhaseCube, PhaseMod, PhiCap, SIFERRIT, SIFI, SIKOREL, SilverCap, SIMDAD, SiMic, SIMID, SineFormer, SIOV, SIP5D, SIP5K, TFAP, ThermoFuse, WindCap are **trademarks registered or pending** in Europe and in other countries. Further information will be found on the Internet at www.epcos.com/trademarks.