



# 36V-Capable Overvoltage Protector with Regulated Output Voltage

MAX14562

## General Description

The MAX14562 protects valuable consumer circuits against voltage faults of up to +36V. This robust protection is implemented in a three-step scheme for a superior result. If the input is below the preset regulated output-voltage (VPROV) threshold, the output tracks the input minus the voltage drop (RON x ILOAD) across the pass FET. If the input exceeds VPROV, the output is regulated to VPROV. If the input rises further and exceeds the overvoltage lockout cutoff threshold (VOVLO), the output is disconnected from the input.

A low resistance 160mΩ (typ) FET is integrated in the MAX14562, effectively reducing the component count and application footprint. The MAX14562 also features thermal shutdown protection against a short-circuit event.

The MAX14562 is specified over the extended -40°C to +85°C temperature range and is available in 8-pin TDFN (2mm x 2mm) package.

## Applications

- |                       |                        |
|-----------------------|------------------------|
| Mobile Phones         | Digital Cameras        |
| Smartphones           | Bluetooth Headset      |
| Portable Media Player | E-Book                 |
| PDAs                  | Mobile Internet Device |

## Features

- ◆ Input Voltage Protection Up to +36V
- ◆ Preset Regulated Output Voltage (+5.15V typ)
- ◆ Integrated 160mΩ (typ) N-Channel MOSFET Switch
- ◆ Soft-Start to Minimize In-Rush Current
- ◆ Overvoltage Cutoff Protection +8V (typ)
- ◆ Thermal Shutdown Protection
- ◆ -40°C to +85°C Operating Temperature Range

## Ordering Information

PART	TEMP RANGE	PIN-PACKAGE	TOP MARK
MAX14562ETA+T	-40°C to +85°C	8 TDFN-EP*	ADI

+ Denotes a lead(Pb)-free/RoHS-compliant package.

T = Tape and reel.

\*EP = Exposed pad.

## Typical Operating Circuit

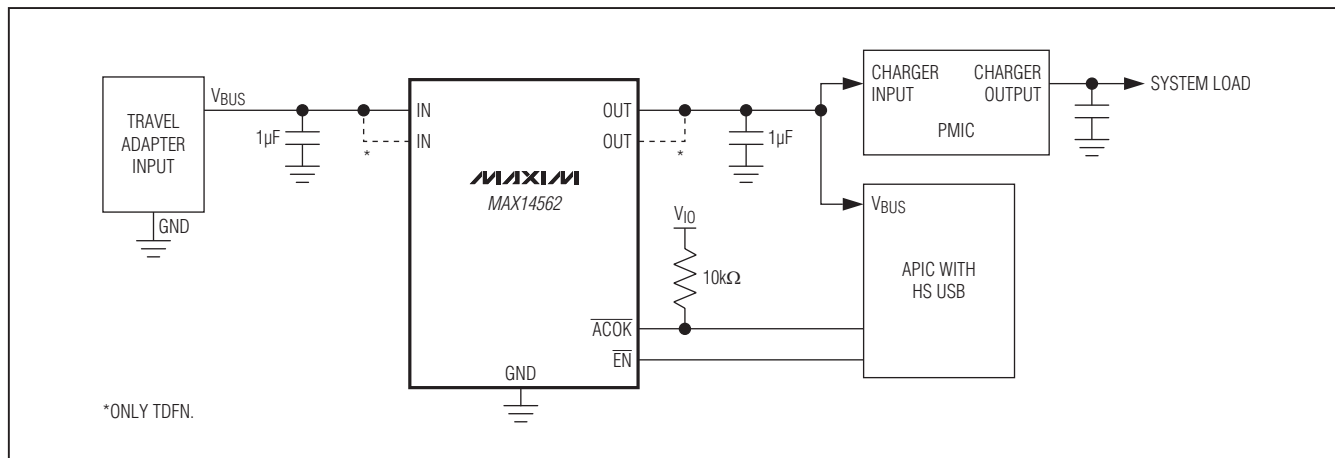

# 36V-Capable Overvoltage Protector with Regulated Output Voltage

## ABSOLUTE MAXIMUM RATINGS

(Voltages referenced to GND.)

IN	-0.3V to +40V
OUT	-0.3V to +6V
EN, ACOK	-0.3V to +6V
Continuous Current Through IN/OUT	
8-Pin TDFN	±1.6A
10ms Current Through IN/OUT	
8-Pin TDFN	±2A

Continuous Power Dissipation ( $T_A = +70^\circ\text{C}$ ):

8-Pin TDFN (derate 11.9mW/ $^\circ\text{C}$ above $+70^\circ\text{C}$ )	953mW
Operating Temperature Range	$-40^\circ\text{C}$ to $+85^\circ\text{C}$
Storage Temperature Range	$-65^\circ\text{C}$ to $+150^\circ\text{C}$
Junction Temperature	$+150^\circ\text{C}$
Lead Temperature (soldering, 10s)	$+300^\circ\text{C}$
Soldering Temperature (reflow)	$+260^\circ\text{C}$

Stresses beyond those listed under "Absolute Maximum Ratings" may cause permanent damage to the device. These are stress ratings only, and functional operation of the device at these or any other conditions beyond those indicated in the operational sections of the specifications is not implied. Exposure to absolute maximum rating conditions for extended periods may affect device reliability.

## PACKAGE THERMAL CHARACTERISTICS (Note 1)

TDFN

Junction-to-Ambient Thermal Resistance ( $\theta_{JA}$ ) ..... 83.9 $^\circ\text{C}/\text{W}$

Junction-to-Case Thermal Resistance ( $\theta_{JC}$ ) ..... 37 $^\circ\text{C}/\text{W}$

**Note 1:** Package thermal resistances were obtained using the method described in JEDEC specification JESD51-7, using a four-layer board. For detailed information on package thermal considerations, refer to [www.maxim-ic.com/thermal-tutorial](http://www.maxim-ic.com/thermal-tutorial).

## ELECTRICAL CHARACTERISTICS

( $V_{IN} = +2.2\text{V}$  to  $+36\text{V}$ ,  $T_A = -40^\circ\text{C}$  to  $+85^\circ\text{C}$ , unless otherwise noted. Typical values are at  $V_{IN} = +5.0\text{V}$  and  $T_A = +25^\circ\text{C}$ .) (Note 2)

PARAMETER	SYMBOL	CONDITIONS	MIN	TYP	MAX	UNITS
Input Voltage	$V_{IN}$		2.2		36	V
Preset Regulated Output Voltage	$V_{PROV}$	$I_{OUT} = 0\text{mA}$ , $V_{IN} = 6.5\text{V}$	4.85	5.15	5.45	V
		$I_{OUT} = 200\text{mA}$ , $V_{IN} = 6.5\text{V}$	4.75	5.15	5.45	
		$I_{OUT} = 800\text{mA}$ , $V_{IN} = 6\text{V}$ (Note 3)	4.75	5.15	5.45	
Output Voltage	$V_{OUT}$	$I_{OUT} = 0\text{mA}$ , $V_{IN} > V_{PROV}$		$V_{PROV}$		V
		$I_{OUT} = 0\text{mA}$ , $V_{IN} < V_{PROV}$ (Note 4)		$V_{IN}$		V
Overvoltage Lockout Cutoff Threshold Rising	$V_{OVLO}$	IN rising	7.44	8	8.56	V
Overvoltage Lockout Hysteresis		% of typ $V_{OVLO}$		1		%
Input Supply Current	$I_{IN}$	$\overline{EN} = \text{low}$ , $V_{IN} = 4.5\text{V}$ , $I_{OUT} = 0\text{mA}$		120	260	$\mu\text{A}$
		$\overline{EN} = \text{low}$ , $V_{IN} = 7\text{V}$ , $I_{OUT} = 0\text{mA}$		300	550	
Input Shutdown Current	$I_{IN\_Q}$	$\overline{EN} = \text{high}$ , $V_{IN} = 3\text{V}$		2.5	5	$\mu\text{A}$
OUT Shutdown Current		$V_{IN} = 5\text{V}$ , $V_{OUT} = 4\text{V}$ , $\overline{EN} = \text{high}$	-1		+1	$\mu\text{A}$
On-Resistance	$R_{ON}$	$V_{IN} = 4.75\text{V}$ , $I_{OUT} = 100\text{mA}$			280	$\text{m}\Omega$
LDO Load Capacitance		$I_{OUT}$ up to 0.8A		10		$\mu\text{F}$
<b>DIGITAL SIGNALS (<math>\overline{EN}</math>, <math>\overline{ACOK}</math>)</b>						
$\overline{EN}$ Input High Voltage	$V_{IH}$		1.4			V
$\overline{EN}$ Input Low Voltage	$V_{IL}$				0.4	V
$\overline{EN}$ Input Leakage Current	$I_{LEAK}$	$\overline{VEN} = 0\text{V}$ or $5.5\text{V}$	-150		+150	nA
$\overline{ACOK}$ Output Low Voltage	$V_{OL}$	$V_{IO} = 3.3\text{V}$ , $I_{SINK} = 1\text{mA}$ (see <i>Typical Operating Circuit</i> )			0.4	V
$\overline{ACOK}$ Leakage Current		$V_{IO} = 3.3\text{V}$ , $\overline{ACOK}$ deasserted (see <i>Typical Operating Circuit</i> )	-200		+200	nA

# 36V-Capable Overvoltage Protector with Regulated Output Voltage

MAX14562

## ELECTRICAL CHARACTERISTICS (continued)

( $V_{IN} = +2.2V$  to  $+36V$ ,  $T_A = -40^{\circ}C$  to  $+85^{\circ}C$ , unless otherwise noted. Typical values are at  $V_{IN} = +5.0V$  and  $T_A = +25^{\circ}C$ .) (Note 2)

PARAMETER	SYMBOL	CONDITIONS	MIN	TYP	MAX	UNITS
<b>TIMING CHARACTERISTICS (Note 4)</b>						
Input Debounce Time	$t_{DEB}$	$V_{IN\_MIN} < V_{IN} < V_{OVLO}$ until charge pump turns on, see Figure 1	10	20	35	ms
$\overline{ACOK}$ Time	$t_{\overline{ACOK}}$	$V_{IN\_MIN} < V_{IN} < V_{OVLO}$ to $\overline{ACOK}$ low until charge pump turns on, see Figure 1	20	40	70	ms
Turn-on Time During Soft-Start	$t_{ON}$	$R_{LOAD} = 100\Omega$ , $C_{LOAD} = 1\mu F$ , $V_{OUT} = 20\%$ of $V_{IN}$ to $80\%$ of $V_{IN}$ , see Figure 1		48		$\mu s$
Overvoltage Turn-Off Time	$t_{OFF}$	$V_{IN} > V_{OVLO}$ to $V_{OUT} = 80\%$ of $V_{PROV}$ , $R_{LOAD} = 100\Omega$ , see Figure 1		1		$\mu s$
<b>THERMAL PROTECTION</b>						
Thermal Shutdown	$T_{SHDN}$			150		$^{\circ}C$
Thermal Hysteresis	$T_{HYST}$			20		$^{\circ}C$

**Note 2:** All devices are 100% production tested at  $T_A = +25^{\circ}C$ . Limits over the operating temperature range are guaranteed by design and not production tested.

**Note 3:** Thermally limited, guaranteed by design, and not production tested.

**Note 4:** In linear mode, as  $I_{OUT}$  increases, the OUT voltage drops due to a voltage across Q1 (see *Functional Diagram*).

**Note 5:** All timing characteristics are measured using 20% and 80% levels unless otherwise specified.

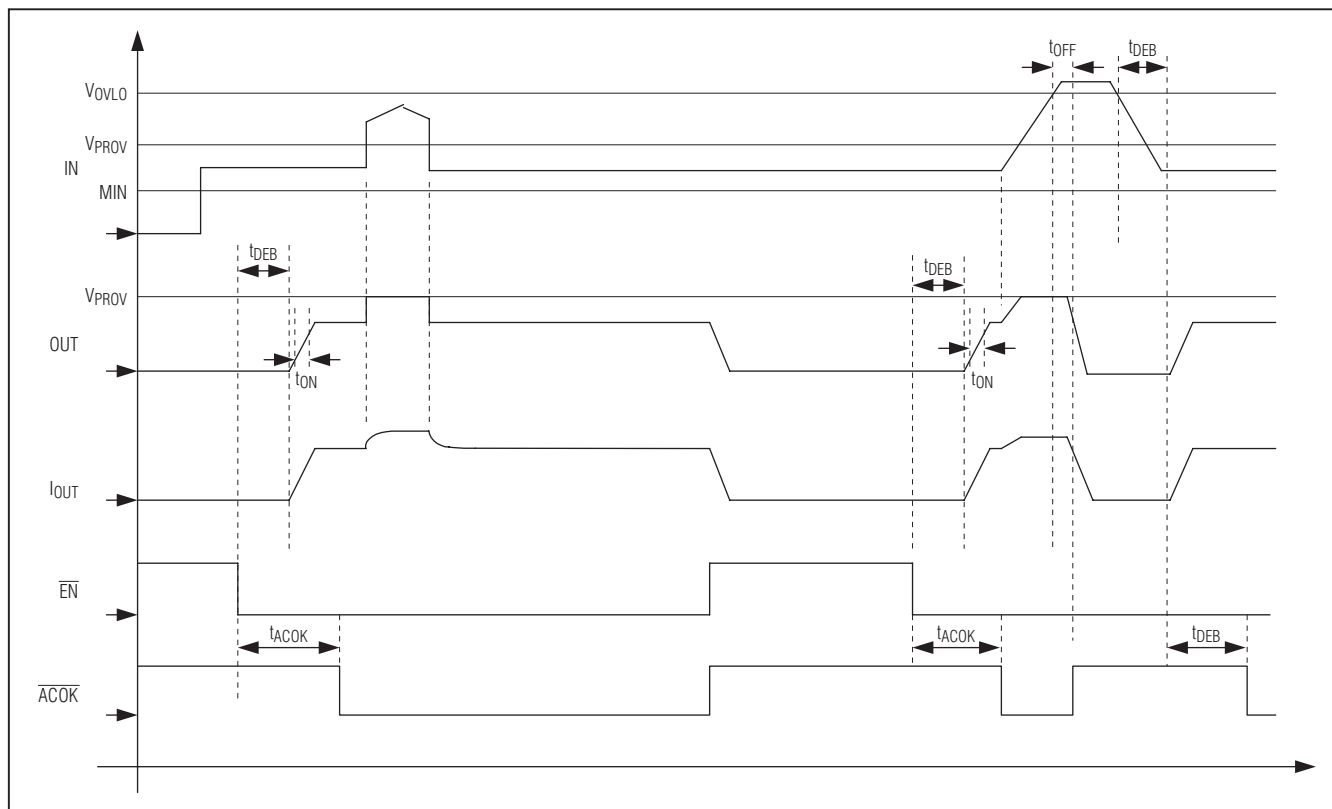
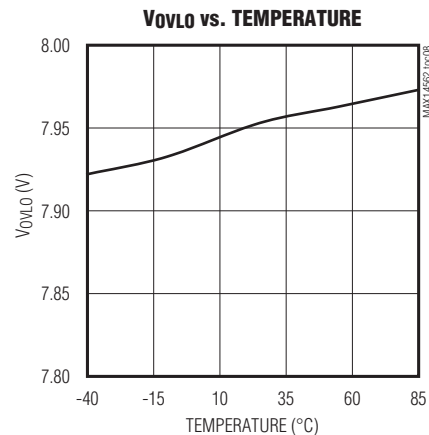
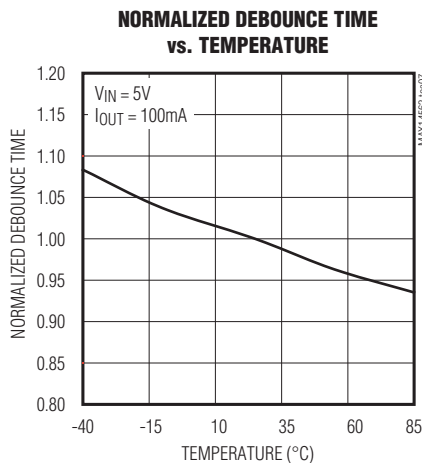
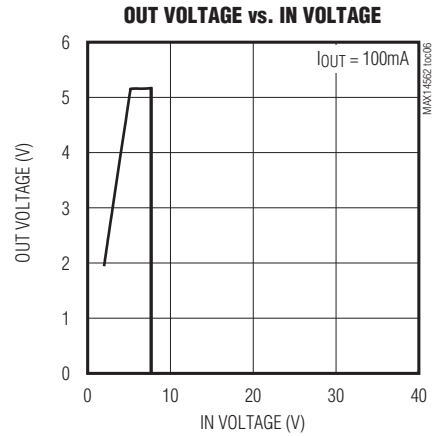
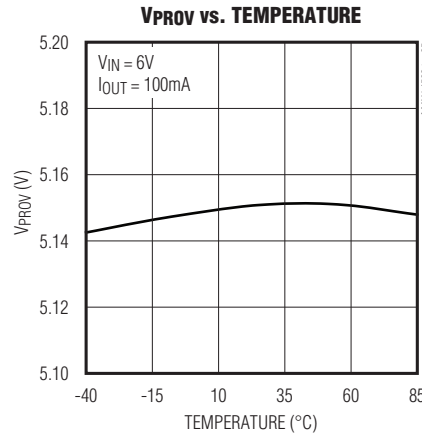
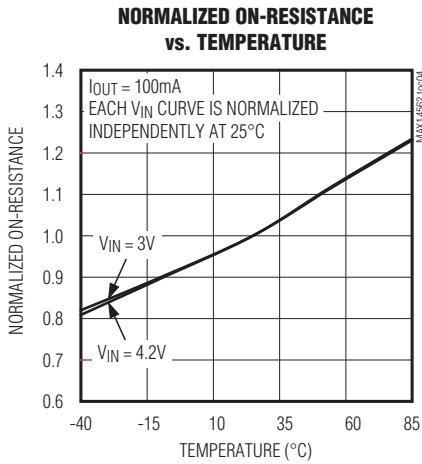
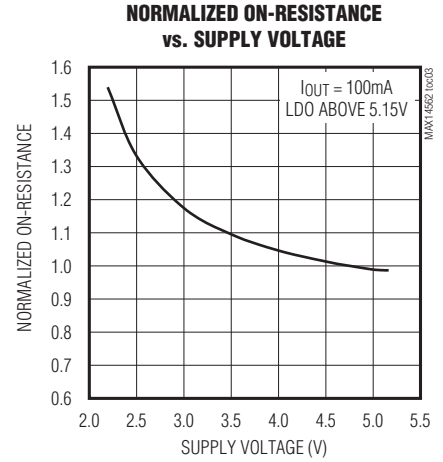
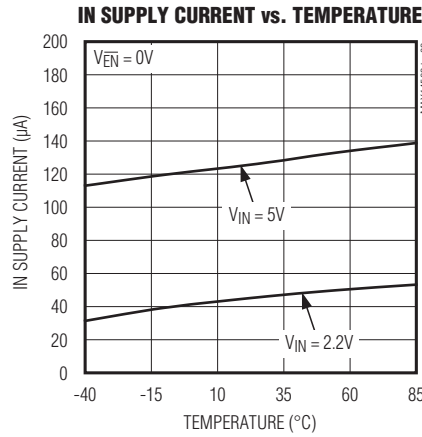
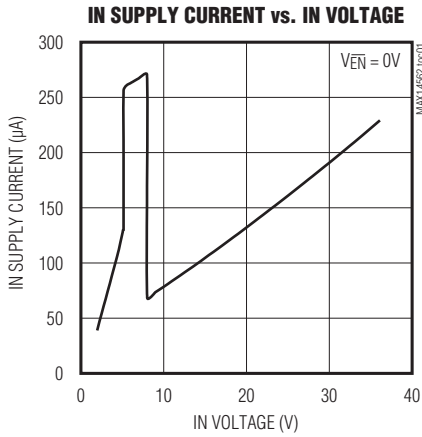

Figure 1. Enable/Select Time

# 36V-Capable Overvoltage Protector with Regulated Output Voltage

## Typical Operating Characteristics

( $C_{IN} = 1\mu F$ ,  $C_{OUT} = 4.7\mu F$ ,  $T_A = +25^\circ C$ , unless otherwise noted.)



# 36V-Capable Overvoltage Protector with Regulated Output Voltage

## Typical Operating Characteristics (continued)

( $C_{IN} = 1\mu\text{F}$ ,  $C_{OUT} = 4.7\mu\text{F}$ ,  $T_A = +25^\circ\text{C}$ , unless otherwise noted.)

MAX14562

**IN RISE TRANSIENT RESPONSE**  
( $I_{OUT} = 10\text{mA}$ )

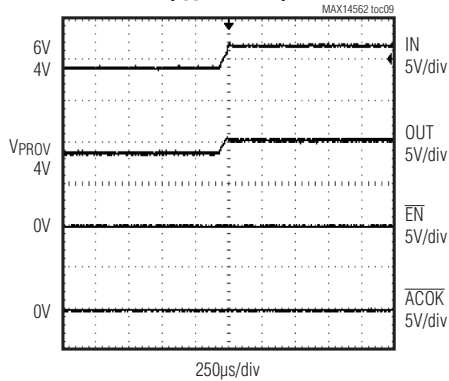

**IN FALL TRANSIENT RESPONSE**  
( $I_{OUT} = 10\text{mA}$ )

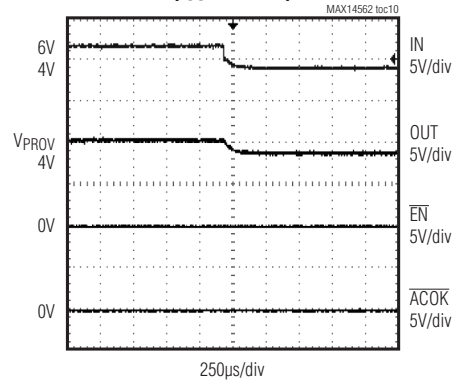

**LOAD TRANSIENT**  
( $V_{EN} = 0\text{V}$ )

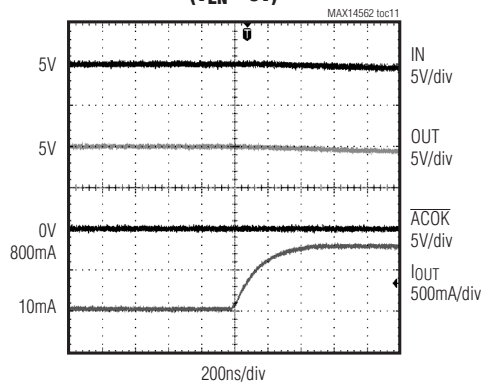

**LOAD TRANSIENT**  
( $V_{EN} = 0\text{V}$ )

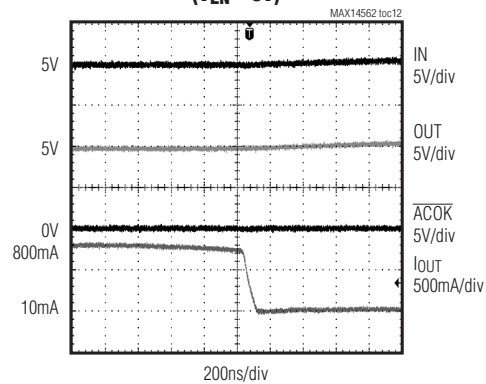

**SWITCH TURN-ON TIME RESPONSE**  
( $R_{LOAD} = 100\Omega$ )

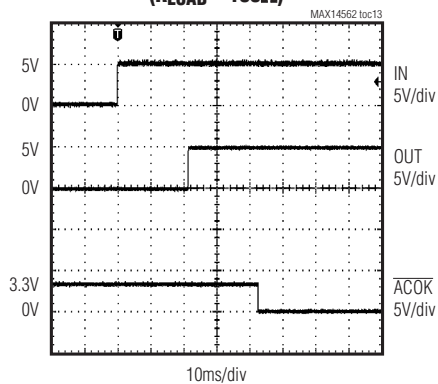

**SWITCH TURN-OFF TIME RESPONSE**  
( $R_{LOAD} = 100\Omega$ )

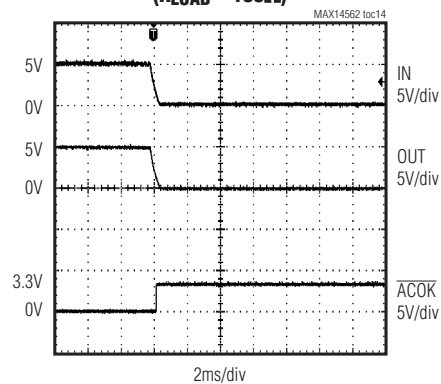

# 36V-Capable Overvoltage Protector with Regulated Output Voltage

## Typical Operating Characteristics (continued)

(C<sub>IN</sub> = 1μF, C<sub>OUT</sub> = 4.7μF, T<sub>A</sub> = +25°C, unless otherwise noted.)

**POWER-UP RESPONSE  
(C<sub>LOAD</sub> = 470μF)**

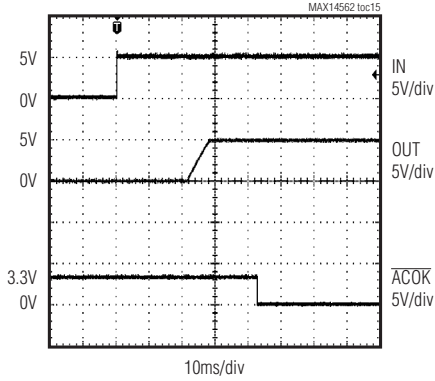

**POWER-UP RESPONSE  
(C<sub>LOAD</sub> = 470μF)**

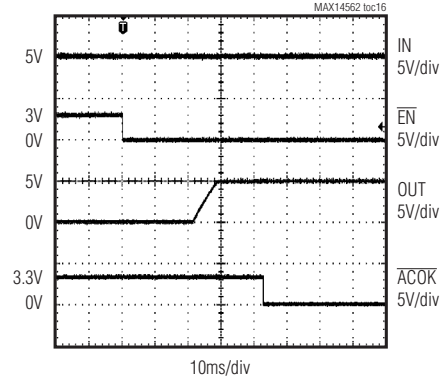

**ACOK RESPONSE (OVERVOLTAGE CONDITION)  
(R<sub>LOAD</sub> = 50Ω)**

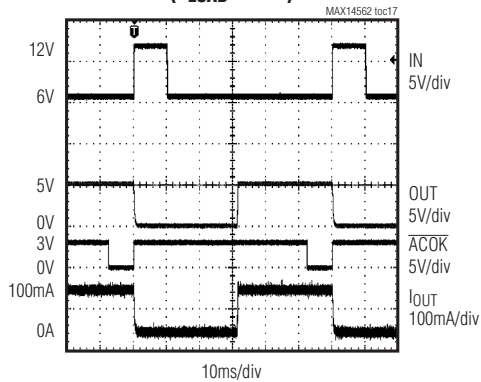

**OUT SHORT SHUTDOWN  
(THERMAL)**

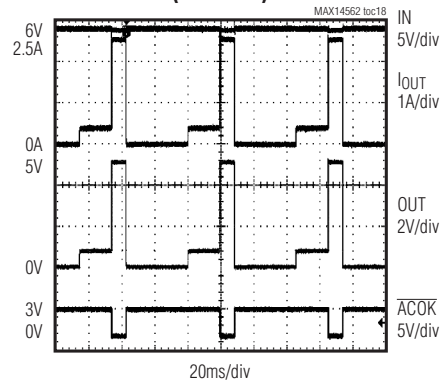

# 36V-Capable Overvoltage Protector with Regulated Output Voltage

## Pin Configuration

**MAX14562**

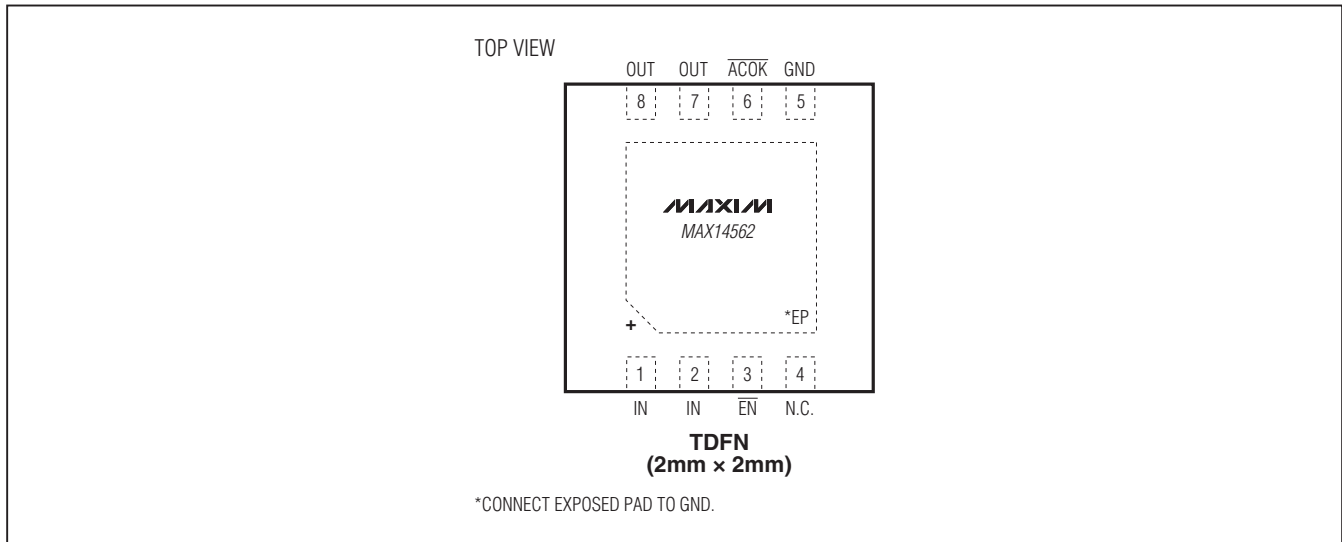

## Pin Description

PIN	NAME	FUNCTION
1,2	IN	Overvoltage Protection Input. Bypass IN with a 1 $\mu$ F ceramic capacitor to get $\pm$ 15kV HBM ESD protection. No capacitor is required for $\pm$ 2kV HBM ESD protection. Externally connect both IN pins together.
3	$\overline{\text{EN}}$	Active-Low Enable Input. Drive $\overline{\text{EN}}$ low to turn on the device. Drive $\overline{\text{EN}}$ high to turn off the device.
4	N.C.	No Connection. Not internally connected.
5	GND	Ground
6	$\overline{\text{ACOK}}$	Open-Drain Flag Output. $\overline{\text{ACOK}}$ is driven low after input voltage is stable between minimum $V_{\text{IN}}$ and $V_{\text{OVLO}}$ after soft-start time (double of debounce time). Connect a pullup resistor from $\overline{\text{ACOK}}$ to the logic I/O voltage of the host system.
7,8	OUT	Overvoltage Protection Output. Bypass OUT with a 1 $\mu$ F or larger ceramic capacitor (see Table 1). Externally connect both OUT pins together.
—	EP	Exposed Pad. Connect EP to GND.

# 36V-Capable Overvoltage Protector with Regulated Output Voltage

## Functional Diagram

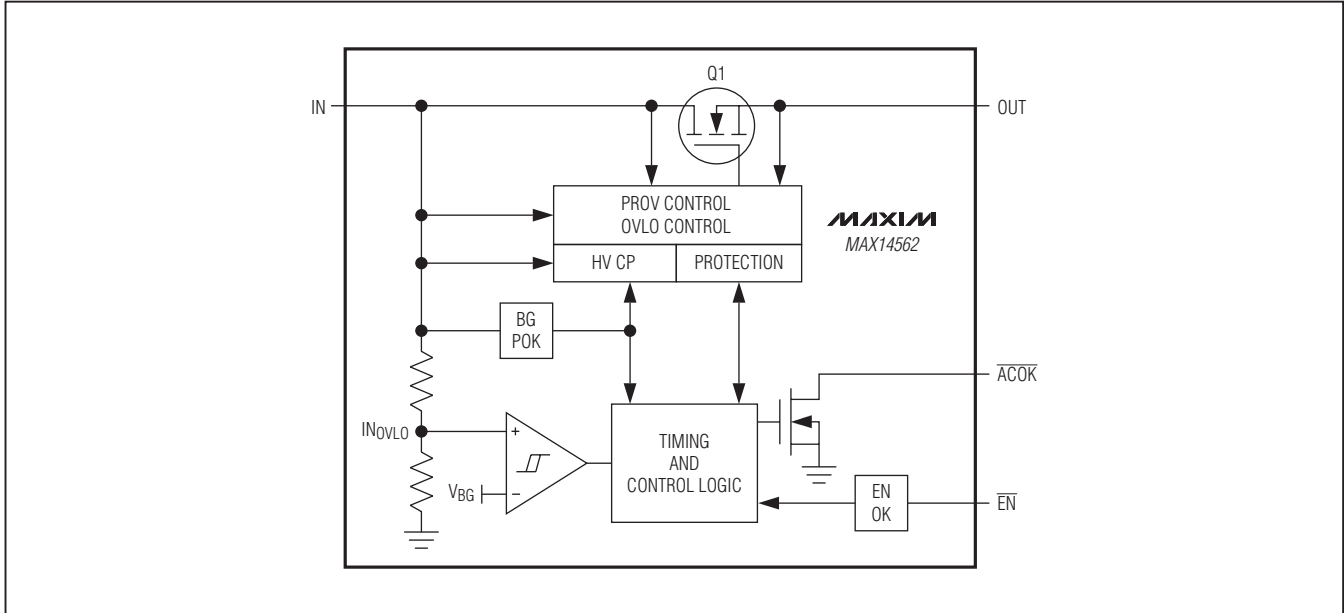

### Detailed Description

The MAX14562 features the overvoltage protection to the charger input  $V_{BUS}$  line when a travel adapter (TA) is used. In addition, the MAX14562 features a low 160m $\Omega$  (typ) on-resistance internal FET (Q1) and protects the low-voltage system against voltage faults up to +36V.

The MAX14562 features three-step overvoltage protection. When the input is below the preset regulated output-voltage ( $V_{PROV}$ ) threshold, the output follows the input minus the voltage drop across the pass FET ( $R_{ON} \times I_{LOAD}$ ). When the input exceeds  $V_{PROV}$ , the output is regulated to  $V_{PROV}$ . If the input rises further and exceeds the overvoltage lockout cutoff ( $V_{OVLO}$ ) threshold, the output is disconnected from the input. The MAX14562 also features thermal shutdown protection against short-circuit events.

### Soft-Start

To minimize inrush current, the MAX14562 features a soft-start capability to slowly turn on Q1.

Soft-start function permits the device to charge the load capacitor up to 1000 $\mu$ F by controlled current. The soft-start is initiated when the debounce time ends (OUT

starts charging) and ends when  $\overline{ACOK}$  is asserted low, 15ms (typ).

### Linear Mode

When the input voltage exceeds the minimum IN voltage but is below  $V_{PROV}$ , OUT follows IN with a minimum voltage drop ( $R_{ON} \times I_{LOAD}$ ) across pass FET after the debounce time,  $t_{DEB}$ , and  $\overline{ACOK}$  is asserted.

The LDO mode needs a capacitor on OUT. The recommended value is 10 $\mu$ F for load currents up to 800mA (Table 1).

### Preset Regulated Output-Voltage Mode (PROV)

When IN goes above the preset regulated output voltage ( $V_{PROV}$ ), Q1 provides a constant voltage of  $V_{PROV}$  at OUT, and  $\overline{ACOK}$  is asserted.

**Table 1. Recommended Load Capacitance**

LOAD CURRENT (mA)	LOAD CAP ( $\mu$ F)
10	1
50	2.2
100	4.7
800	10



# 36V-Capable Overvoltage Protector with Regulated Output Voltage

MAX14562

## Overvoltage Lockout Mode (OVLO)

When IN goes above the overvoltage lockout threshold (VOVLO), OUT is disconnected from IN and  $\overline{\text{ACOK}}$  is deasserted. Power dissipation increases when the input goes higher than VPROV. The overvoltage lockout threshold is set to further the power dissipation. When IN drops below VOVLO, the debounce time starts counting. After the debounce time ( $2 \times t_{\text{DEB}}$ ), OUT follows IN again and  $\overline{\text{ACOK}}$  is asserted.

## Thermal Shutdown

The MAX14562 features a thermal shutdown function necessary to protect the device. The device turns off and  $\overline{\text{ACOK}}$  is deasserted when the junction temperature exceeds  $+150^{\circ}\text{C}$  (typ). When the temperature drops  $20^{\circ}\text{C}$  (typ) below  $150^{\circ}\text{C}$  (typ), the device turns back on and Q1 is turned on after the debounce time.

## Applications Information

### Power-Supply Decoupling

Bypass IN pin(s) to ground with a  $1\mu\text{F}$  or larger ceramic capacitor placed as close as possible to the device.

## Chip Information

PROCESS: BiCMOS

## Package Information

For the latest package outline information and land patterns, go to [www.maxim-ic.com/packages](http://www.maxim-ic.com/packages). Note that a "+", "#", or "-" in the package code indicates RoHS status only. Package drawings may show a different suffix character, but the drawing pertains to the package regardless of RoHS status.

PACKAGE TYPE	PACKAGE CODE	OUTPUT NO.	LAND PATTERN NO.
8 TDFN-EP	T822+1	<a href="#">21-0168</a>	<a href="#">90-0064</a>

# 36V-Capable Overvoltage Protector with Regulated Output Voltage

## Revision History

REVISION NUMBER	REVISION DATE	DESCRIPTION	PAGES CHANGED
0	9/10	Initial release	—
1	8/11	Removed SC70 pin information from data sheet. Added additional conditions to Preset Regulated Output Voltage parameter in the <i>Electrical Characteristics</i> table	1, 2, 3, 7, 9

Maxim cannot assume responsibility for use of any circuitry other than circuitry entirely embodied in a Maxim product. No circuit patent licenses are implied. Maxim reserves the right to change the circuitry and specifications without notice at any time. The parametric values (min and max limits) shown in the Electrical Characteristics table are guaranteed. Other parametric values quoted in this data sheet are provided for guidance.

10 **Maxim Integrated Products, 120 San Gabriel Drive, Sunnyvale, CA 94086 408-737-7600**